



INDEX

S.NO.	SECTION NAME	PAGE NO.	AVEILABLE
01.	FLAT BAR	01	1162,1163,1164,1165,1166, 1167,1168,1169,1170,1173, 1174,1175,1177,1178,1321,1323 6016,6017,6018,1319,1320,1322 1324,1328,1329,1330,1331.
02.	INDUSTRIAL		6013,6014,6015.
03.	FLAT BAR 'V' GROOVE		1171
04.	RADIUS FLAT BAR		6010,6011,6021
05.	SQUARE BAR		1315,1316,1317,1318.
06.	HINGE SECTION		3928.
07.	EQUAL ANGLE	02	1346,1347,1348,1349,1350, 1351,1353,1354,1357,1358.
08.	UNEQUAL ANGLE		1497,1498,1499.
09.	ANGLE		1500.
10.	ROUND BAR		1210,1212,1220,1065, 1066,1067,1068,1070,1074.
			1069,1071,1072,1073.
11.	OVAL TUBE		3823.

S.NO.	SECTION NAME	PAGE NO.	SECTION NUMBER
12.	ROUND TUBE	03	1696,1697,1715,1716,1717, 1718,1719,1720,1781,1782, 1783,1784,1785,1786,1787, 1788,1789,1790,1791,1792,1793
13.	ROUND TUBE		1794,1795,1796,1797,1798, 1799,1800,1801,1802,1808, 1813,1815,1818,1819,1821, 1822,1823,1824,1825,1826,1887.
14.	3,SLOT TUBE		3921,3922,3923.
15.	FLUTED TUBE		1726,1727,1749LL,1750M, 1751H,1752, 6012.
16.	ROUND TUBE	04	3921,3922,1827,1828,1829, 1830,1831,1832,1833,1834, 1835,1836,1837,1838,1839, 1840,1812,1725,1730,1698, 1732,1733,1734,1735,1736,1738, 1803,1806,1809,1817,1698,1699.
17.	SQUARE TUBE	05	2180,2181,2183,2184,2185, 2188,2189,2190,2191,2185/A.
18.	RECTANGULAR TUBE		1981,1982,1983,1984,1985, 1986,1978,1979,1980.
19.	RECTANGULAR TUBE		1996,1997,1998,1999,2000, 2001,2002,1987,1988,1989, 1990,1991,1992. 2037,2038,2105,2120.
20.	RECTANGULAR TUBE	06	1993,1994,1995. 2006,2007,2008,2009,20010, 2011.
21.	RECTANGULAR TUBE		2013,2014,2015,2016,2017, 2018,2021,2022,2023,2024, 2025,2026,2027, 2028.
22.	RECTANGULAR TUBE		2046LL,2046L,2046M,2046MH, 2046H,2031,2032,2033,2034, 2035,2036.
23.	RECTANGULAR TUBE	07	2039,2040,2041,2042,2043, 2044,2045,2047,2049, 2050,2051,2052.
24.	RECTANGULAR TUBE		2053,2054,2060. 2103,2108.
25.	'L' TUBE 1 1/2" x 1"	08	2390,2391,2392.
26.	'L' TUBE 2" x 1"		2393,2394,2395.
27.	SINTEX 'H'		2384,2385,2386.
27 (01).	RT		2104.

S.NO.	SECTION NAME	PAGE NO.	SECTION NUMBER
28.	SINTEX 'A'	08	2387,2388,2389.
29.	TAPER HANDLE		2435.
30.	TAPER MEETING		2436.
31.	18X50 HANDLE		2440.
32.	18X50 INTERLOCK	09	2442.
33.	18X50 BEARING BOTTOM		2441.
34.	HANDLE $\frac{3}{4}$ "		2215,2216,2217,2218,2219, 2220, 2221.
35.	TOP BOTTOM $\frac{3}{4}$ "		2224,2225,2226,2227,2228, 2229,2230.
36.	BEARING BOTTOM $\frac{3}{4}$ "		2239,2240,2240H.
37.	MEETING $\frac{3}{4}$ "		2241,2242.
38.	INTERLOCK $\frac{3}{4}$ "	10	2233,2234,2235,2236,2237, 2238.
39.	HANDLE 1 "		2366,2367,2368,2369,4025.
40.	INTERLOCK 1 "		2371,2372.
41.	MEETING 1 "		2377,2378,2379,2380.
42.	BEARING BOTTOM 1 "		2374,2375.
43.	3'X 1' HANDLE		2427.
44.	2 TRACK TOP $\frac{3}{4}$ "	11	2243,2244,2245,2246,2247, 2248,2249,2250.
45.	2 TRACK BOTTOM $\frac{3}{4}$ "		2253,2254,2255,2256,2257, 2258,2259.
46.	3 TRACK TOP $\frac{3}{4}$ "		2262,2263,2264,2265,2266, 2267,2268,2269.
47.	3 TRACK BOTTOM $\frac{3}{4}$ "		2272,2273,2274,2275,2276, 2277,2278,2279.
48.	4 TRACK TOP $\frac{3}{4}$ "	12	2282,2283,2284,2285,2286, 2287,2288,2289.
49.	4 TRACK BOTTOM $\frac{3}{4}$ "		2295,2296,2297,2298,2299.
50.	5 TRACK TOP $\frac{3}{4}$ "		3801.
51.	5 TRACK BOTTOM $\frac{3}{4}$ "		3811.

S.NO.	SECTION NAME	PAGE NO.	SECTION NUMBER
52.	2 TRACK TOP 1 "	12	2501.
53.	2 TRACK BOTTOM 1 "		2504.
54.	3 TRACK TOP 1 "	13	2508.
55.	3 TRACK BOTTOM 1 "		2512.
56.	4 TRACK TOP 1 "		2520.
57.	ARCHITACTURAL		6086.
58.	HOLLOW 3 TRACK BOTTOM		4501.
59.	HOLLOW 2 TRACK BOTTOM		4502.
60.	SINGLE PARTITION 2 " X 1 "		2407,2409,2411.
61.	DOUBLE PARTITION 2 " X 1 "	14	2408,2410,2412.
62.	SINGLE PARTITION 2 ½ " X 1 ½ "		2301,2302,2303,2304,2305, 2306,2307,2308,2309,2310, 2311.
63.	DOUBLE PARTITION 2 ½ " X 1 ½ "		2314,2315,2316.
64.	DOUBLE PARTITION 2 ½ " X 1 ½ "		2317,2318,2319,2320,2321, 2322, 2324,2323.
65.	SINGLE PARTITION 4 " X 1 ¾ "	15	2329,2330,2331,2332
66.	CORNER PARTITION(SAMOSAS)		2432.
67.	DOUBLE PARTITION 4 " X 1 ¾ "		2334,2335,2336,2337.
68.	LEG PARTITION* 2 ½ " X 1 ½ "		2325,2326,2327.
69.	TRIX VERTICAL		2352.
70.	SINGLE LEG DOOR TOP	2419.	
71.	2½ X 1"DOUBLE PARTITION	16	2446.
72.	DOOR BOTTOM		2340,2410,2413,2424.
73.	DOOR TOP		2348,2349,2350,2351.

S.NO.	SECTION NAME	PAGE NO.	SECTION NUMBER
74.	DOOR VERTICAL	16	2344,2345,2347. 2400,2401.
75.	DOOR MIDDLE SINGLE		2409,2354,2355,2356.
76.	DOOR MIDDLE DOUBLE		2359,2360,2361,2411.
77.	STRUCTURE GLAZING	17	2416,2417,2418,2433.
78.	MULLION		2422,3826,3827.
79.	`Z' MULLION		2431,2431L.
80.	HOLLOW `Z' (D)		2423.
81.	'Z' HOLLOW (B)	18	2430,2430L.
82.	'Z' FRAME		2429,2429L.
83.	LAME `Z'		2426.
84.	CLIP		2428,2428L.
85.	ARCHITECTURAL		2451,2452.
86.	ARCHITECTURAL	19	2501,2502,2503.
87.	SQUARE CLIP		2421.
88.	FRAME SECTION		2434.
89.	SPECIAL SECTION		2438.
90.	DOOR GEAR SECTION		2439.
91.	ARCHITECTURAL	20	2447.
92.	ARCHITECTURAL		2456,2457,2458,2460.
93.	ARCHITECTURAL		2463,2464,2466.
94.	ARCHITECTURAL	21	2467,2487,2498,2500.
95.	LOCK SECTION		2510,2511.

S.NO.	SECTION NAME	PAGE NO.	SECTION NUMBER
96.	SINGLE GLASS SECTION	21	3768,3769.
97.	ARCHITECTURAL	22	3770,3727.
98.	C-CHANNEL		3771,3772.
99.	ARCHITECTURAL		3773,3774,3775,3777.
100.	TEXTILE		3776.
101.	ARCHITECTURAL		3778,3779.
102.	ARCHITECTURAL	23	2491,2492,2493,2517.
103.	EXHIBITION		2499
104.	'C' HANDLE		3870,3871,3872,3873.
105.	'D' HANDLE		3819,3820.
106.	'D' HANDLE	24	3822,3821.
107.	ARCHITECTURAL		2414,2399.
108.	ARCHITECTURAL		3950,3955,2486
109.	ARCHITECTURAL		2398,2425.
110.	ARCHITECTURAL	25	2414,2448,2420.
111.	ARCHITECTURAL		2506,2507,2508,2509.
112.	OVAL TUBE		2444.
113.	TRISUL SECTION	26	2445..
114.	ARCHITECTURAL		2450.
115.	GLAZING CLIP		2404,2405,2406.
116.	GLASS SECTION(HATHI)		2364.
117.	FRAME SECTION		2484.
118.	SUB FRAME		2443.

S.NO.	SECTION NAME	PAGE NO.	SECTION NUMBER
119.	SUB FRAME	27	2552,2553,2554,2555,2556.
120.	LOUVER		2449,2558.
121.	ARCHITECTURAL	28	3784,2521,2540,2543, 2544,2545,6098,2547
122.	ARCHITECTURAL	29	2548,2549,2550,2551,2459, 2496,2480,6130
123.	ARCHITECTURAL	30	6131,6132,6133,4507,6073, 6067,6039,6040.
124.	ARCHITECTURAL	31	6036,6005,6006,6000,6001, 6002,6003,6004.
125.	ARCHITECTURAL	32	
126.	HEAT SINK	34	4227,4228,4229,4230, 4224,4222.
127.	HEAT SINK	35	4223,4225,4229,4232,4233.
128.	CURTAIN WALL	36	3822,3823,3824,3825,2541, 2542,2504,2505.
129.	TEXTILE SECTION	37	3622,2455,5055,5054,2453, 2453L,3937,3621,3624, 3620,3932,3940
130.	TEXTILE SECTION	38	3623,3616,3617,3615,3615L, 5056,5057,3618,3619,2115, 3931,2437,3932,3966,3951
131.	TEXTILE SECTION	39	3614,3626,3625,3629, 2111,2497,3776,6153.
132.	CARRIER SECTION	40	3948,3953,3964,3963,3962, 3947.
133.	CARRIER SECTION	41	3942,3965,3934,3935, 3933,3941,3967.
134.	INDUSTRIAL	42	3929,3924,3930,3925.
135.	GEAR BODY		1728

S.NO.	SECTION NAME	PAGE NO.	SECTION NUMBER
136.	EYE-GLASS	42	2461,2462.
137.	ROLLER		3957.
138.	TOWER BOLT		1700,1701,1702,1703,1704, 1705,1706,1707,1709,1710, 1711,1712,1713,1714.
139.	BOARD SECTION	43	2471,2472,3943,3956.
140.	MARUTI LOCK		2396,2397.
141.	BUS BODY		4124.
142.	BULB TEE		1649.
143.	TAPER BAR	44	1179.
144.	FLUTED ANGLE		2485.
145.	A.C.GRILL		2415,3926,3927.
146.	DOOR CLOSER	45	3952,3938,3936,6082,6083.
147.	INDUSTRIAL(MISCELLLANEOUS)	46	5041,5042,6020,6181,6182, 3875,3874.
148.	INDUSTRIAL(MISCELLLANEOUS)	47	4503,4504,4505,4506,4508, 4509,4510,4511,4512,4513.
149.	INDUSTRIAL(MISCELLLANEOUS)	48	4514,4517,4518,6183,6184, 6185,6186.
150.	INDUSTRIAL(MISCELLLANEOUS)	49	6187,6188,6189,6190, 5017,5018.
151.	INDUSTRIAL(MISCELLLANEOUS)	50	5019,5020,5021,5022,5023, 5031,5033,5034.
152.	INDUSTRIAL(MISCELLLANEOUS)	51	5035,5036,5037,5038,5040, 5043,5044,5045.
153.	INDUSTRIAL(MISCELLLANEOUS)	52	5046,5047,5048,5049, 5051,5052,5053,4526.
154.	INDUSTRIAL(MISCELLLANEOUS)	53	5100,5101,5102,5103,5104, 5105,5106,5107.
155.	INDUSTRIAL(MISCELLLANEOUS)	54	5108,5109,6100,6101,6102, 6103,6104,6105.
156.	INDUSTRIAL(MISCELLLANEOUS)	55	6106,6107,6108,6109,6110, 6111,6112,6095.
157.	INDUSTRIAL(MISCELLLANEOUS)	56	6155,6150,6154,6096,6084, 6007,6008,6134.

S.NO.	SECTION NAME	PAGE NO.	SECTION NUMBER
158.	INDUSTRIAL(MISCELLLANEOUS)	57	6009,6010,6011,6191 1722,6016,6017.
159.	INDUSTRIAL(MISCELLLANEOUS)	58	6018,6019,3969/A,3969, 6022,6023,6024,6025.
160.	INDUSTRIAL(MISCELLLANEOUS)	59	6026,6027,6028,6029,6030, 6031,6032,6033.
161.	INDUSTRIAL(MISCELLLANEOUS)	60	6034,6085,6037,6038,6194, 6176,6041,6042.
162.	INDUSTRIAL(MISCELLLANEOUS)	61	6043,6045,6060,6061,6062, 6063,6064,2482.
163.	INDUSTRIAL(MISCELLLANEOUS)	62	6066,6087,6068,6069,6070, 6071,6072,6097,4520.
164.	INDUSTRIAL(MISCELLLANEOUS)	63	6151,6152,6154,6155,6175, 6180,6177.
165.	INDUSTRIAL(MISCELLLANEOUS)	64	6088,6089,6090,6091, 6099,6161,6162.
166.	SOLAR SECTION	65	6158,6156,6157,6094,6093, 6159,6160,4519.
167.	LIFT SECTION	66	2116,2117,2118,2465,2488, 2489,2490,5039.
168.	LIFT SECTION	67	2465.
169.	EXHIBITION SECTION		3949,3944,3945,3946,2454, 2483.
170.	INDUSTRIAL(MISCELLLANEOUS)	68	2494,2420,2468,2469,2573,2476.
171.	INDUSTRIAL(MISCELLLANEOUS)	69	2478,2479,2481,2495,2514,2517 1721,2531.
172.	INDUSTRIAL(MISCELLLANEOUS)	70	2314,2559,2562,3627,3780, 3782,3783,6075.
173.	INDUSTRIAL(MISCELLLANEOUS)	71	3960,3961,3968,4521,4524, 4525,1816,1325.
174.	INDUSTRIAL(MISCELLLANEOUS)	72	1326,5035,6040,6074,6065, 6166,6163,6164.
175.	INDUSTRIAL(MISCELLLANEOUS)	73	6165.
176.	INDUSTRIAL(MISCELLLANEOUS)	74	6171,6172,6173,6174,3828,6197.

HARDWARE

Flat Bar



Sr. No	Section No.	A (mm)	T (mm)	Weight(Kg./Mtr)	Weight(Kg./12')
1	1162	16.90	3.90	0.21	0.65-0.75
2	1163	19.00	5.00	0.27	0.90-1.00
3	1164	25.00	5.00	0.36	1.20-1.30
4	1165	125.00	6.00	2.30	7.40-8.40
5	1166	17.00	4.20	0.21	0.70-0.75
6	1167	75.00	10.00	2.30	7.40-8.40
7	1168	50.00	10.00	1.39	5.00-5.10
8	1169	40.00	10.00	1.12	4.00-4.10
9	1170	34.00	2.00	0.19	0.65-0.70
10	1173	25.00	10.00	0.74	2.400-2.700
11	1174	32.00	2.50	0.25	0.80-0.90
12	1175	12.00	5.00	0.19	0.550-0.700
13	1177	19.00	2.75	0.16	0.500-0.600
14	1178	19.00	3.60	0.22	0.675-0.800
15	6016	64.8	0.80	0.17	0.510-0.610
16	6017	79.75	0.80	0.20	0.630-0.730
17	6018	97.60	0.80	0.24	0.770-0.870
18	1320	25.40	38.10	2.64	9.565-9.665
19	1319	25.40	50.80	3.51	12.750-12.850
20	1321	75.0	3.0	0.601	2.200-2.500
21	1322	100.0	12.0	3.240	11.850-12.050
22	1323	50.0	6.0	0.806	2.950-3.150
23	1324	100.0	10.0	2.700	9.880-10.080
24	1331	38.0	3.0	0.306	1.225-1.425
25	1328	32.0	12.70	1.090	4.000-4.200
26	1329	40.0	16.0	1.725	6.300-6.500
27	1330	32.0	16.0	1.380	5.050-5.250



Sr. No	Section No.	A (mm)	B (mm)	T (mm)	Weight(Kg./Mtr)	Weight(Kg./12')
1	6013	64.8	3.5	0.8	1.00	0.560-0.660Kg./12'
2	6014	79.75	3.5	0.8	0.186	0.680-0.830Kg./12'
3	6015	97.60	3.5	0.8	0.224	0.820-0.970Kg./12'

Flat Bar 'V' Groove



Sr. No	Section No.	A (mm)	T (mm)	Weight(Kg./Mtr)	Weight(Kg./12')
1	1171	29.00	5.40	0.410	1.50-1.60

RADIUS FLAT BAR

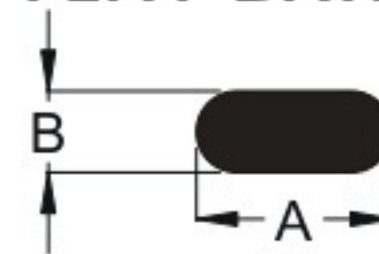

Sr. No	Section No.	A (mm)	B (mm)	Weight(Kg./Mtr)	Weight(Kg./12')
1	6021	12.00	5.00	0.148	0.540-0.610
2	6010	16.60	6.00	0.238	0.870-0.970
3	6011	19.90	6.00	0.301	1.100-1.200

SQUARE BAR



Sr. No	Section No.	A (mm)	B (mm)	Weight(Kg./Mtr)	Weight(Kg./12')
1	1315	19.00	19.00	1.00	3.570-3.670
2	1316	25.40	25.40	1.77	6.375-6.475
3	1317	31.75	31.75	2.75	9.960-10.060
4	1318	38.10	38.10	3.95	14.345-14.445

Hinge Section

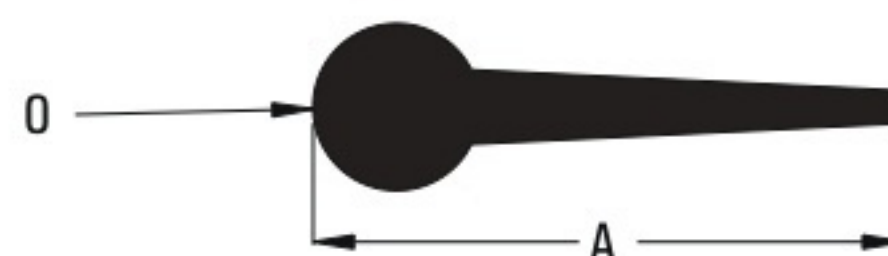

Sr. No	Section No.	A (mm)	O (mm)	Weight(Kg./Mtr)	Weight(Kg./12')
1	3928	17.50	3.80	0.068	0.25-0.50

ROUND BAR

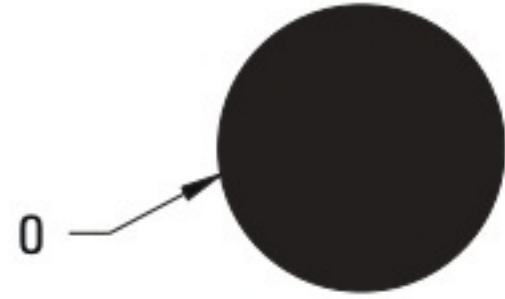

Sr. No	Section No.	O (mm)	I (mm)	Weight(Kg./Mtr)	Weight(Kg./12')
1	1210	22.00	—	1.012	3.700-4.000
2	1212	25.00	—	1.312	4.800-5.100
3	1220	37.00	—	2.898	10.600-11.100
4	1065	19.00	—	0.765	2.800-3.000
5	1066	15.60	—	0.519	1.900-2.050
6	1067	11.70	—	0.289	1.060-1.080
7	1068	9.05	—	0.174	0.635-0.660
8	1070	16.00	—	0.541	1.980-2.150
9	1074	22.20	—	1.046	3.825-3.975
10	1212	25.40	—	1.367	5.000-5.250

Equal Angle

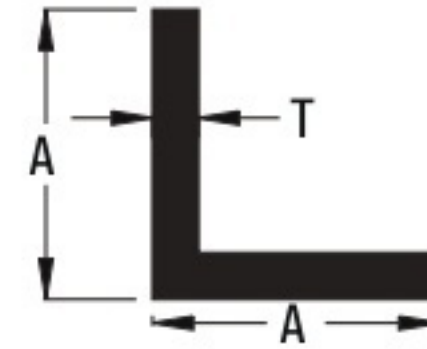

Sr. No	Section No.	A (mm)	T (mm)	Weight(Kg./Mtr)	Weight(Kg./12')
1	1346	38.00	3.00	0.574	2.10-2.30
2	1347	25.00	1.70	0.218	0.80-1.00
3	1348	100.00	6.20	3.239	11.85-11.95
4	1349	38.00	1.20	0.232	0.85-0.95
5	1350	38.00	2.50	0.492	1.80-1.90
6	1351	38.00	4.00	0.765	2.80-3.00
7	1353	50.00	5.90	1.503	5.50-5.70
8	1354	19.00	2.00	0.191	0.70-0.80
9	1357	50.00	4.70	1.202	4.40-4.60
9	1358	100.0	3.0	1.599	5.85-6.05

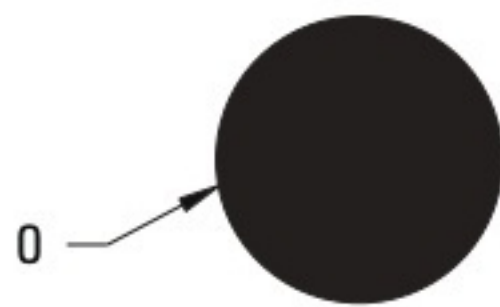

Sr. No	Section No.	O (mm)	I (mm)	Weight(Kg./Mtr)	Weight(Kg./12')
1	1068	28.00	—	1.668	6.100-6.300
2	1069	31.80	—	2.146	7.850-8.000
3	1070	32.00	—	2.160	7.900-8.100
4	1071	38.10	—	3.089	11.300-11.500
5	1072	40.00	—	3.390	12.400-12.600
6	1073	10.00	—	0.212	0.775-0.875

Unequal Angle

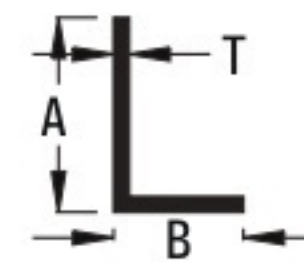

Sr. No	Section No.	A (mm)	B (mm)	T (mm)	Weight(Kg./Mtr)	Weight(Kg./12')
1	1497	38.00	25.00	2.10	0.355	1.30-1.40
2	1498	38.00	25.00	2.60	0.410	1.50-1.70
3	1499	25.00	12.00	1.50	0.054	0.200-0.300

OVAL TUBE

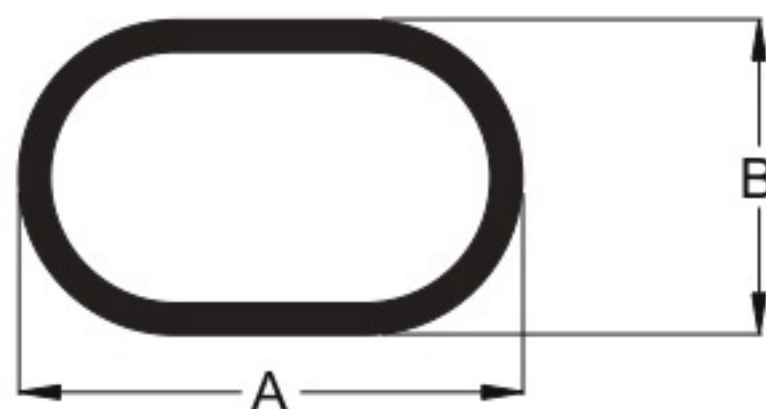

Sr. No	Section No.	A (mm)	B (mm)	T (mm)	Weight(Kg./Mtr)	Weight(Kg./12')
1	3823	16.00	10.00	1.00	0.109	0.400-0.500/12'

Angle

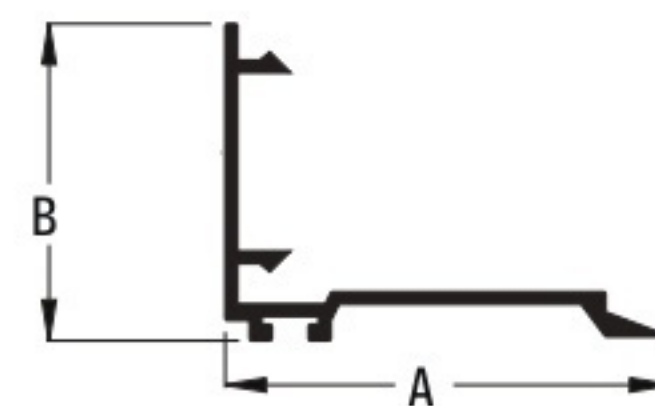

Sr. No	Section No.	A (mm)	B (mm)	T (mm)	Weight(Kg./Mtr)	Weight(Kg./12')
1	1500	54.80	39.0	1.50	0.478	1.750-1.900/12'

Round Tube

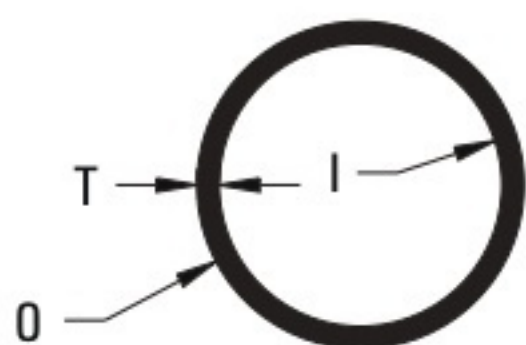

Sr. No	Section No.	O (mm)	I (mm)	T (mm)	Weight(Kg./Mtr)	Weight(Kg./12')
1	1696	28.5	20.5	4.0	0.834	3.050-3.250
2	1697	25.5	13.5	6.0	0.984	3.600-3.800
3	1715	18.5	10.5	4.0	0.492	1.800-2.000
4	1716	40.00	36.00	2.0	0.645	2.360-2.560
5	1717	60.0	56.0	2.0	0.984	3.600-3.800
6	1718	70.0	66.0	2.0	1.154	4.220-4.420
7	1719	80.0	76.0	2.0	1.203	4.840-5.040
8	1720	100.0	96.0	2.0	1.663	6.080-6.280
9	1781	29.6	28.4	0.60	0.148	0.540-0.580
10	1782	38.00	34.00	2.00	0.601	2.20-2.40
11	1783	60.00	57.00	1.50	0.738	2.70-2.90
12	1784	73.00	69.00	2.00	1.094	4.00-4.400
13	1785	10.00	8.00	1.00	0.076	0.280-0.330
14	1786	23.00	12.00	5.50	0.820	3.00-3.300
15	1787	101.6	93.6	4.00	3.308	12.100-13.00
16	1788	27.20	21.80	2.70	0.547	2.00-2.300
17	1789	33.00	21.00	6.00	1.367	5.00-5.400
18	1790	51.30	25.00	13.20	4.238	15.500-16.00
19	1791	25.00	23.50	0.80	0.150	0.550-0.650
20	1792	82.50	76.20	3.15	2.105	7.700-8.200
21	1793	76.20	69.70	3.25	1.996	7.300-7.800

Round Tube

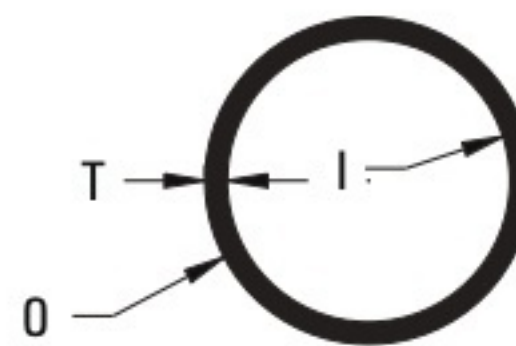

Sr. No	Section No.	O (mm)	I (mm)	T (mm)	Weight(Kg./Mtr)	Weight(Kg./12')
1	1794	60.00	50.00	5.00	2.324	8.500-9.000
2	1795	54.00	34.00	10.00	3.718	13.600-14.300
3	1796	45.00	35.00	5.00	1.695	6.200-6.700
4	1797	40.00	30.00	5.00	1.476	5.400-5.900
5	1798	15.50	14.00	0.75	0.096	0.350-0.450
6	1799	38.00	25.00	6.50	1.722	6.300-6.700
7	1800	50.00	40.00	5.00	1.900	6.950-7.500
8	1801	76.20	73.70	1.25	0.793	2.900-3.200
9	1802	50.50	45.50	2.50	1.011	3.700-3.900
10	1808	76.00	63.00	6.50	3.828	14.000-14.350
11	1813	37.49	34.95	1.27	0.383	1.400-1.700
12	1815	51.28	47.62	1.82	0.765	2.800-3.000
13	1818	45.00	25.00	10.00	2.953	10.800-11.100
14	1819	88.90	82.90	3.00	2.187	8.000-8.300
15	1821	64.20	51.40	6.40	3.130	11.450-11.750
16	1822	57.70	51.30	3.20	1.463	5.350-5.650
17	1823	33.30	22.30	5.50	1.285	4.700-5.000
18	1824	51.30	45.00	3.15	1.285	4.700-5.000
19	1825	37.60	35.30	1.15	0.355	1.300-1.500
20	1826	45.00	25.40	9.80	2.925	10.700-11.100
21	1887	101.60	93.60	4.00	3.308	12.100-12.500

3,Slot Tube

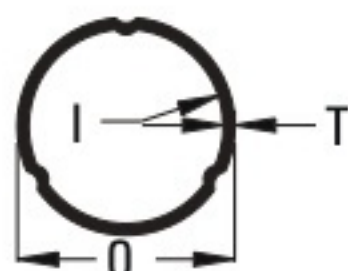

Sr. No	Section No.	O (mm)	I (mm)	T (mm)	Weight(Kg./Mtr)	Weight(Kg./12')
1	3921	36.00	32.00	1.70	0.478	1.75-1.85
2	3922	32.00	28.00	1.65	0.424	1.55-1.65
3	3923	42.00	38.00	2.10	0.683	2.50-2.70

Fluted Tube

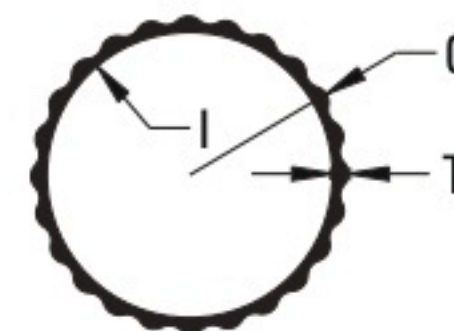

Sr. No	Section No.	O (mm)	I (mm)	T (mm)	Weight(Kg./Mtr)	Weight(Kg./12')
1	1749 LL	24.00	22.40	0.80	0.123	0.45-0.65
2	1750 M	24.00	21.60	1.20	0.164	0.60-0.80
3	1751 H	24.00	21.40	1.30	0.105	0.75-0.95
4	1752	28.00	26.10	0.99	0.142	0.65-0.85/15'
5	6012	25.30	25.30	1.75	0.317	1.450-1.600/15'
6	1726	100.00	90.00	5.00	3.609	13.200-13.500
7	1727	125.00	115.00	5.00	4.574	16.730-17.00
8	1731	98.00	91.60	3.20	2.600	9.500-9.900

Round Tube

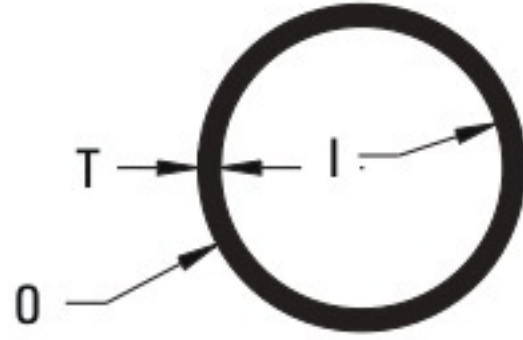

Sr. No	Section No.	O (mm)	I (mm)	T (mm)	Weight(Kg./Mtr)	Weight(Kg./12')
1	3921	38.00	25.20	6.40	1.695	6.200-6.500
2	3922	33.30	21.20	6.05	1.394	5.100-5.400
3	1827	60.00	57.00	1.50	0.738	2.700-2.900
4	1828	63.80	57.70	3.05	1.558	5.700-6.000
5	1829	73.40	69.70	1.85	1.121	4.100-4.300
6	1830	10.00	9.00	0.50	0.041	0.150-0.200
7	1831	125.00	119.00	3.00	3.089	11.300-11.700
8	1832	52.40	25.40	13.50	4.456	16.300-16.800
9	1833	83.00	77.00	3.00	2.023	7.400-7.700
10	1834	76.80	70.60	3.10	1.941	7.100-7.400
11	1835	54.70	34.50	10.10	3.828	14.000-14.400
12	1836	45.60	35.80	4.90	1.695	6.200-6.500
13	1837	40.40	30.50	4.95	1.476	5.400-5.700
14	1838	60.00	50.00	5.00	2.324	8.500-8.800
15	1839	33.30	21.20	6.05	1.394	5.100-5.300
16	1840	50.00	40.00	5.00	1.914	7.000-7.300
17	1812	12.4	10.0	1.20	0.109	0.400-0.500
18	1725	101.0	95.0	3.15	2.488	9.100-10.400
19	1730	162.0	152.0	5.00	6.390	23.400-23.800
20	1698	32.0	29.0	1.5	0.382	1.400-1.600
21	1732	32.0	25.0	3.5	0.848	3.100-3.300
22	1733	38.0	32.0	3.0	0.891	3.260-3.460
23	1734	69.0	63.0	3.0	1.681	6.150-6.350
24	1735	76.0	68.0	4.0	2.446	8.950-9.250
25	1736	25.0	5.0	10.0	1.274	4.660-4.860
26	1803	42.0	37.0	2.5	0.790	2.900-3.300
27	1806	25.4	19.4	3.0	0.530	1.950-2.450
28	1809	35.0	25.0	5.0	1.274	4.600-5.100
29	1817	25.2	21.2	2.0	0.680	2.500-2.700
30	1698	32.0	29.0	1.50	0.382	1.400-1.600
31	1699	11.9	8.30	1.80	0.153	0.560-0.660
32	1732	102.0	95.0	3.5	3.007	10.700 - 11.000

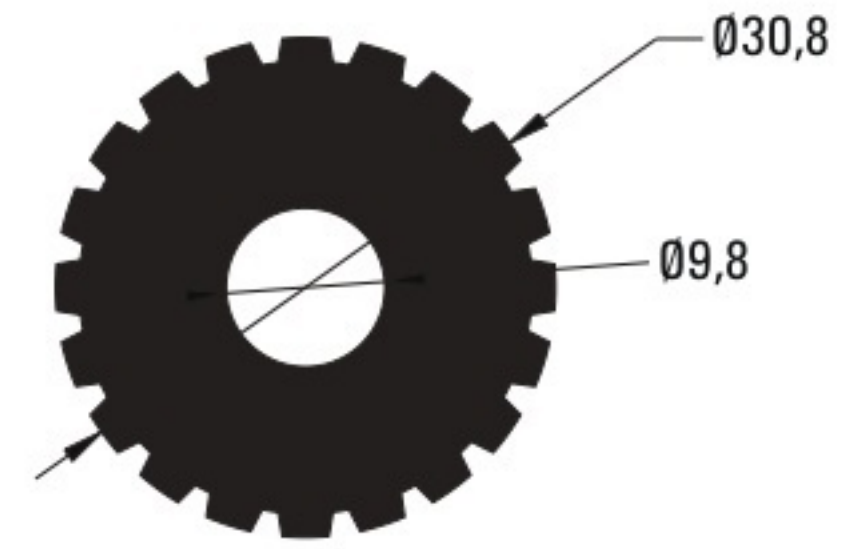

Sr. No	Section No.	A (mm)	B (mm)	T (mm)	Weight(Kg./Mtr)	Weight(Kg./12')
1	1738	---	---	---	1.681	6.150-6.350

ARCHITECTURAL

Square Tube

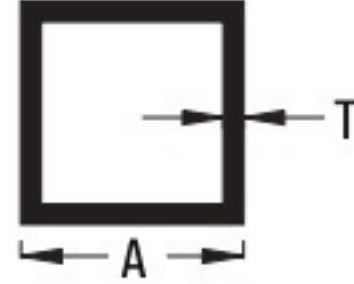

Sr. No	Section No.	A (mm)	T (mm)	Weight(Kg./Mtr)	Weight(Kg./12')
1	2180	19.00	1.00	0.191	0.700-0.800
2	2181	25.00	0.95	0.246	0.90-1.00
3	2183	25.00	1.50	0.283	1.40-1.60
4	2184	38.10	1.40	0.547	2.00-2.00
5	2185	38.10	1.80	0.711	2.60-3.00
6	2188	50.00	1.15	0.601	2.20-2.400
7	2189	50.00	1.35	0.711	2.60-2.80
8	2190	80.00	2.50	2.091	7.65-7.95
9	2191	100.00	3.00	3.144	11.50-11.80
10	2185/A	38.1	1.20	0.459	1.679-1.879

Rectangular Tube

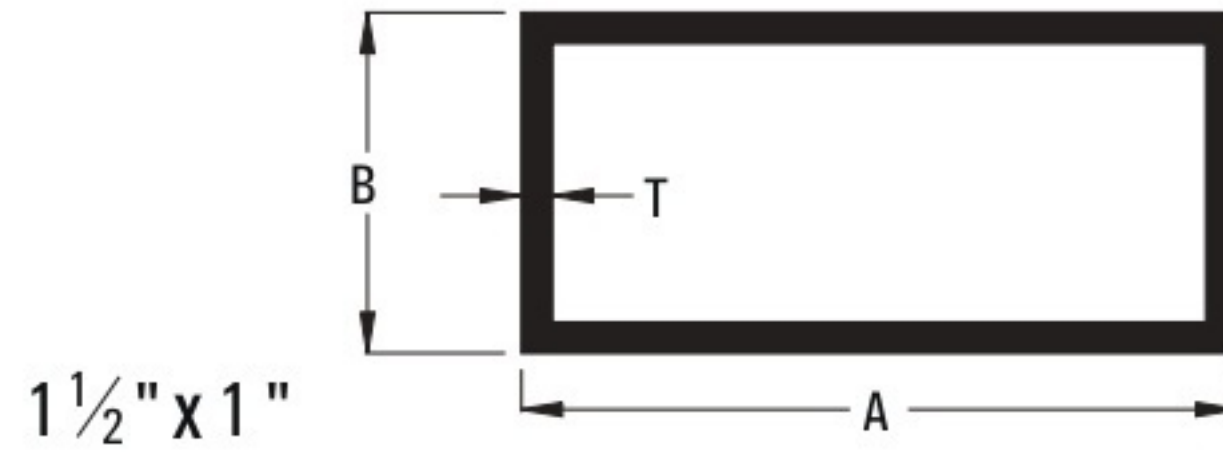

Sr. No	Section No.	A (mm)	B (mm)	T (mm)	Weight(Kg./Mtr)	Weight(Kg./12')
1	1996	38.10	25.4	0.60	0.191	0.70-0.85
2	1997	38.10	25.4	0.70	0.232	0.85-1.00
3	1998	38.10	25.4	0.90	0.301	1.10-1.30
4	1999	38.10	25.4	1.10	0.383	1.40-1.60
5	2000	38.10	25.4	1.35	0.437	1.60-1.80
6	2001	38.10	25.4	1.50	0.492	1.80-2.00
7	2002	38.10	25.4	2.25	0.711	2.60-2.80

Rectangular Tube

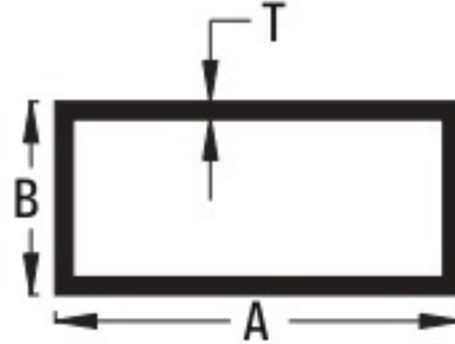

Sr. No	Section No.	A (mm)	B (mm)	T (mm)	Weight(Kg./Mtr)	Weight(Kg./12')
1	1981	40.00	20.00	2.00	0.601	2.200-2.500
2	1982	25.00	19.00	1.35	0.301	1.100-1.200
3	1983	25.00	12.70	0.70	0.137	0.50-0.70
4	1984	25.00	12.70	1.05	0.205	0.75-0.85
5	1985	25.00	12.70	1.25	0.232	0.850-0.950
6	1986	25.00	12.70	1.40	0.260	0.950-1.050
7	1978	50.80	38.10	1.70	0.765	2.800-3.00
8	1979	100.00	18.00	1.40	0.875	3.20-3.400
9	1980	75.00	18.00	1.40	0.656	2.40-2.600

Rectangular Tube

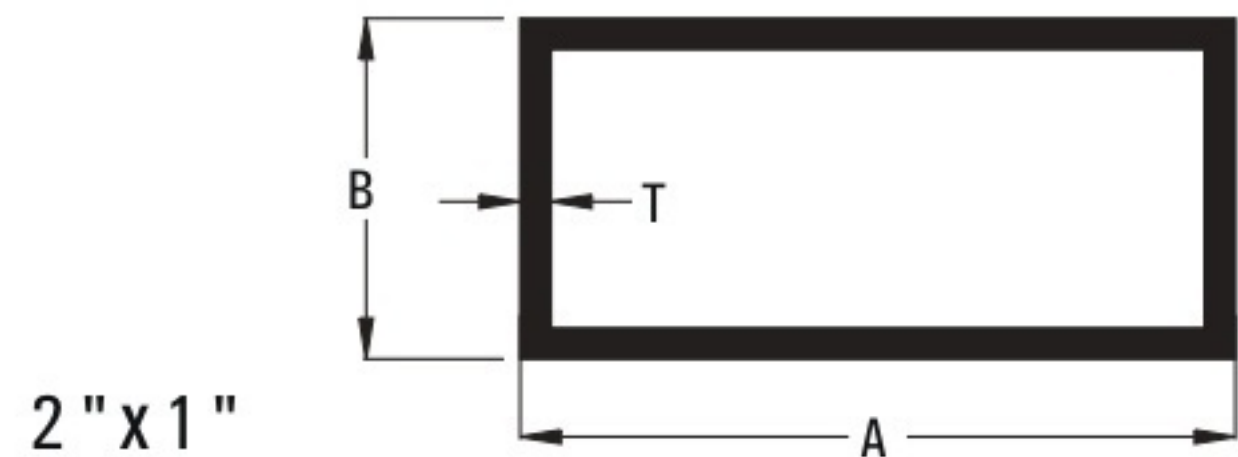

Sr. No	Section No.	A (mm)	B (mm)	T (mm)	Weight(Kg./Mtr)	Weight(Kg./12')
1	1987	50.8	25.4	0.65	0.260	0.95-1.00
2	1988	50.8	25.4	0.85	0.328	1.20-1.40
3	1989	50.8	25.4	1.00	0.383	1.40-1.60
4	1990	50.8	25.4	1.10	0.437	1.60-1.80
5	1991	50.8	25.4	1.25	0.492	1.80-2.00
6	1992	50.8	25.4	1.40	0.547	2.00-2.20

Rectangular Tube

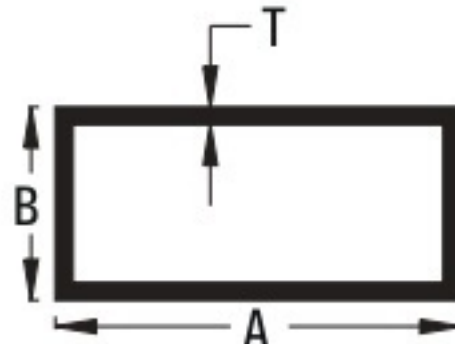

Sr. No	Section No.	A (mm)	B (mm)	T (mm)	Weight(Kg./Mtr)	Weight(Kg./12')
1	2037	100.00	18.0	1.50	0.925	3.400-3.800
2	2038	75.00	18.0	1.50	0.725	2.670-3.070
3	2105	75.00	12.00	1.60	0.137	0.50-0.70
4	2120	101.6	50.8	1.80	1.440	5.300-5.600

Rectangular Tube

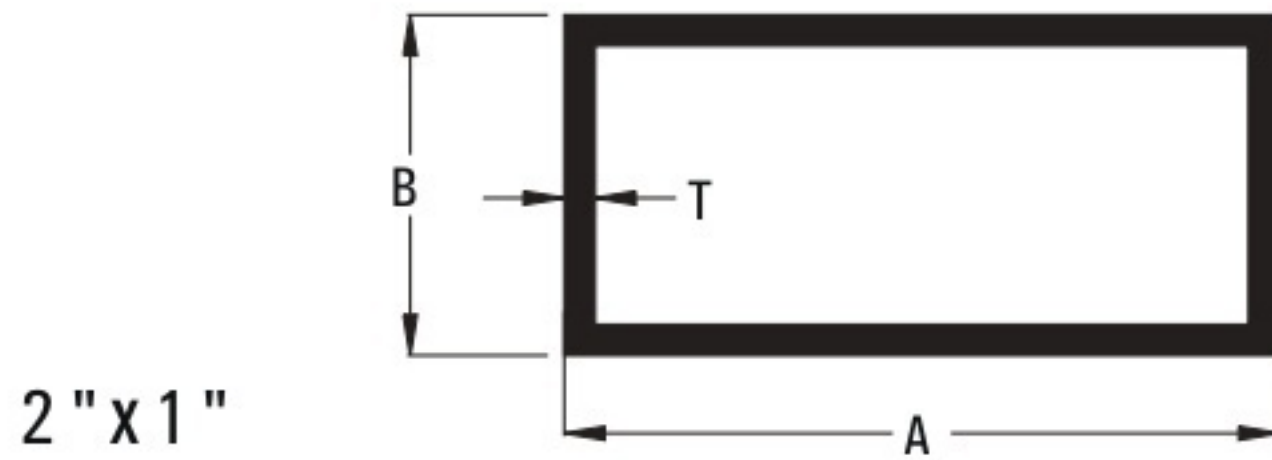

Sr. No	Section No.	A (mm)	B (mm)	T (mm)	Weight(Kg./Mtr)	Weight(Kg./12')
1	1993	50.8	25.4	1.70	0.656	2.40-2.60
2	1994	50.8	25.4	2.15	0.820	3.00-3.20
3	1995	50.8	25.4	2.90	1.093	4.00-4.20

Rectangular Tube

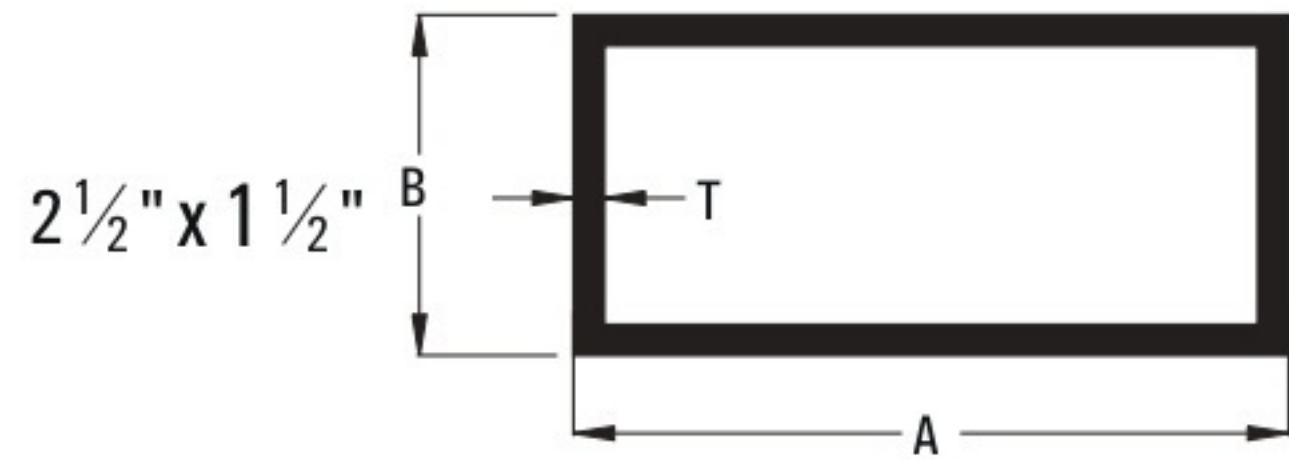

Sr. No	Section No.	A (mm)	B (mm)	T (mm)	Weight(Kg./Mtr)	Weight(Kg./12')
1	2021	63.50	38.10	0.70	0.382	1.40-1.60
2	2022	63.50	38.10	0.80	0.437	1.60-1.80
3	2023	63.50	38.10	0.95	0.492	1.80-2.00
4	2024	63.50	38.10	1.05	0.546	2.00-2.20
5	2025	63.50	38.10	1.15	0.601	2.20-2.40
6	2026	63.50	38.10	1.25	0.656	2.40-2.60
7	2027	63.50	38.10	1.35	0.710	2.60-2.80
8	2028	63.50	38.10	1.45	0.765	2.80-3.00

2 1/2" x 1"

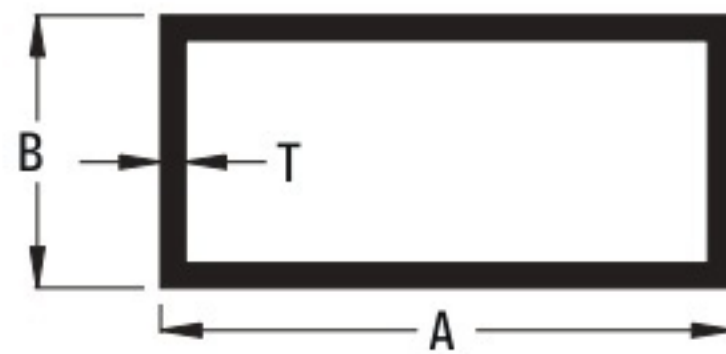

Sr. No	Section No.	A (mm)	B (mm)	T (mm)	Weight(Kg./Mtr)	Weight(Kg./12')
1	2006	63.50	25.40	0.75	0.355	1.30-1.50
2	2007	63.50	25.40	0.90	0.410	1.50-1.70
3	2008	63.50	25.40	1.05	0.492	1.80-2.00
4	2009	63.50	25.40	1.20	0.546	2.00-2.40
5	2010	63.50	25.40	1.45	0.656	2.40-2.60
6	2011	63.50	25.40	1.70	0.765	2.80-3.00

3 1/4" x 1 1/2"

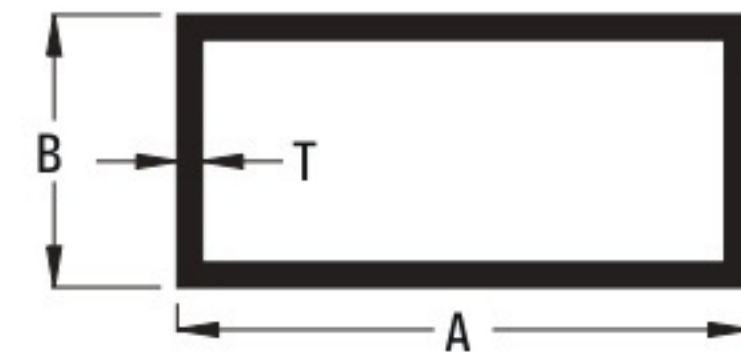

Sr. No	Section No.	A (mm)	B (mm)	T (mm)	Weight(Kg./Mtr)	Weight(Kg./12')
1	2046LL	82.55	38.10	0.85	0.546	2.00-2.200
2	2046L	82.55	38.10	1.05	0.656	2.40-2.60
3	2046M	82.55	38.10	1.15	0.765	2.60-2.80
4	2046MH	82.55	38.10	1.50	0.929	3.40-3.60
5	2046H	82.55	38.10	1.75	1.093	4.00-4.20

3" x 1"

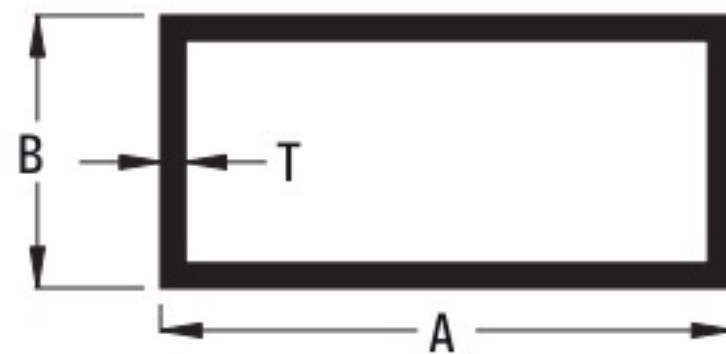

Sr. No	Section No.	A (mm)	B (mm)	T (mm)	Weight(Kg./Mtr)	Weight(Kg./12')
1	2013	76.20	25.40	0.80	0.410	1.50-1.70
2	2014	76.20	25.40	0.95	0.492	1.80-2.00
3	2015	76.20	25.40	1.05	0.546	2.00-2.20
4	2016	76.20	25.40	1.15	0.601	2.20-2.40
5	2017	76.20	25.40	1.25	0.656	2.40-2.60
6	2018	76.20	25.40	1.35	0.710	2.60-2.80

4" x 1"

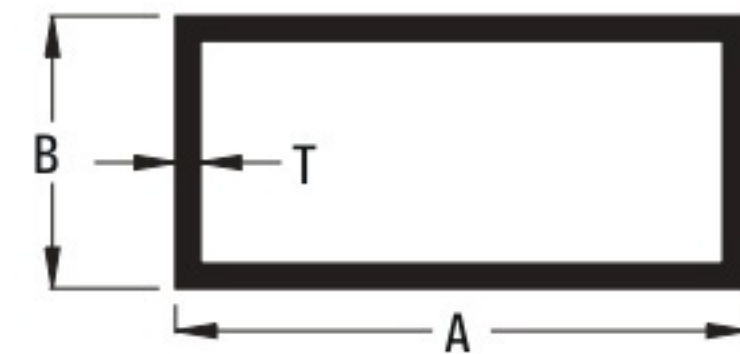

Sr. No	Section No.	A (mm)	B (mm)	T (mm)	Weight(Kg./Mtr)	Weight(Kg./12')
1	2031	101.60	25.40	0.75	0.492	1.80-2.00
2	2032	101.60	25.40	0.80	0.546	2.00-2.20
3	2033	101.60	25.40	0.90	0.601	2.20-2.40
4	2034	101.60	25.40	1.00	0.656	2.40-2.60
5	2035	101.60	25.40	1.05	0.710	2.60-2.80
6	2036	101.60	25.40	1.15	0.765	2.80-3.00

Rectangular Tube

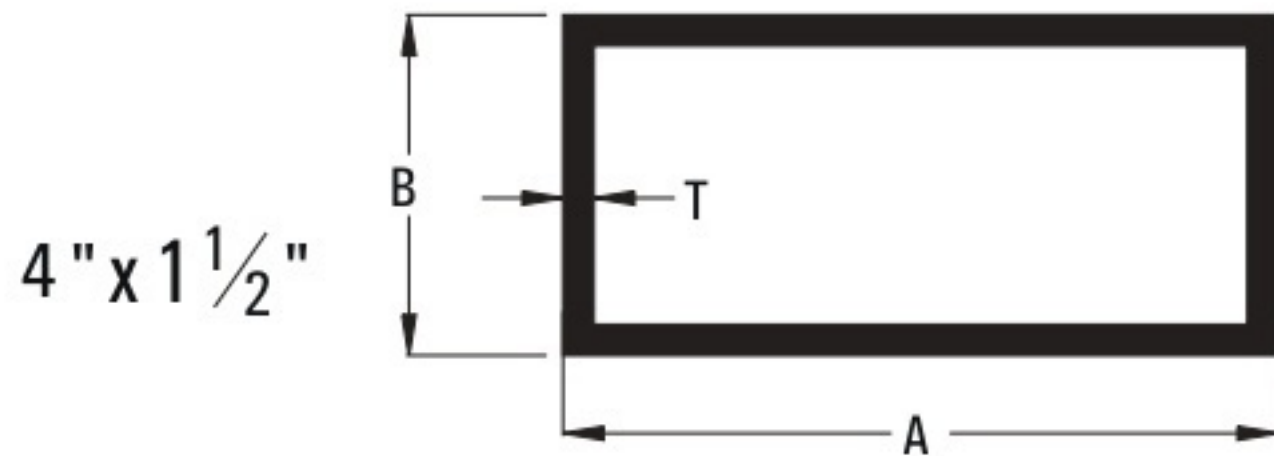

Sr. No	Section No.	A (mm)	B (mm)	T (mm)	Weight(Kg./Mtr)	Weight(Kg./12')
1	2050	101.60	38.10	1.10	0.820	3.00-3.20
2	2049	101.60	38.10	1.25	0.929	3.40-3.60
3	2047	101.60	38.10	1.45	1.039	3.80-4.20
4	2051	101.60	38.10	1.65	1.203	4.40-4.70
5	2052	101.60	38.10	1.80	1.285	4.70-5.00

Rectangular Tube

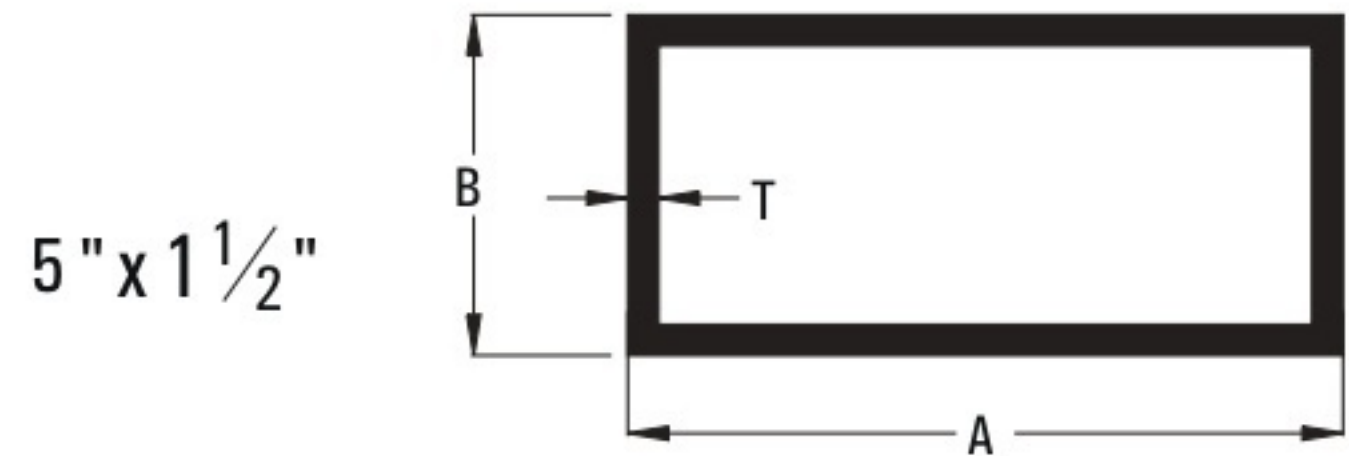

Sr. No	Section No.	A (mm)	B (mm)	T (mm)	Weight(Kg./Mtr)	Weight(Kg./12')
1	2053	127.00	38.10	1.5	1.312	4.8-5.0
2	2054	127.00	38.10	3.05	2.597	9.5-9.8

5 " x 2 "

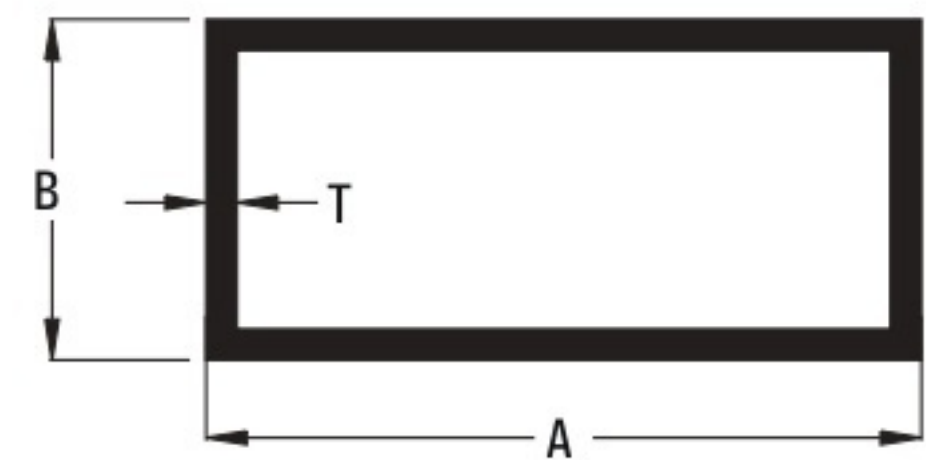

Sr. No	Section No.	A (mm)	B (mm)	T (mm)	Weight(Kg./Mtr)	Weight(Kg./12')
1	2060	127.00	50.00	2.05	1.914	7.0-7.3

4 " x 1 3/4 "

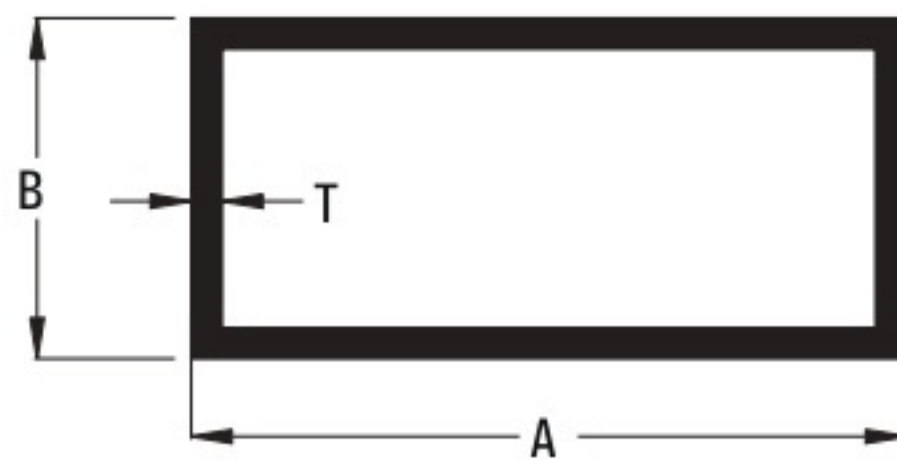

Sr. No	Section No.	A (mm)	B (mm)	T (mm)	Weight(Kg./Mtr)	Weight(Kg./12')
1	2043	101.60	44.45	1.30	1.011	3.70-3.90
2	2044	101.60	44.45	1.40	1.094	4.00-4.20
3	2045	101.60	44.45	1.55	1.203	4.40-4.60

6 " x 1 "

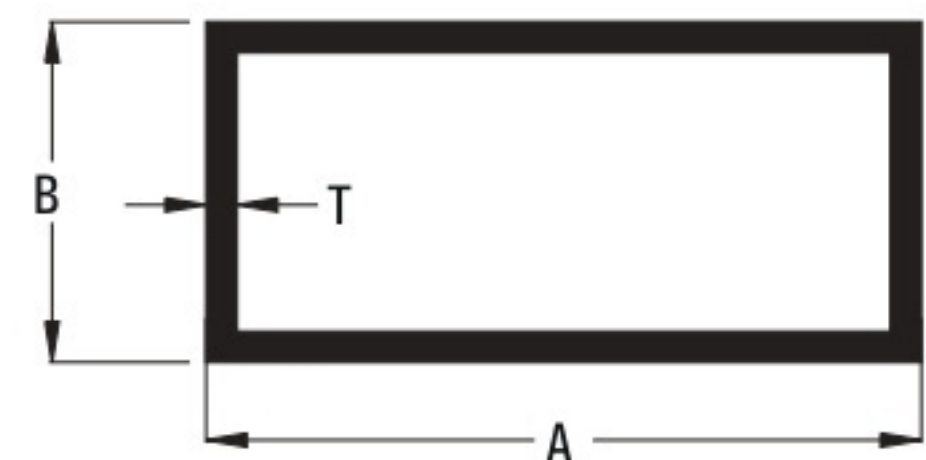

Sr. No	Section No.	A (mm)	B (mm)	T (mm)	Weight(Kg./Mtr)	Weight(Kg./12')
1	2103	152.40	25.40	1.7	1.586	5.800-6.100

5 " x 1 "

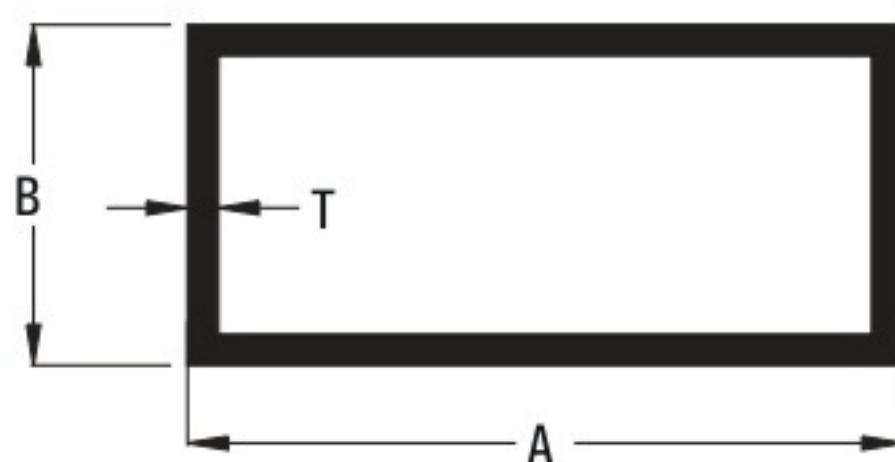

Sr. No	Section No.	A (mm)	B (mm)	T (mm)	Weight(Kg./Mtr)	Weight(Kg./12')
1	2039	127.00	25.40	0.95	0.765	2.80-3.00
2	2040	127.00	25.40	1.05	0.820	3.00-3.20
3	2041	127.00	25.40	1.10	0.875	3.20-3.40
4	2042	127.00	25.40	1.15	0.929	3.40-3.60

6 " x 1 1/2 "

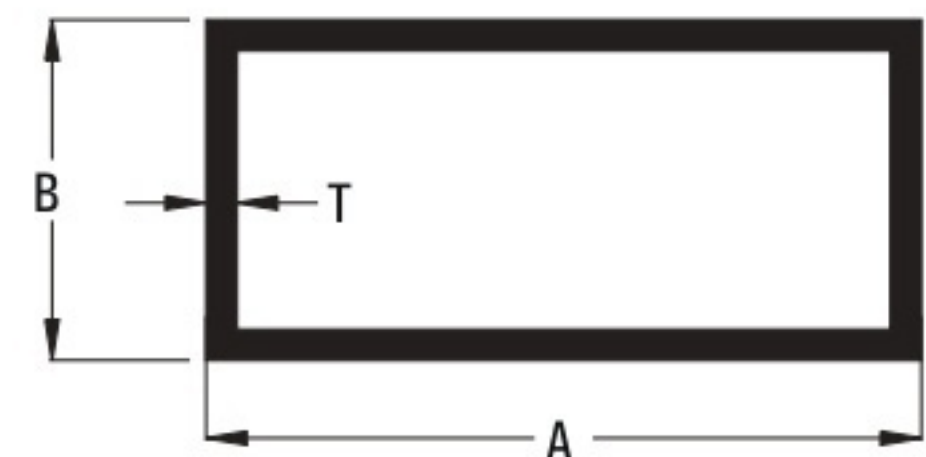

Sr. No	Section No.	A (mm)	B (mm)	T (mm)	Weight(Kg./Mtr)	Weight(Kg./12')
1	2108	150.00	38.10	1.30	1.312	4.8-5.0

Rectangular Tube

6" x 2"

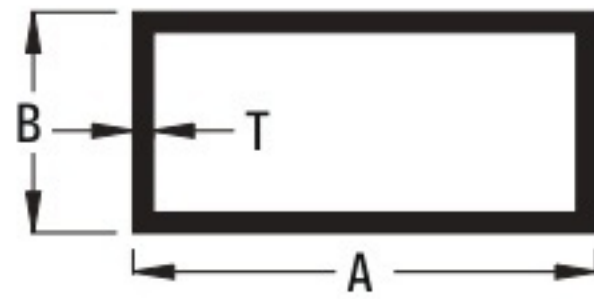

Sr. No	Section No.	A (mm)	B (mm)	T (mm)	Weight(Kg./Mtr)	Weight(Kg./12')
1	2104	150.00	50.0	2.70	2.843	10.4-11.0

Sin-Tex 'A'

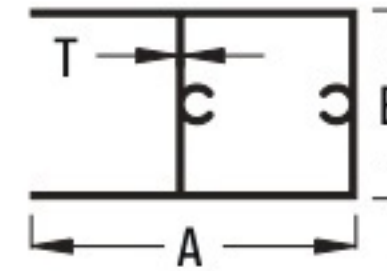

Sr. No	Section No.	A (mm)	B (mm)	T (mm)	Weight(Kg./Mtr)	Weight(Kg./12')
1	2387	40.00	23.20	0.70	0.246	0.90-1.10
2	2388	40.00	23.60	0.90	0.328	1.20-1.40
3	2389	40.00	23.60	1.05	0.383	1.40-1.60

'L' Tube

1 1/2" x 1"

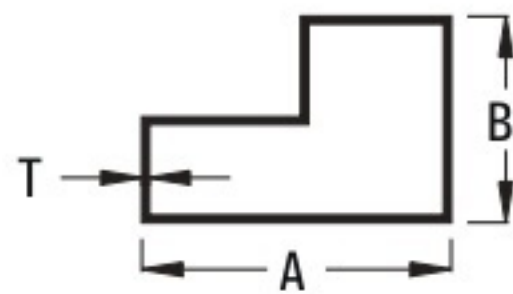

Sr. No	Section No.	A (mm)	B (mm)	T (mm)	Weight(Kg./Mtr)	Weight(Kg./12')
1	2390	38.10	25.40	0.80	0.246	0.90-1.10
2	2391	38.10	25.40	1.00	0.328	1.20-1.40
3	2392	38.10	25.40	1.15	0.383	1.40-1.60

Taper Handle

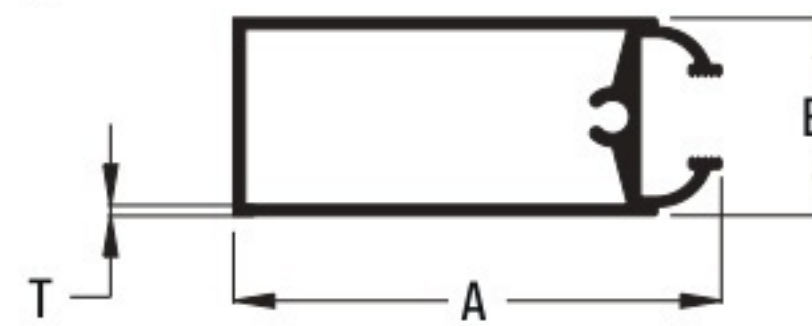

Sr. No	Section No.	A (mm)	B (mm)	T (mm)	Weight(Kg./Mtr)	Weight(Kg./12')
1	2435	60.10	24.30	1.30	0.656	2.400-2.600

'L' Tube

2" x 1"

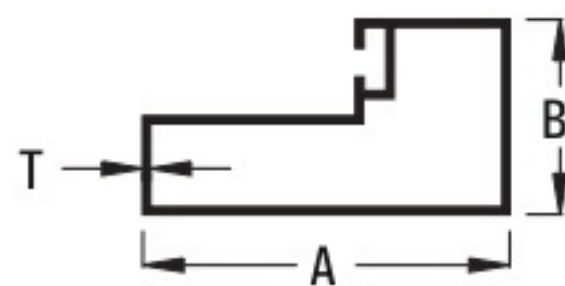

Sr. No	Section No.	A (mm)	B (mm)	T (mm)	Weight(Kg./Mtr)	Weight(Kg./12')
1	2393	50.80	25.40	0.80	0.328	1.20-1.40
2	2394	50.80	25.40	0.90	0.383	1.40-1.60
3	2395	50.80	25.40	1.00	0.437	1.60-1.80

Taper Meeting

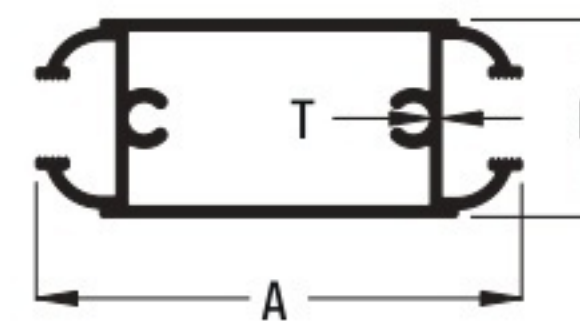

Sr. No	Section No.	A (mm)	B (mm)	T (mm)	Weight(Kg./Mtr)	Weight(Kg./12')
1	2436	60.00	24.30	1.30	0.711	2.60-2.80

Sin-Tex 'H'

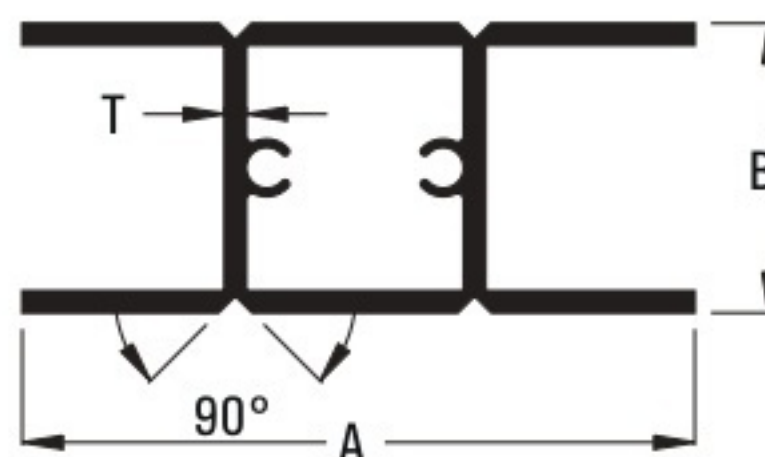

Sr. No	Section No.	A (mm)	B (mm)	T (mm)	Weight(Kg./Mtr)	Weight(Kg./12')
1	2384	60.00	23.60	0.75	0.355	1.30-1.50
2	2385	60.00	23.60	0.92	0.437	1.60-1.80
3	2386	60.00	23.60	1.05	0.492	1.80-2.00

18x50 Handle



Sr. No	Section No.	A (mm)	B (mm)	T (mm)	Weight(Kg./Mtr)	Weight(Kg./12')
1	2440	50.00	18.00	1.15	0.410	1.50-1.70

18x50 Interlock

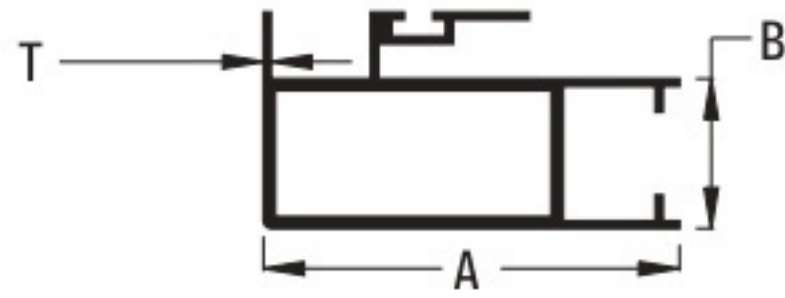

Sr. No	Section No.	A (mm)	B (mm)	T (mm)	Weight(Kg./Mtr)	Weight(Kg./12')
1	2442	50.00	18.00	0.90	0.437	1.60-1.80

18x50 Bearing Bottom

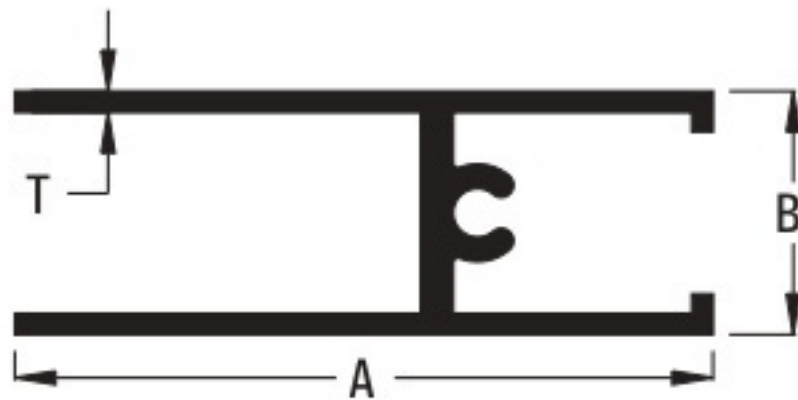

Sr. No	Section No.	A (mm)	B (mm)	T (mm)	Weight(Kg./Mtr)	Weight(Kg./12')
1	2441	43.00	15.00	1.30	0.437	1.40-1.60

Handle

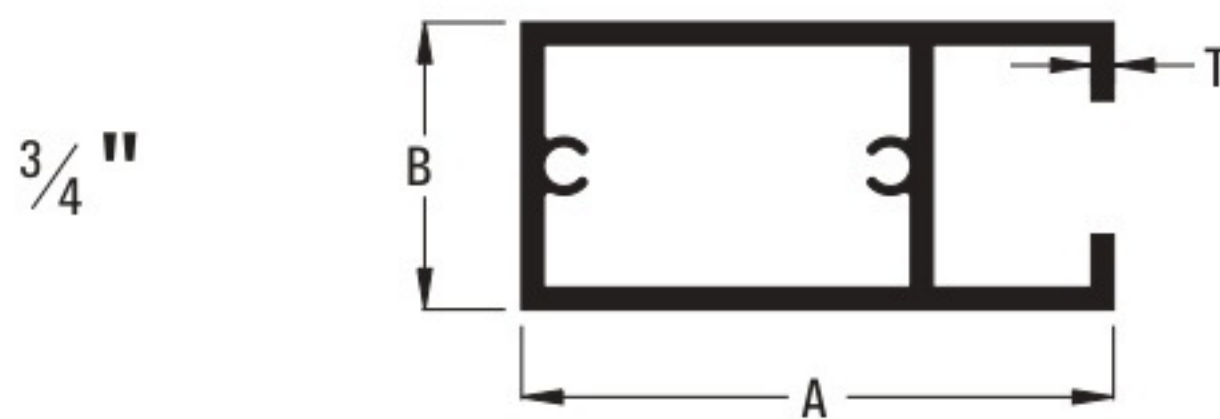

Sr. No	Section No.	A (mm)	B (mm)	T (mm)	Weight(Kg./Mtr)	Weight(Kg./12')
1	2215	40.00	18.00	0.75	0.260	0.95-1.15
2	2216	40.00	18.00	0.91	0.328	1.20-1.40
3	2217	40.00	18.00	1.10	0.383	1.40-1.60
4	2218	40.00	18.00	1.25	0.437	1.60-1.80
5	2219	40.00	18.00	1.40	0.492	1.80-2.00
6	2220	40.00	18.00	1.55	0.547	2.00-2.20
7	2221	40.00	18.00	1.70	0.601	2.20-2.40

Top Bottom

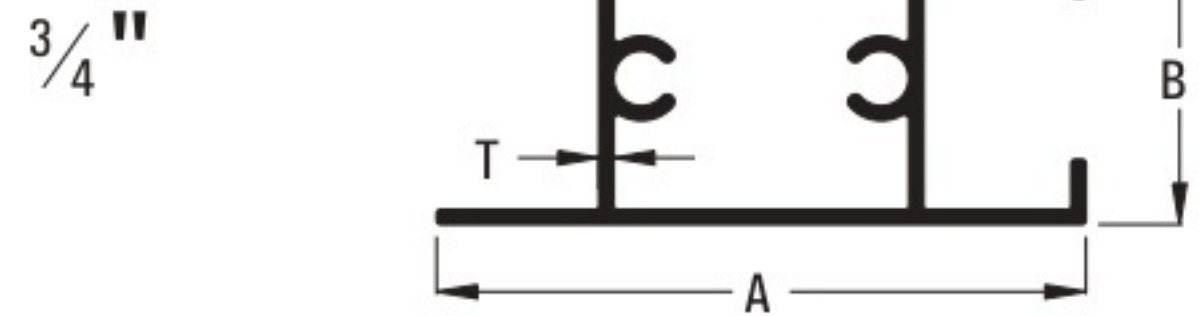

Sr. No	Section No.	A (mm)	B (mm)	T (mm)	Weight(Kg./Mtr)	Weight(Kg./12')
1	2224	40.00	18.00	0.75	0.260	0.95-1.15
2	2225	40.00	18.00	0.91	0.328	1.20-1.40
3	2226	40.00	18.00	1.10	0.383	1.40-1.60
4	2227	40.00	18.00	1.25	0.437	1.60-1.80
5	2228	40.00	18.00	1.40	0.492	1.80-2.00
6	2229	40.00	18.00	1.55	0.547	2.00-2.20
7	2230	40.00	18.00	1.70	0.601	2.20-2.40

Bearing Bottom

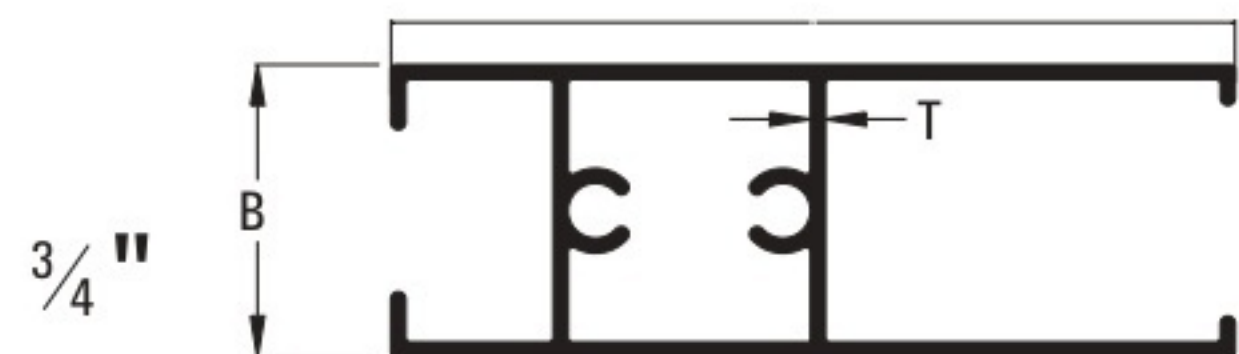

Sr. No	Section No.	A (mm)	B (mm)	T (mm)	Weight(Kg./Mtr)	Weight(Kg./12')
1	2239	52.00	18.00	0.90	0.383	1.40-1.60
2	2240	52.00	18.00	1.05	0.437	1.60-1.80
3	2240H	52.00	18.00	1.30	0.546	2.0-2.20

Meeting

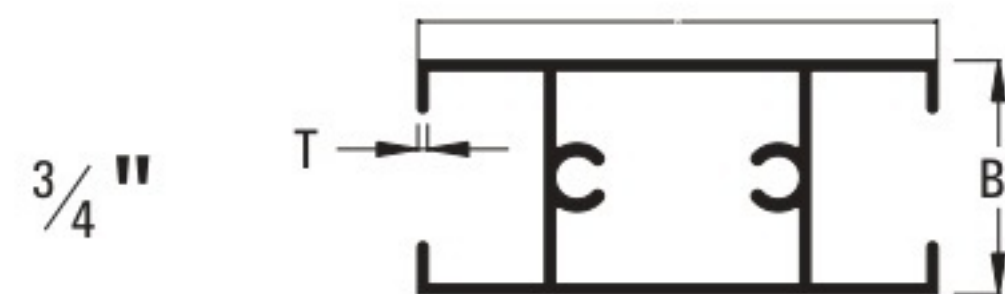

Sr. No	Section No.	A (mm)	B (mm)	T (mm)	Weight(Kg./Mtr)	Weight(Kg./12')
1	2242	40.00	18.00	0.70	0.300	1.10-1.30
2	2241	40.00	18.00	0.80	0.355	1.30-1.50

Interlock

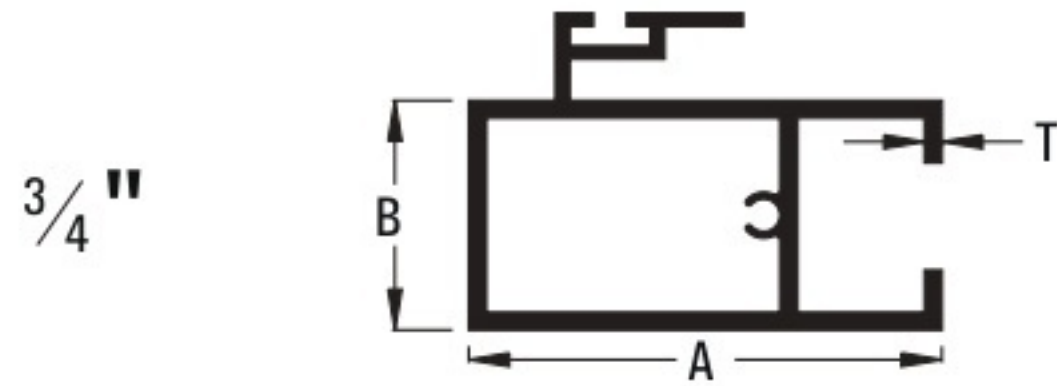

Sr. No	Section No.	A (mm)	B (mm)	T (mm)	Weight(Kg./Mtr)	Weight(Kg./12')
1	2233	40.00	18.00	0.83	0.328	1.20-1.40
2	2234	40.00	18.00	0.91	0.383	1.40-1.60
3	2235	40.00	18.00	1.05	0.437	1.60-1.80
4	2236	40.00	18.00	1.20	0.492	1.80-2.00
5	2237	40.00	18.00	1.45	0.601	2.20-2.40
6	2238	40.00	18.00	1.60	0.656	2.40-2.60

Meeting

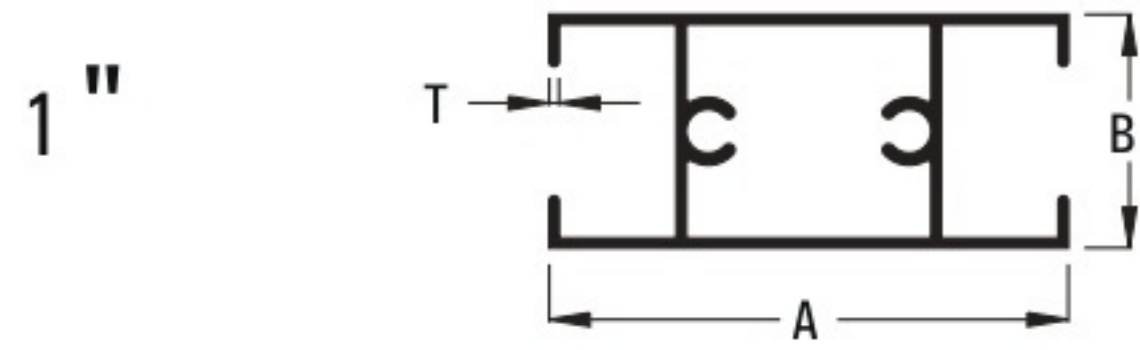

Sr. No	Section No.	A (mm)	B (mm)	T (mm)	Weight(Kg./Mtr)	Weight(Kg./12')
1	2377	50.80	25.40	1.15	0.547	2.00-2.20
2	2378	50.80	25.40	1.25	0.601	2.20-2.40
3	2379	50.80	25.40	0.85	0.437	1.60-1.80
4	2380	50.80	25.40	1.35	0.656	2.40-2.60

Handle

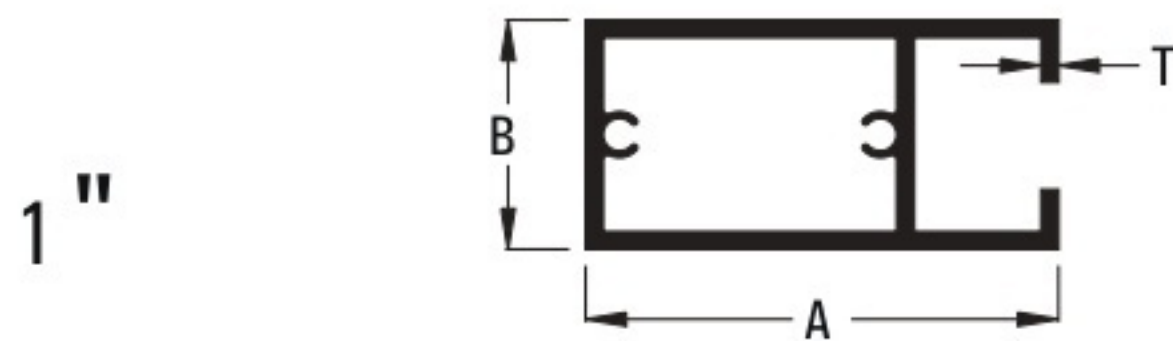

Sr. No	Section No.	A (mm)	B (mm)	T (mm)	Weight(Kg./Mtr)	Weight(Kg./12')
1	2366	50.80	25.40	1.10	0.492	1.80-2.00
2	2367	50.80	25.40	1.20	0.546	2.00-2.20
3	2368	50.80	25.40	1.45	0.656	2.40-2.60
4	2369	50.80	25.40	1.70	0.765	2.80-3.00
5	4025	42.70	25.25	1.20	0.519	1.900-2.200

Bearing Bottom

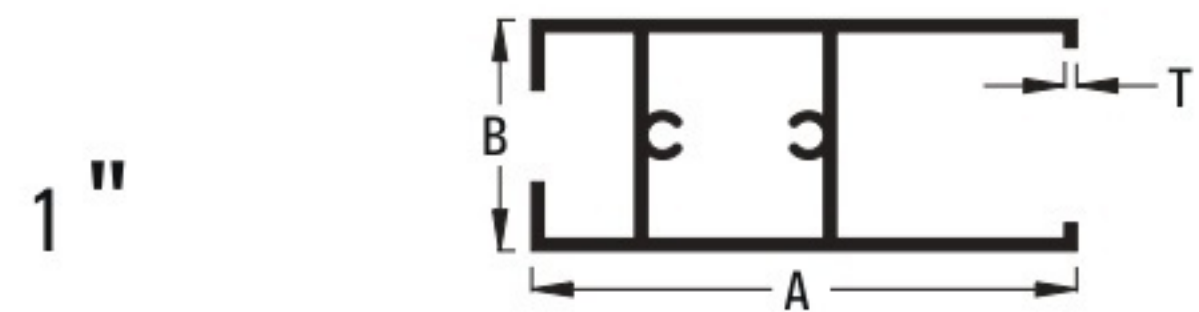

Sr. No	Section No.	A (mm)	B (mm)	T (mm)	Weight(Kg./Mtr)	Weight(Kg./12')
1	2374	60.00	25.40	1.20	0.601	2.20-2.40
2	2375	60.00	25.40	1.30	0.656	2.40-2.60

Interlock

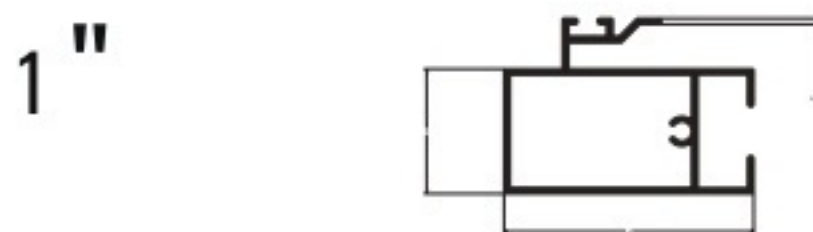

Sr. No	Section No.	A (mm)	B (mm)	T (mm)	Weight(Kg./Mtr)	Weight(Kg./12')
1	2371	50.80	25.40	1.20	0.656	2.40-2.60
2	2372	43.00	25.00	1.10	0.465	1.70-1.90

3'x 1' Handle

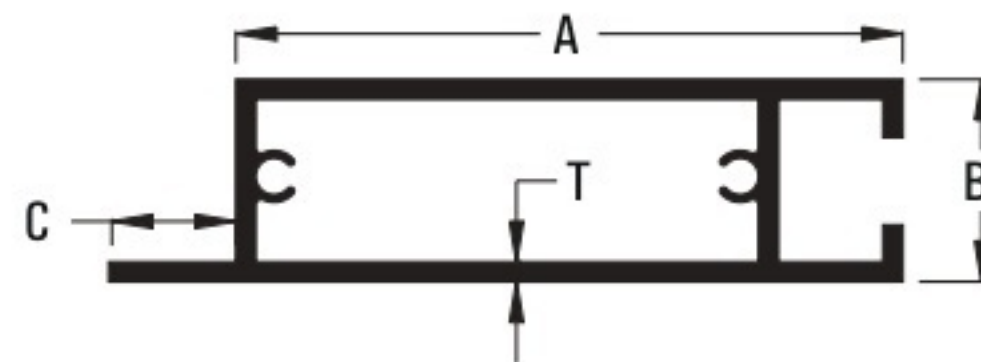

Sr. No	Section No.	A (mm)	B (mm)	C (mm)	T (mm)	Weight(Kg./Mtr)	Weight(Kg./12')
1	2427	72.00	25.40	3.50	1.10	0.656	2.40-2.60

2 Track Top

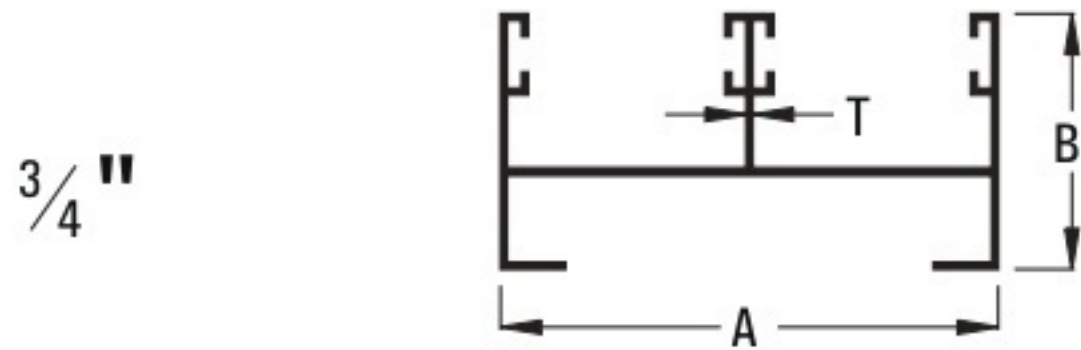

Sr. No	Section No.	A (mm)	B (mm)	T (mm)	Weight(Kg./Mtr)	Weight(Kg./12')
1	2243	61.38	31.50	0.75	0.383	1.40-1.60
2	2244	61.38	31.50	0.85	0.437	1.60-1.80
3	2245	61.38	31.50	1.00	0.492	1.80-2.00
4	2246	61.38	31.50	1.10	0.547	2.00-2.20
5	2247	61.38	31.50	1.20	0.601	2.20-2.40
6	2248	61.38	31.50	1.35	0.656	2.40-2.60
7	2249	61.38	31.50	1.45	0.710	2.60-2.80
8	2250	61.38	31.50	1.55	0.765	2.80-3.00

2 Track Bottom

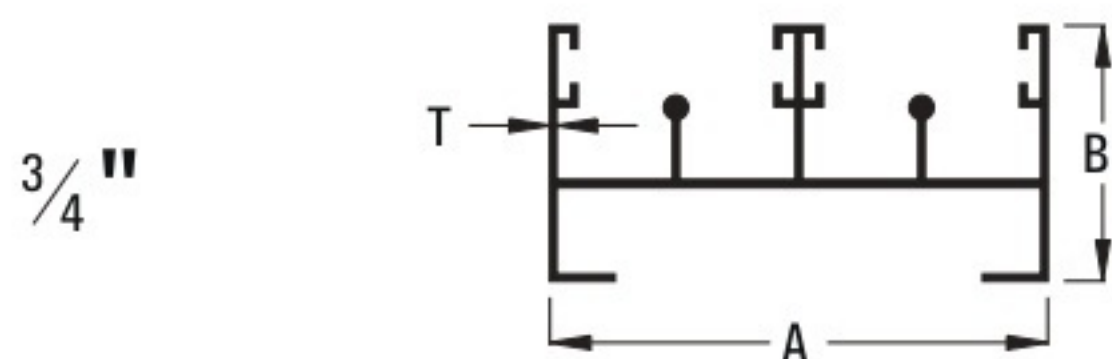

Sr. No	Section No.	A (mm)	B (mm)	T (mm)	Weight(Kg./Mtr)	Weight(Kg./12')
1	2253	61.38	31.50	0.75	0.437	1.60-1.80
2	2254	61.38	31.50	0.85	0.492	1.80-2.00
3	2255	61.38	31.50	0.95	0.547	2.00-2.20
4	2256	61.38	31.50	1.05	0.601	2.20-2.40
5	2257	61.38	31.50	1.15	0.656	2.40-2.60
6	2258	61.38	31.50	1.25	0.711	2.60-2.80
7	2259	61.38	31.50	1.35	0.765	2.80-3.30

3 Track Top

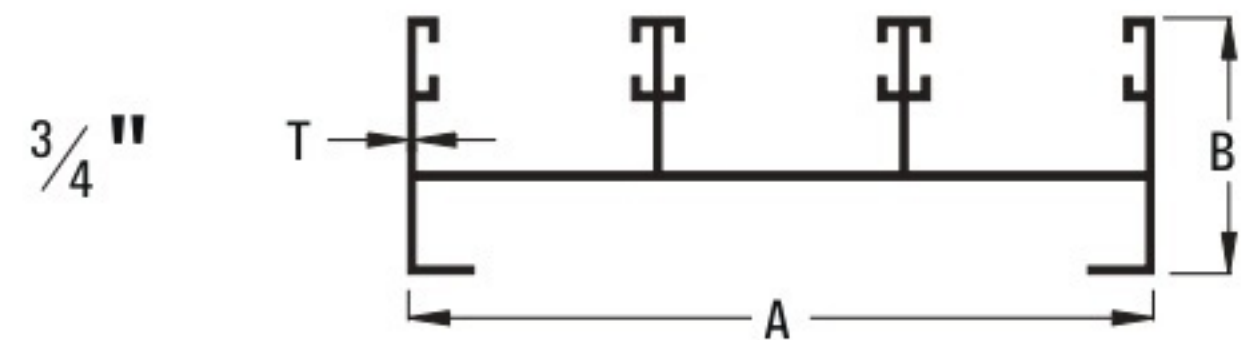

Sr. No	Section No.	A (mm)	B (mm)	T (mm)	Weight(Kg./Mtr)	Weight(Kg./12')
1	2262	91.85	31.50	0.75	0.492	1.80-2.00
2	2263	91.85	31.50	0.85	0.547	2.00-2.20
3	2264	91.85	31.50	1.00	0.656	2.40-2.60
4	2265	91.85	31.50	1.10	0.711	2.60-2.80
5	2266	91.85	31.50	1.15	0.765	2.80-3.00
6	2267	91.85	31.50	1.30	0.875	3.20-3.40
7	2268	91.85	31.50	1.40	0.929	3.40-3.60
8	2269	91.85	31.50	1.60	1.039	3.80-4.00

3 Track Bottom

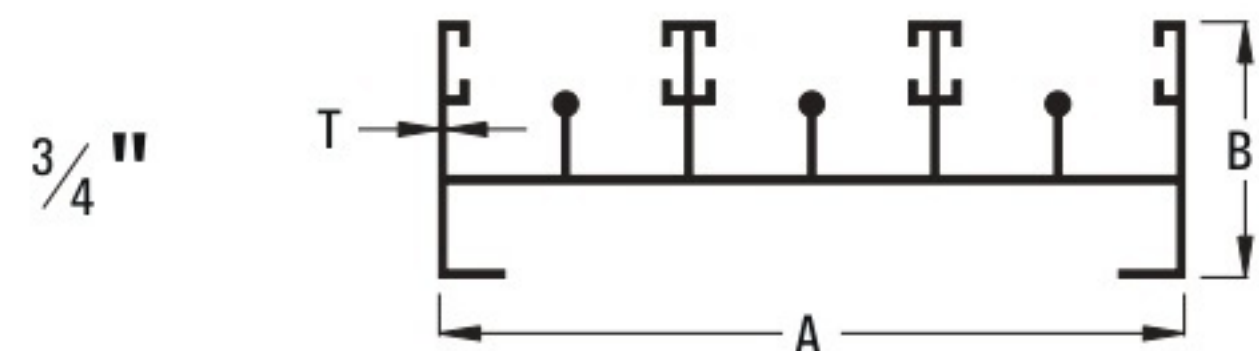

Sr. No	Section No.	A (mm)	B (mm)	T (mm)	Weight(Kg./Mtr)	Weight(Kg./12')
1	2272	91.85	31.50	0.85	0.656	2.40-2.60
2	2273	91.85	31.50	0.90	0.711	2.60-2.80
3	2274	91.85	31.50	1.00	0.765	2.80-3.00
4	2275	91.85	31.50	1.05	0.820	3.00-3.20
5	2276	91.85	31.50	1.15	0.875	3.20-3.40
6	2277	91.85	31.50	1.20	0.929	3.40-3.60
7	2278	91.85	31.50	1.30	0.984	3.60-3.80
8	2279	91.85	31.50	1.35	1.039	3.80-4.00

4 Track Top

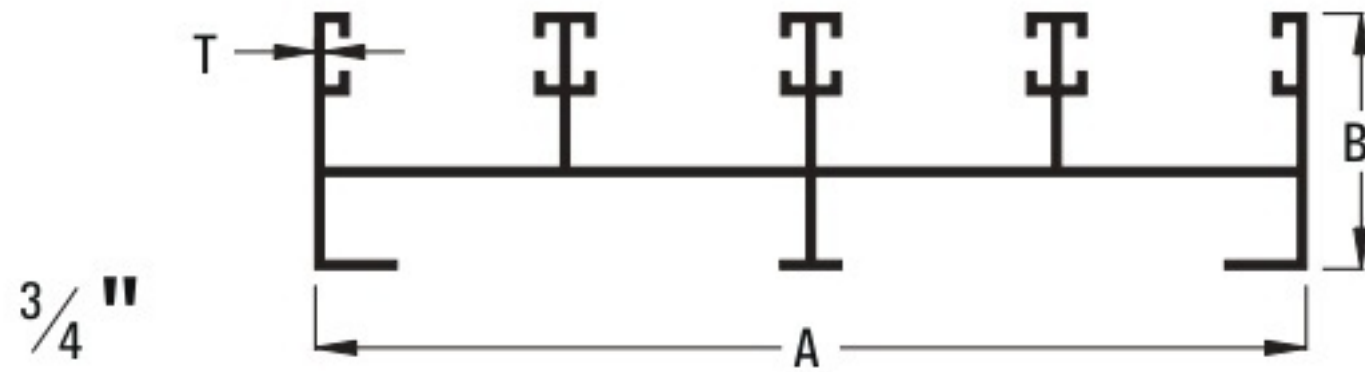

Sr. No	Section No.	A (mm)	B (mm)	T (mm)	Weight(Kg./Mtr)	Weight(Kg./12')
1	2282	122.19	31.50	0.95	0.820	3.00-3.20
2	2283	122.19	31.50	1.00	0.875	3.20-3.40
3	2284	122.19	31.50	1.05	0.929	3.40-3.60
4	2285	122.19	31.50	1.10	0.984	3.60-3.80
5	2286	122.19	31.50	1.20	1.039	3.80-4.00
6	2287	122.19	31.50	1.35	1.203	4.40-4.60
7	2288	122.19	31.50	1.50	1.312	4.80-5.00
8	2289	122.19	31.50	1.75	1.531	5.60-5.80

4 Track Bottom

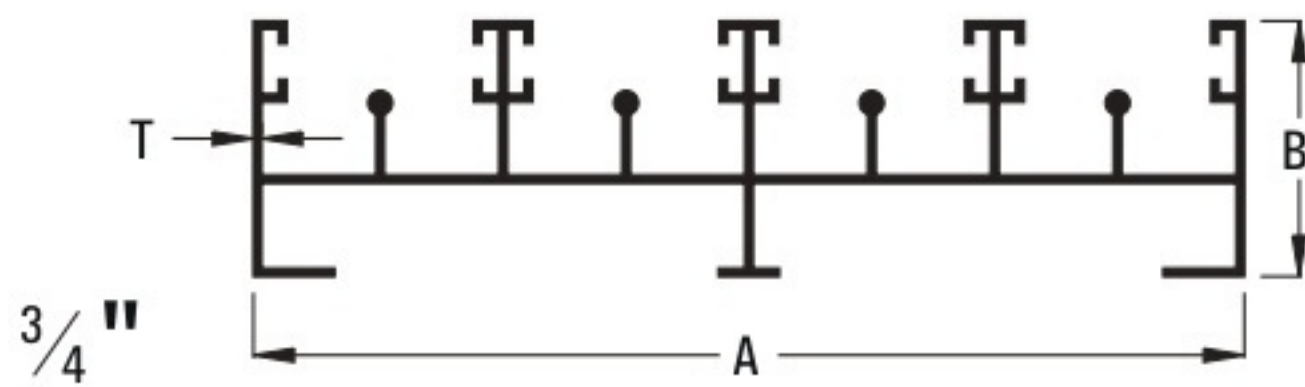

Sr. No	Section No.	A (mm)	B (mm)	T (mm)	Weight(Kg./Mtr)	Weight(Kg./12')
1	2295	122.19	31.50	0.95	1.039	3.80-4.00
2	2296	122.19	31.50	1.00	1.094	4.00-4.20
3	2297	122.19	31.50	1.10	1.203	4.40-4.60
4	2298	122.19	31.50	1.25	1.312	4.80-5.00
5	2299	122.19	31.50	1.50	1.586	5.80-6.00

5 Track Top*

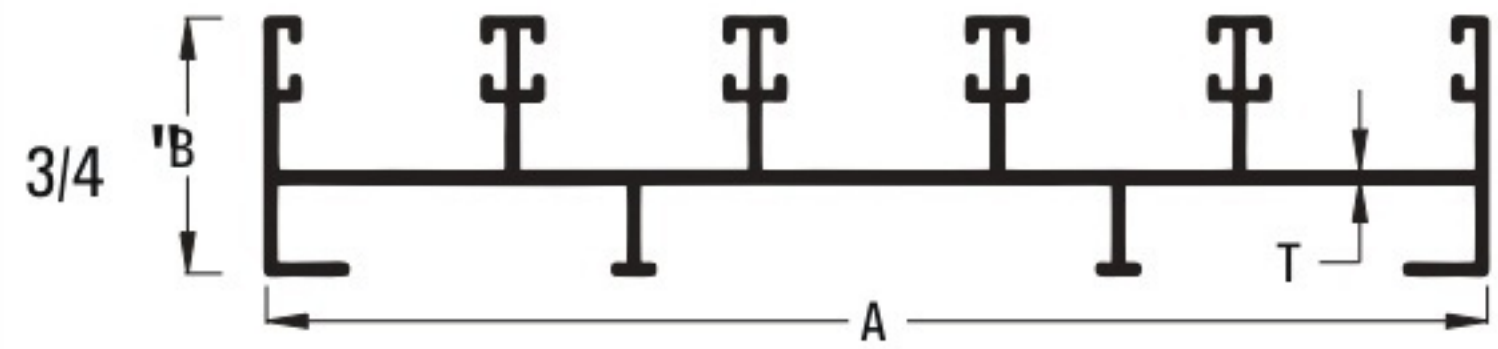

Sr. No	Section No.	A (mm)	B (mm)	T (mm)	Weight(Kg./Mtr)	Weight(Kg./12')
1	3801	150.5	31.50	1.25	1.340	4.90-5.20

5 Track Bottom

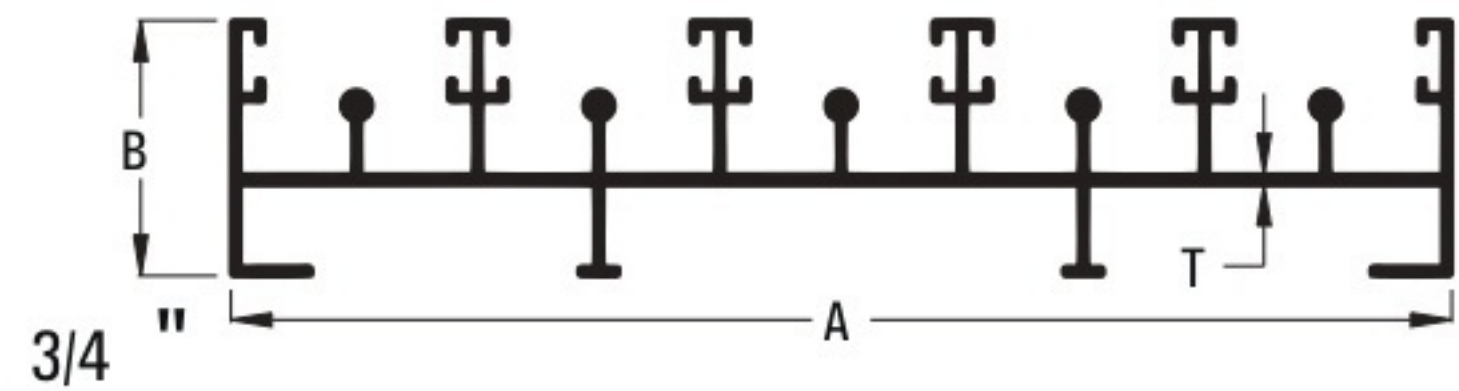

Sr. No	Section No.	A (mm)	B (mm)	T (mm)	Weight(Kg./Mtr)	Weight(Kg./12')
1	3811	150.5	31.50	1.30	1.613	5.90-6.20

2 Track Top

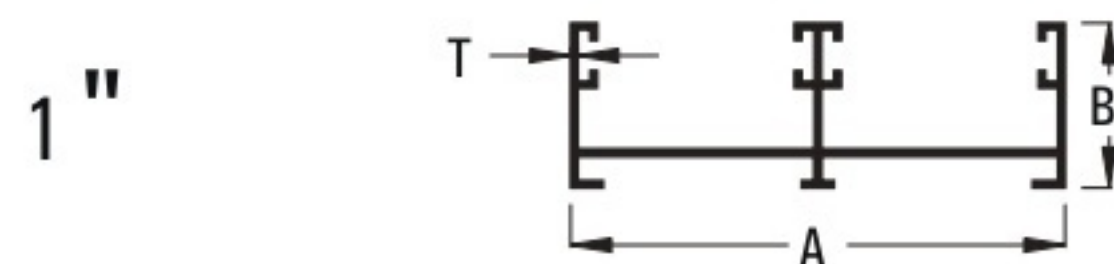

Sr. No	Section No.	A (mm)	B (mm)	T (mm)	Weight(Kg./Mtr)	Weight(Kg./12')
1	2501	76.20	25.40	1.30	0.601	2.20-2.40

2 Track Bottom

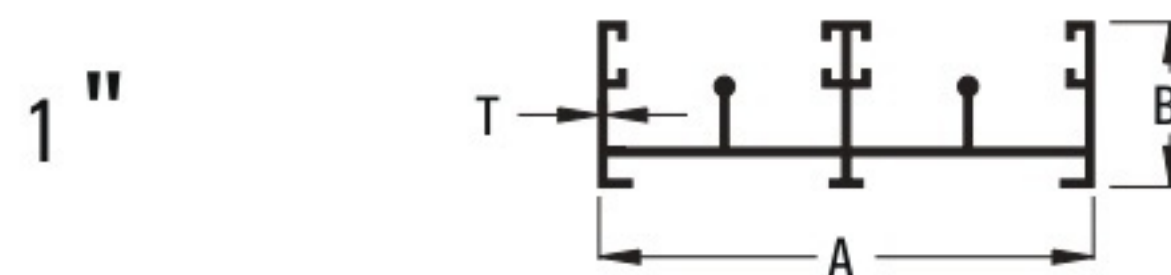

Sr. No	Section No.	A (mm)	B (mm)	T (mm)	Weight(Kg./Mtr)	Weight(Kg./12')
1	2504	76.20	25.40	1.25	0.656	2.40-2.60

3 Track Top

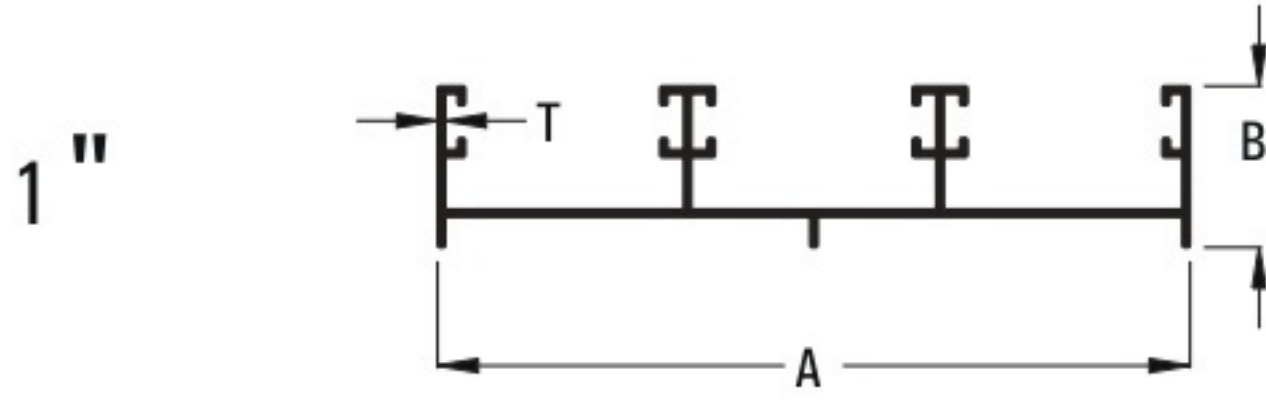

Sr. No	Section No.	A (mm)	B (mm)	T (mm)	Weight(Kg./Mtr)	Weight(Kg./12')
1	2508	116.00	25.00	1.30	0.875	3.20-3.40

3 Track Bottom

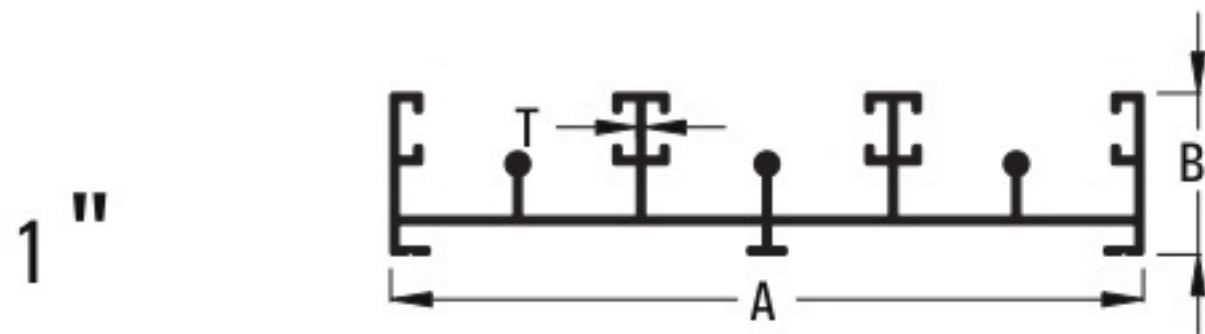

Sr. No	Section No.	A (mm)	B (mm)	T (mm)	Weight(Kg./Mtr)	Weight(Kg./12')
1	2512	116.00	25.00	1.40	0.820	3.90-4.10

4Track Top

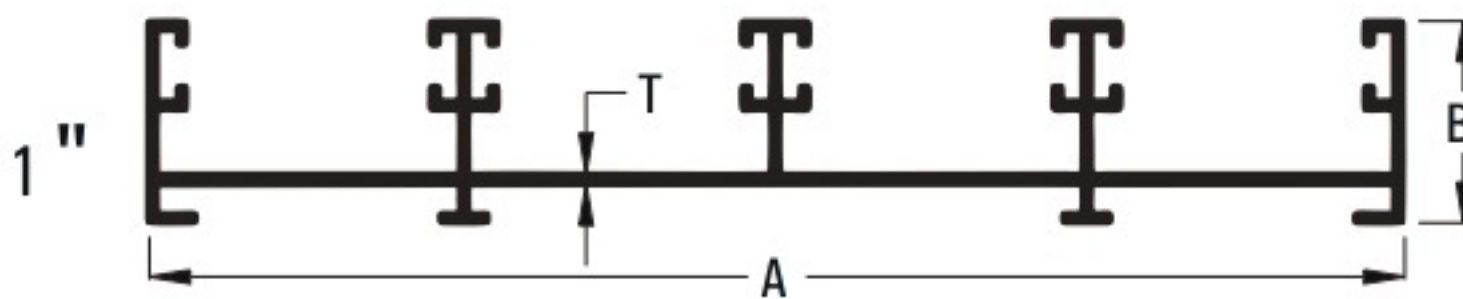

Sr. No	Section No.	A (mm)	B (mm)	T (mm)	Weight(Kg./Mtr)	Weight(Kg./12')
1	2520	154.80	24.90	1.40	1.271	4.650-5.200

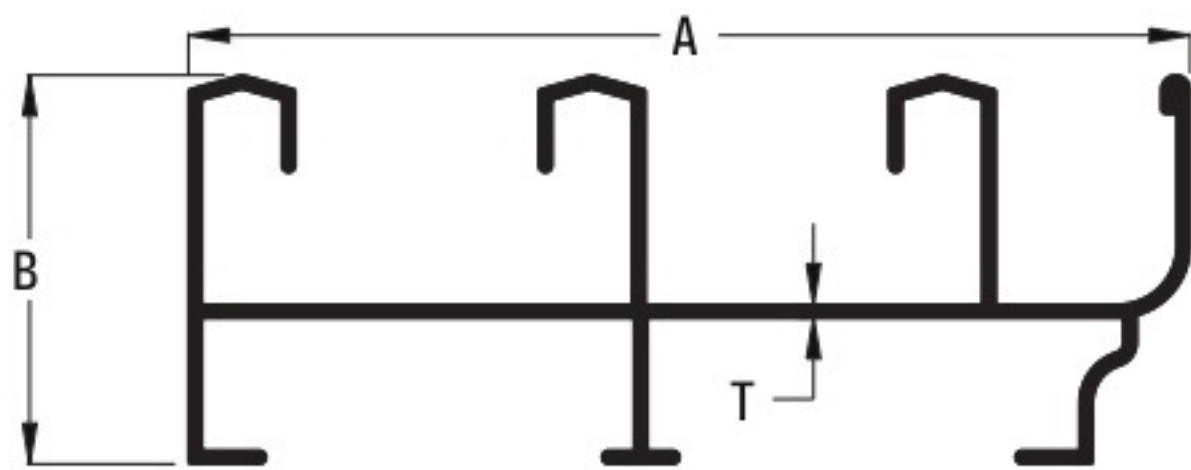

Sr. No	Section No.	A (mm)	B (mm)	T (mm)	Weight(Kg./Mtr)	Weight(Kg./12')
1	6086	93	40	1.4	1.176	4.300-4.500

HOLLOW 3 TRACK BOTTOM

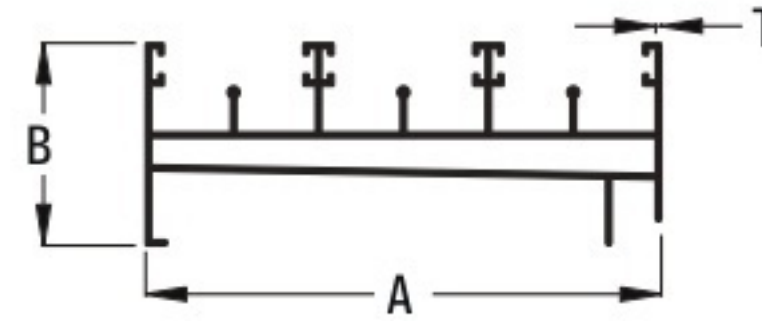

Sr. No	Section No.	A (mm)	B (mm)	T (mm)	Weight(Kg./Mtr)	Weight(Kg./12')
1	4501	45.00	22.40	0.95	1.545	5.650-6.150

HOLLOW 2 TRACK BOTTOM

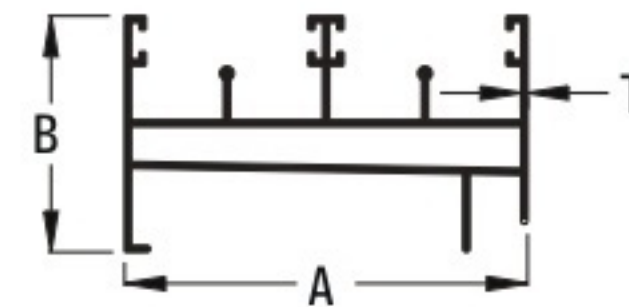

Sr. No	Section No.	A (mm)	B (mm)	T (mm)	Weight(Kg./Mtr)	Weight(Kg./12')
1	4502	38.00	7.50	1.00	1.121	4.100-4.600

Single Partition

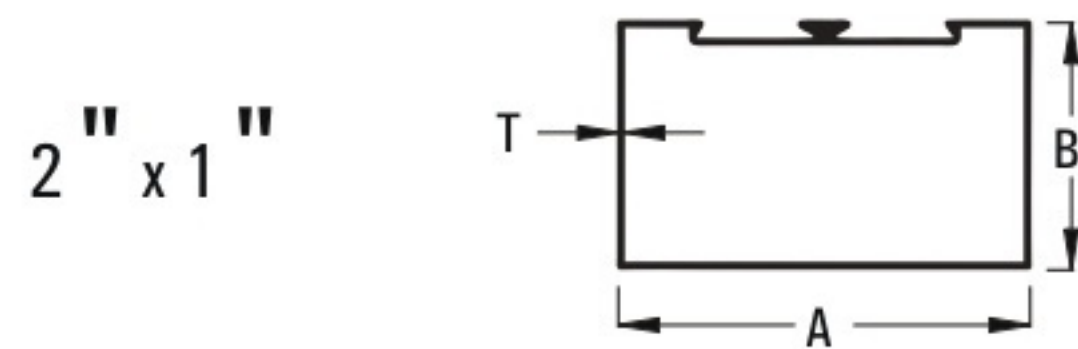

Sr. No	Section No.	A (mm)	B (mm)	T (mm)	Weight(Kg./Mtr)	Weight(Kg./12')
1	2407	50.80	25.40	0.75	0.355	1.30-1.50
2	2409	50.80	25.40	0.95	0.437	1.60-1.80
3	2411	50.80	25.40	1.10	0.492	1.80-2.00

Double Partition

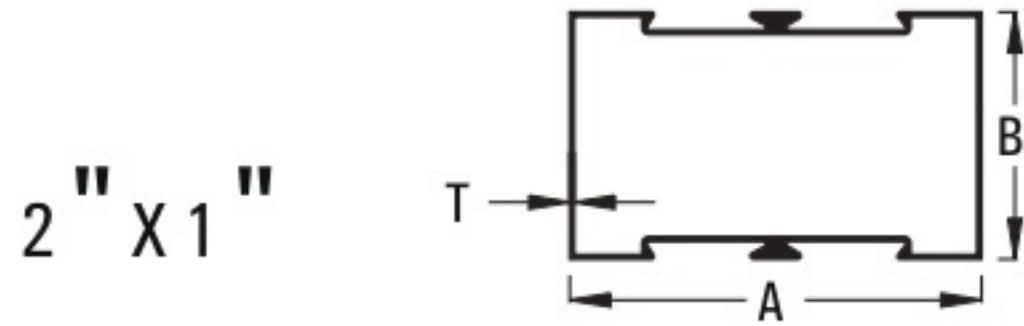

Sr. No	Section No.	A (mm)	B (mm)	T (mm)	Weight(Kg./Mtr)	Weight(Kg./12')
1	2408	50.80	25.40	0.60	0.355	1.30-1.50
2	2410	50.80	25.40	0.80	0.437	1.60-1.80
3	2412	50.80	25.40	0.95	0.492	1.80-2.00

Double Partition

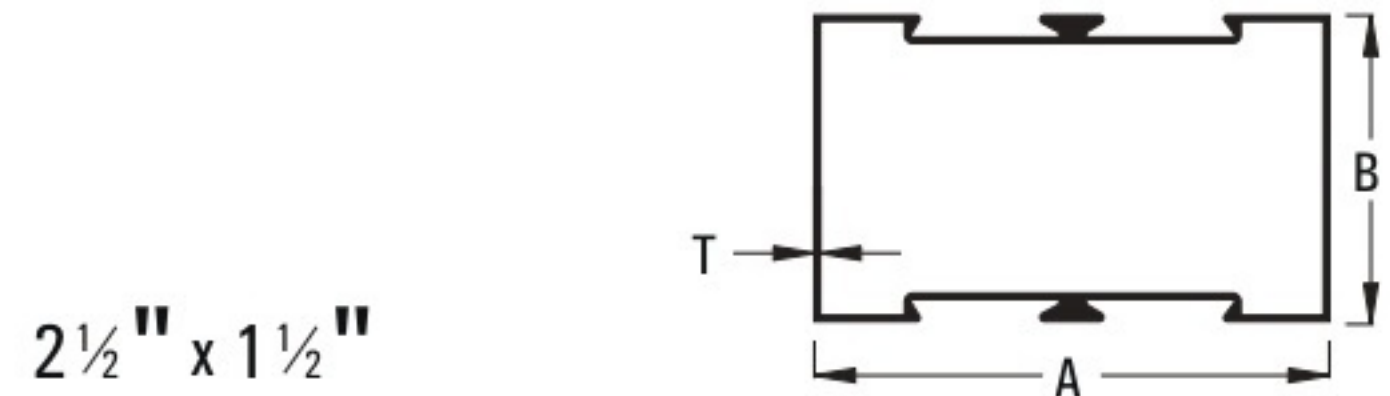

Sr. No	Section No.	A (mm)	B (mm)	T (mm)	Weight(Kg./Mtr)	Weight(Kg./12')
1	2314	63.50	38.10	0.70	0.492	1.80-2.00
2	2315	63.50	38.10	0.90	0.601	2.20-2.40
3	2316	63.50	38.10	1.00	0.656	2.40-2.60

Single Partition

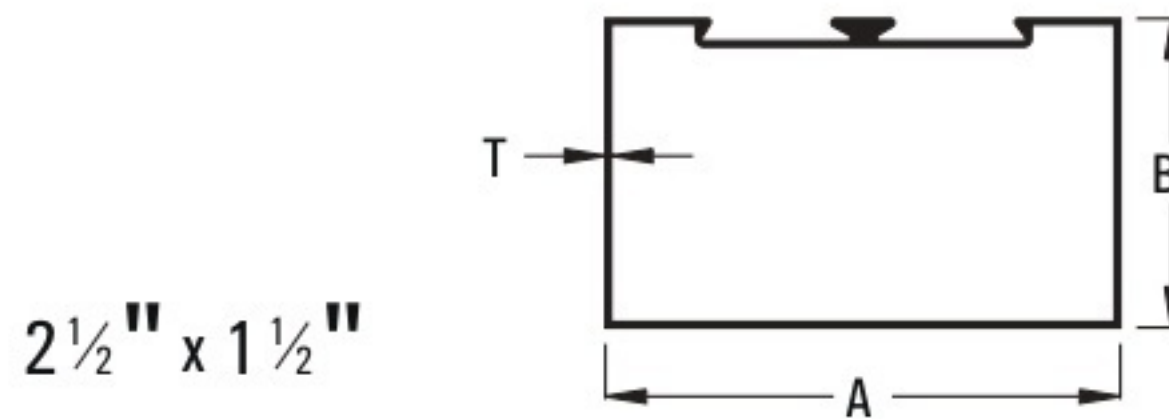

Sr. No	Section No.	A (mm)	B (mm)	T (mm)	Weight(Kg./Mtr)	Weight(Kg./12')
1	2301	63.50	38.10	0.80	0.492	1.80-2.10
2	2302	63.50	38.10	0.90	0.547	2.0-2.40
3	2303	63.50	38.10	1.10	0.656	2.40-2.60
4	2304	63.50	38.10	1.20	0.711	2.60-2.80
5	2305	63.50	38.10	1.35	0.765	2.80-3.00
6	2306	63.50	38.10	1.50	0.875	3.20-3.40
7	2307	63.50	38.10	1.75	0.984	3.60-3.80
8	2308	63.50	38.10	1.85	1.039	3.80-4.00
9	2309	63.50	38.10	2.20	1.203	4.40-4.70
10	2310	63.50	38.10	2.40	1.312	4.80-5.10
11	2311	63.50	38.10	2.80	1.504	5.50-6.00

Double Partition

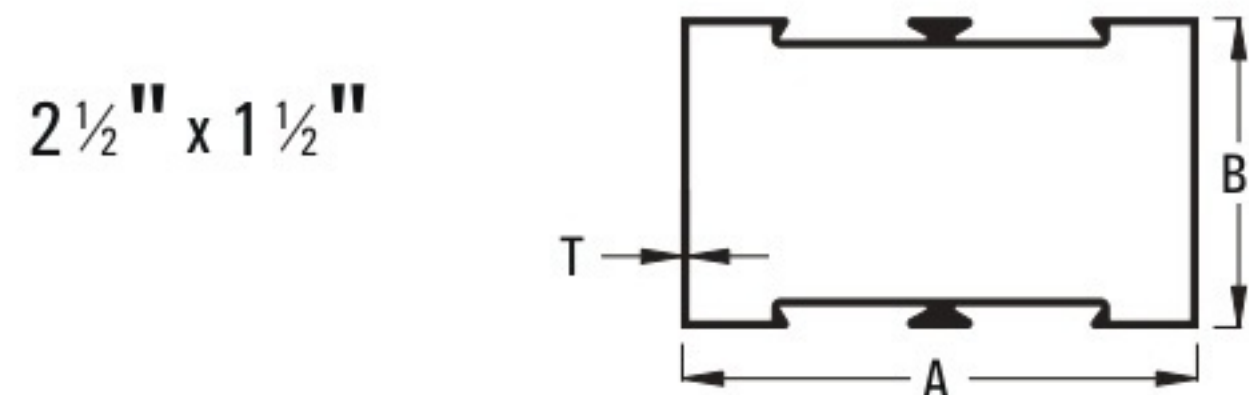

Sr. No	Section No.	A (mm)	B (mm)	T (mm)	Weight(Kg./Mtr)	Weight(Kg./12')
1	2317	63.50	38.10	1.10	0.711	2.60-2.80
2	2318	63.50	38.10	1.20	0.765	2.80-3.00
3	2319	63.50	38.10	1.40	0.875	3.20-3.40
4	2320	63.50	38.10	1.60	0.984	3.60-3.80
5	2321	63.50	38.10	1.70	1.039	3.80-4.00
6	2322	63.50	38.10	2.25	1.312	4.80-5.00
7	2323	63.50	38.10	2.40	1.367	5.00-5.40
8	2324	63.50	38.10	2.65	1.504	5.50-6.00

Single Partition

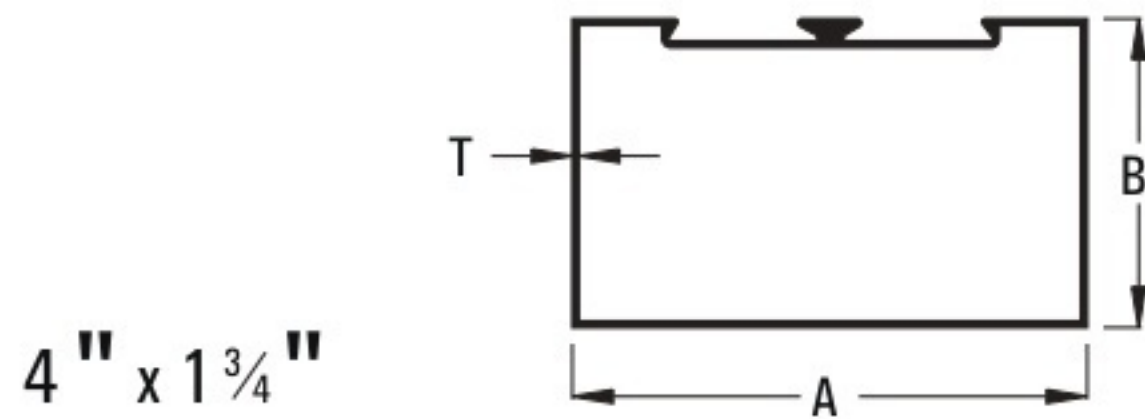

Sr. No	Section No.	A (mm)	B (mm)	T (mm)	Weight(Kg./Mtr)	Weight(Kg./12')
1	2329	101.60	44.45	1.20	0.384	3.60-3.80
2	2330	101.60	44.45	1.25	1.011	3.70-4.00
3	2331	101.60	44.45	1.90	1.504	5.50-5.70
4	2332	101.60	44.45	2.80	2.187	8.0-8.50

Corner Partition (samosa)

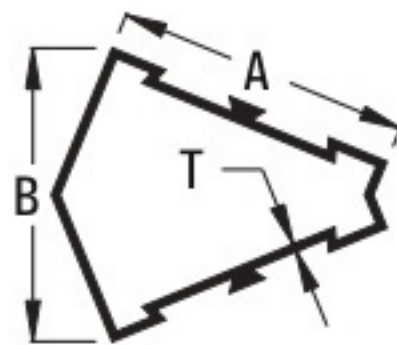

Sr. No	Section No.	A (mm)	B (mm)	T (mm)	Weight(Kg./Mtr)	Weight(Kg./12')
1	2432	63.57	58.00	1.60	0.875	3.20-4.00

Double Partition

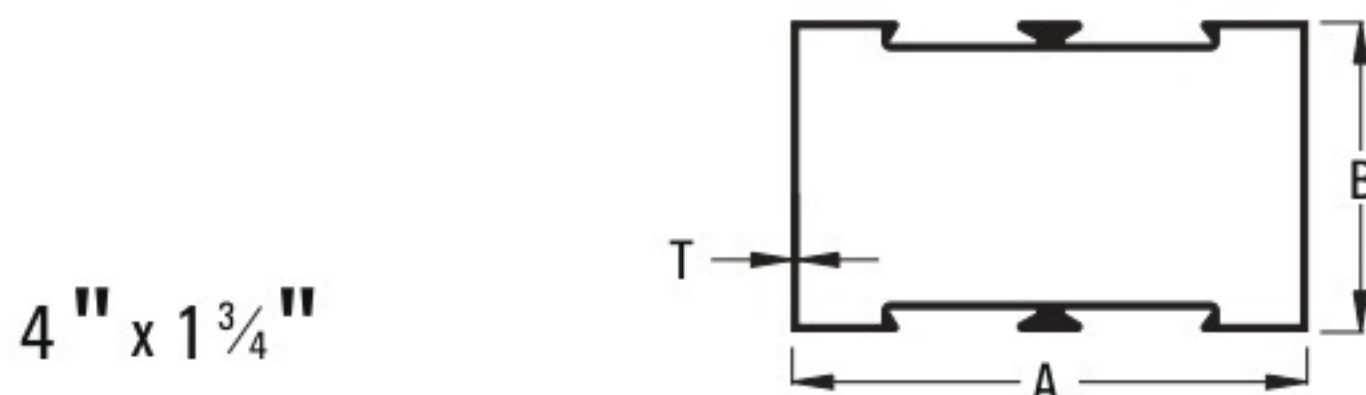

Sr. No	Section No.	A (mm)	B (mm)	T (mm)	Weight(Kg./Mtr)	Weight(Kg./12')
1	2334	101.60	44.45	1.20	0.984	3.60-3.80
2	2335	101.60	44.45	1.25	1.039	3.80-4.00
3	2336	101.60	44.45	1.90	1.504	5.50-5.70
4	2337	101.60	44.45	2.80	2.187	8.0-8.50

Leg Partition

2 1/2" x 1 1/2"

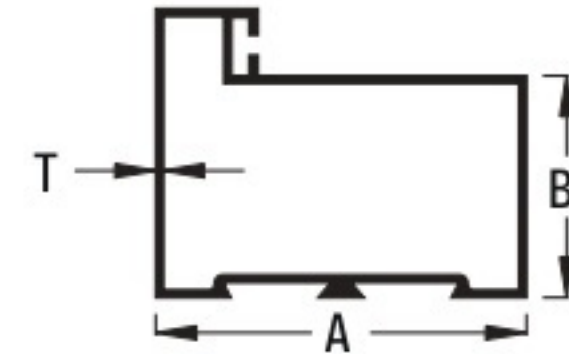

Sr. No	Section No.	A (mm)	B (mm)	T (mm)	Weight(Kg./Mtr)	Weight(Kg./12')
1	2325	63.50	38.10	2.5	1.640	6.0-6.50
2	2326	63.50	38.10	1.30	0.875	3.20-3.40
3	2327	63.50	38.10	1.70	1.094	4.00-4.20

TRIX VERTICAL

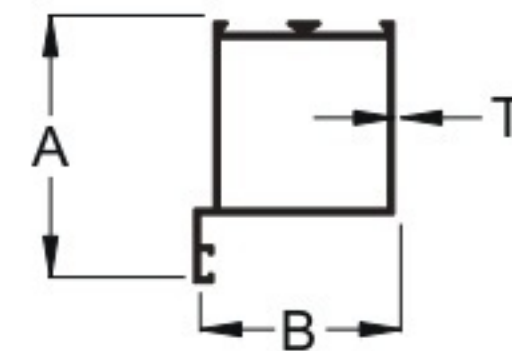

Sr. No	Section No.	A (mm)	B (mm)	T (mm)	Weight(Kg./Mtr)	Weight(Kg./12')
1	2352	64.42	49.3	1.4	0.875	3.200-3.400

Single Leg Door Top

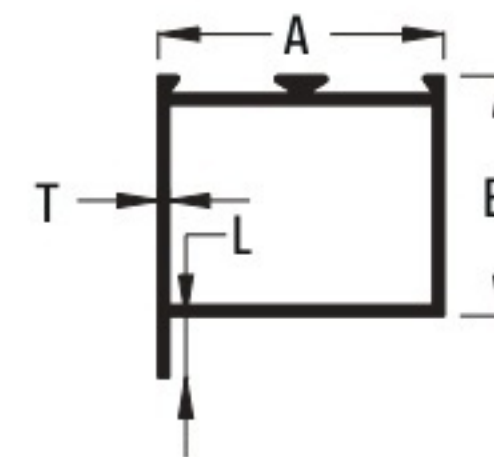

Sr. No	Section No.	A (mm)	B (mm)	L (mm)	T (mm)	Weight(Kg./Mtr)	Weight(Kg./12')
1	2419	44.45	37.00	10.00	1.60	0.765	2.80-3.00

2 1/2"x1" Double Partition

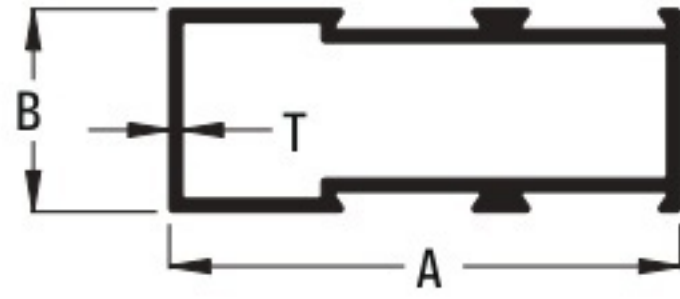

Sr. No	Section No.	A (mm)	B (mm)	T (mm)	Weight(Kg./Mtr)	Weight(Kg./12')
1	2446	63.00	25.00	1.60	0.820	3.00-3.40

Door Vertical

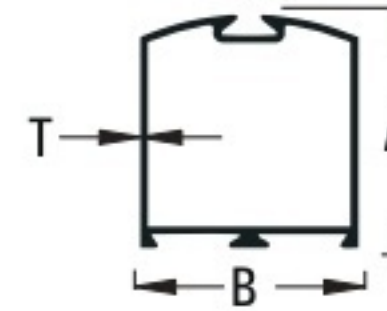

Sr. No	Section No.	A (mm)	B (mm)	T (mm)	Weight(Kg./Mtr)	Weight(Kg./12')
1	2344	48.00	44.50	1.10	0.601	2.20-2.40
2	2345	48.00	44.50	1.40	0.738	2.70-3.00
3	2347	85.00	44.45	1.60	0.820	3.000-3.200
4	2400	85.00	44.45	1.90	1.011	3.70-4.00
5	2401	85.00	44.45	2.25	1.148	4.20-4.500

Door Bottom

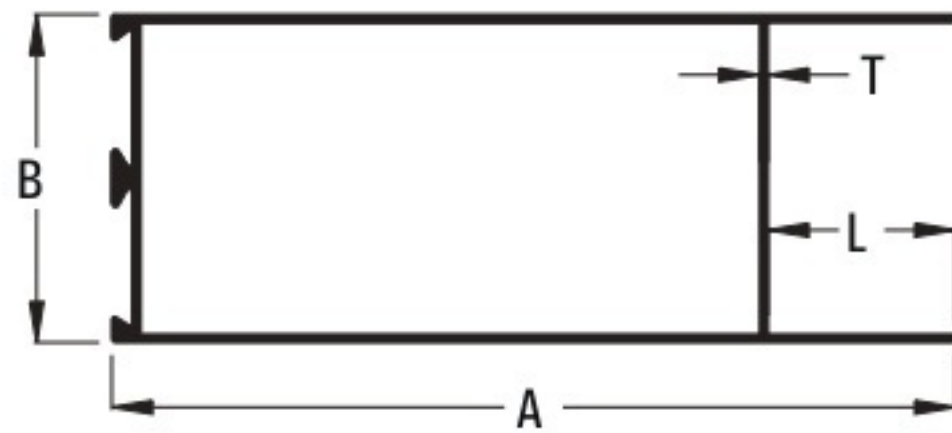

Sr. No	Section No.	A (mm)	B (mm)	L (mm)	T (mm)	Weight(Kg./Mtr)	Weight(Kg./12')
1	2410	114.00	44.45	10.00	1.80	1.531	5.60-5.80
2	2413	114.00	44.45	10.00	1.30	1.148	4.20-4.50
3	2424	85.00	44.50	10.00	1.50	1.312	4.80-5.00
4	2340	114.00	44.50	25.00	1.12	1.011	3.70-4.00

Door Middle Single

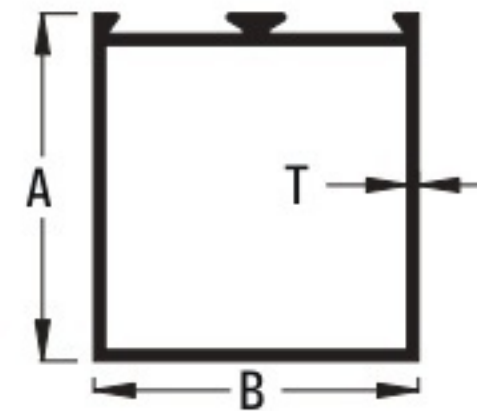

Sr. No	Section No.	A (mm)	B (mm)	T (mm)	Weight(Kg./Mtr)	Weight(Kg./12')
1	2354	48.00	44.50	1.10	0.601	2.20-2.40
2	2355	48.00	44.50	1.35	0.711	2.60-2.80
3	2356	85.00	44.45	1.45	0.765	2.80-3.00
4	2409	85.00	44.45	2.00	1.011	3.70-4.00

Door Top

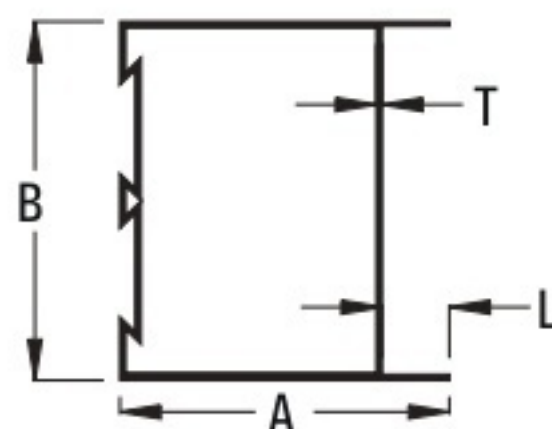

Sr. No	Section No.	A (mm)	B (mm)	L (mm)	T (mm)	Weight(Kg./Mtr)	Weight(Kg./12')
1	2348	48.00	44.50	10.00	1.10	0.601	2.20-2.40
2	2349	48.00	44.50	10.00	1.35	0.711	2.60-2.80
3	2350	48.00	44.50	10.00	1.45	0.765	2.80-3.00
4	2351	48.00	44.50	10.00	1.65	0.875	3.20-3.40

Door Middle Double

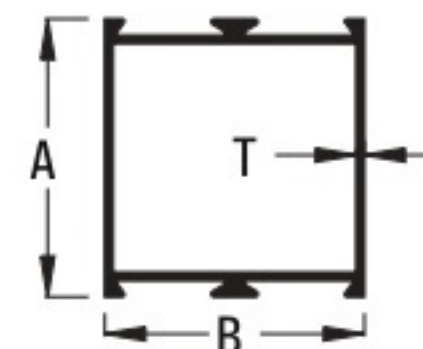

Sr. No	Section No.	A (mm)	B (mm)	T (mm)	Weight(Kg./Mtr)	Weight(Kg./12')
1	2359	48.00	44.45	0.90	0.601	2.20-2.40
2	2360	48.00	44.45	1.15	0.711	2.60-2.80
3	2361	48.00	44.45	1.30	0.765	2.80-3.00
4	2411	85.50	44.50	1.85	1.011	3.70-4.00

Structure Glazing

FROM:-2115-2315

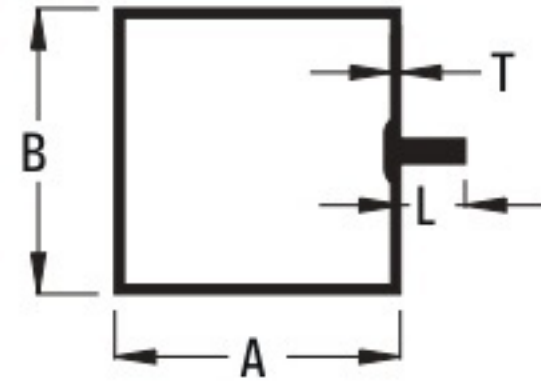

Sr. No	Section No.	A (mm)	B (mm)	L (mm)	T (mm)	Weight(Kg./Mtr)	Weight(Kg./12')
1	2416	80.00	50.00	13.00	1.65	1.176	4.30-4.60
2	2417	50.00	50.00	6.00	1.60	0.547	2.00-2.30
3	2418	44.00	44.00	10.00	1.40	0.738	2.70-3.00
4	2433	64.00	58.00	10.00	1.50	1.066	3.90-4.10

MULLION

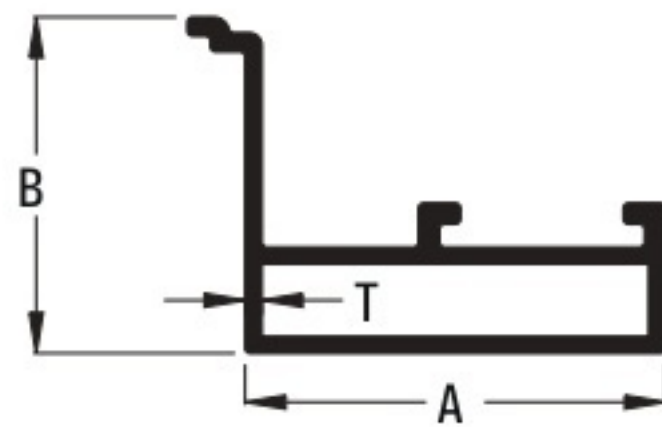

Sr. No	Section No.	A (mm)	B (mm)	T (mm)	Weight(Kg./Mtr)	Weight(Kg./12')
1	3826	40.00	32.00	1.60	0.574	2.100-2.600

MULLION

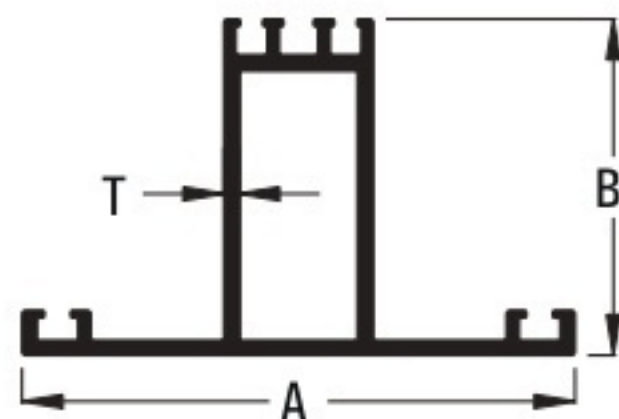

Sr. No	Section No.	A (mm)	B (mm)	T (mm)	Weight(Kg./Mtr)	Weight(Kg./12')
1	3827	74.00	45.00	2.00	1.066	3.900-4.500

MULLION

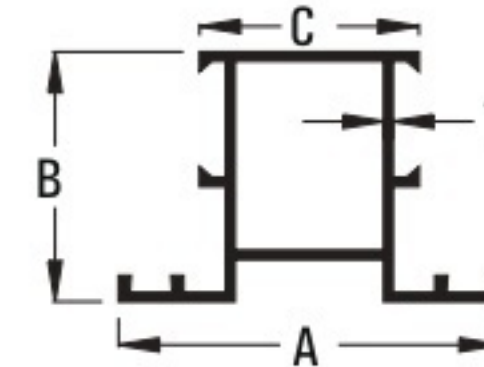

Sr. No	Section No.	A (mm)	B (mm)	C (mm)	T (mm)	Weight(Kg./Mtr)	Weight(Kg./12')
1	2422	58.80	38.50	33.80	1.40	0.656	2.40-2.60

'Z' Mullion

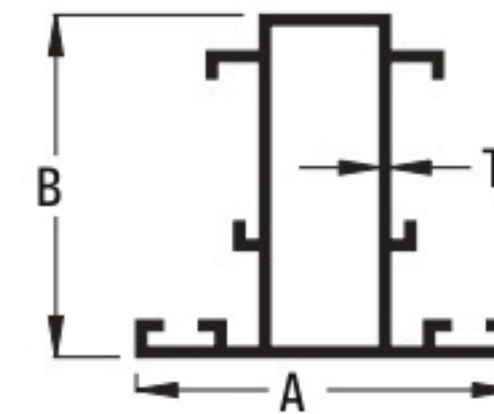

Sr. No	Section No.	A (mm)	B (mm)	T (mm)	Weight(Kg./Mtr)	Weight(Kg./12')
1	2431	46.50	42.20	1.45	0.765	2.80-3.00
2	2431L	46.50	42.20	1.20	0.628	2.30-2.50

Hollow 'Z'(D)

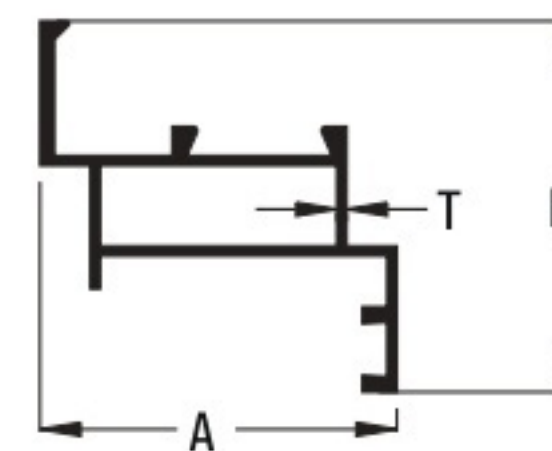

Sr. No	Section No.	A (mm)	B (mm)	T (mm)	Weight(Kg./Mtr)	Weight(Kg./12')
1	2423	44.00	45.75	1.20	0.492	1.80-2.00

'Z' Hollow(B)

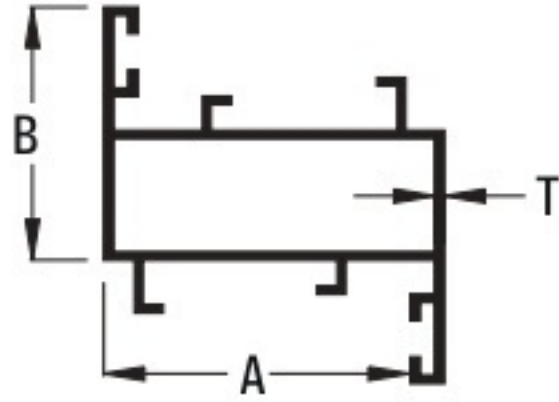

Sr. No	Section No.	A (mm)	B (mm)	T (mm)	Weight(Kg./Mtr)	Weight(Kg./12')
1	2430	42.00	31.20	1.45	0.765	2.80-3.0
2	2430L	42.00	31.20	1.10	0.574	2.10-2.30

CLIP

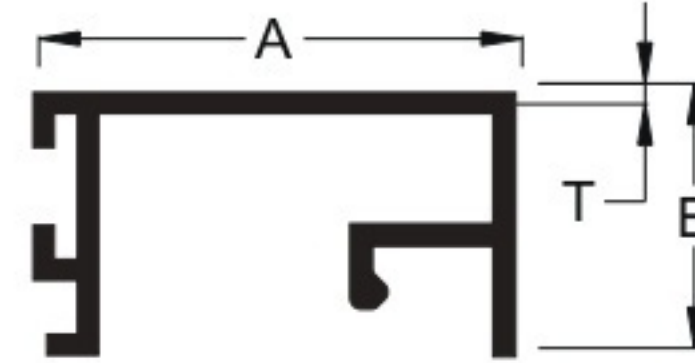

Sr. No	Section No.	A (mm)	B (mm)	T (mm)	Weight(Kg./Mtr)	Weight(Kg./12')
1	2428	28.33	15.99	1.20	0.246	0.90-1.00
2	2428L	28.33	15.99	0.75	0.164	0.600-0.800

'Z' Frame

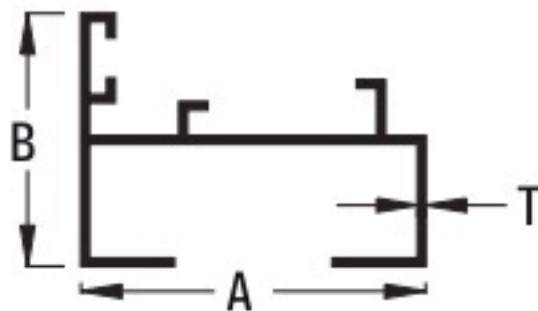

Sr. No	Section No.	A (mm)	B (mm)	T (mm)	Weight(Kg./Mtr)	Weight(Kg./12')
1	2429	42.50	31.20	1.35	0.492	1.80-2.00
2	2429L	42.50	31.20	1.10	0.410	1.50-1.70

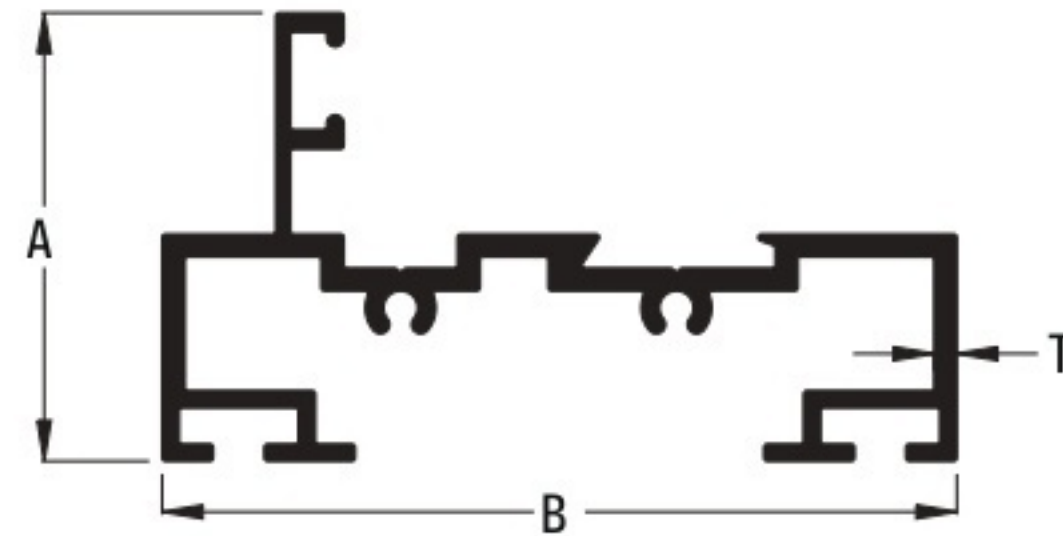

Sr. No	Section No.	A (mm)	B (mm)	T (mm)	Weight(Kg./Mtr)	Weight(Kg./12')
1	2451	39.5	70.0	2.0	0.984	3.60-3.80

Lame 'Z'

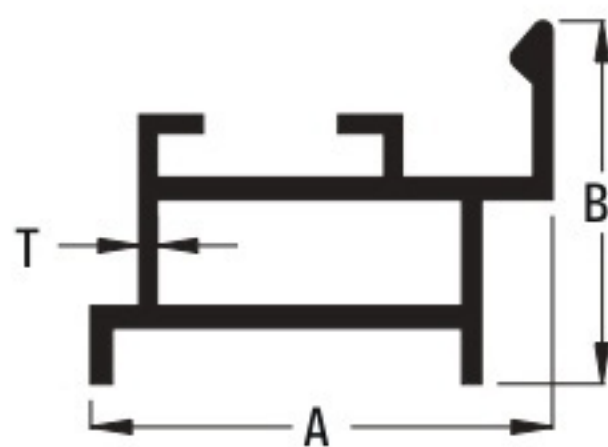

Sr. No	Section No.	A (mm)	B (mm)	T (mm)	Weight(Kg./Mtr)	Weight(Kg./12')
1	2426	46.00	33.90	2.10	0.711	2.60-2.80

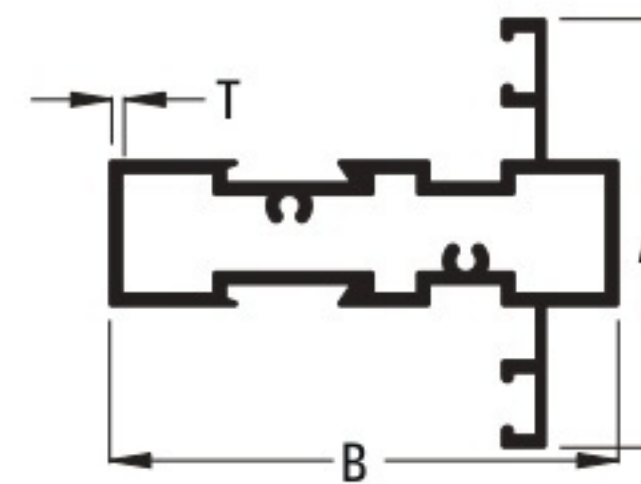

Sr. No	Section No.	A (mm)	B (mm)	T (mm)	Weight(Kg./Mtr)	Weight(Kg./12')
1	2452	59.0	70.0	1.70	1.202	4.40-4.60

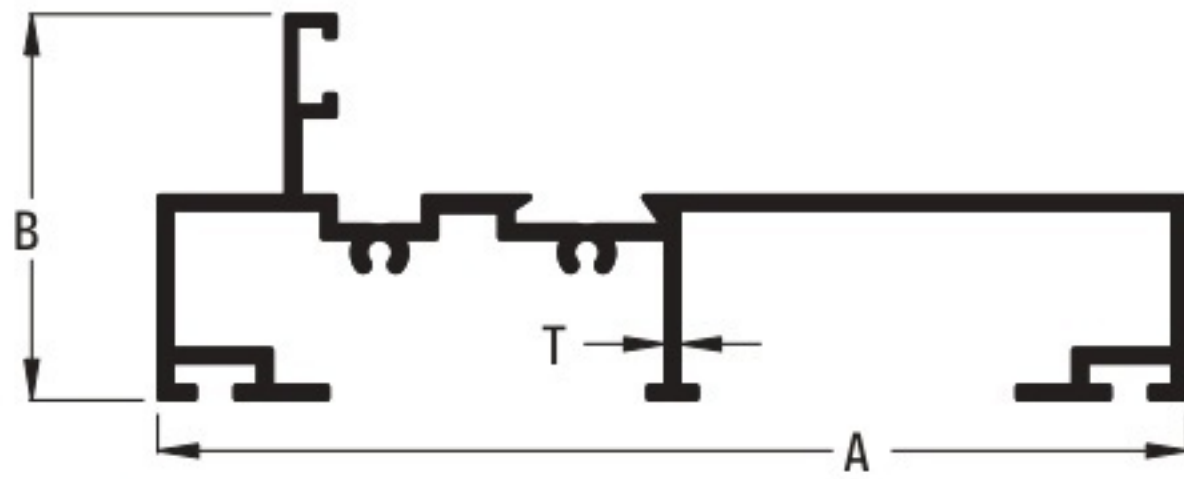

Sr. No	Section No.	A (mm)	B (mm)	T (mm)	Weight(Kg./Mtr)	Weight(Kg./12')
1	2501	120.0	45.0	1.80	1.476	5.40-5.60

Frame section

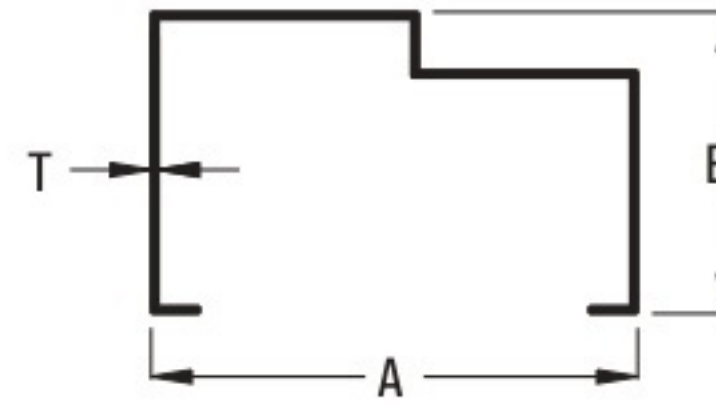

Sr. No	Section No.	A (mm)	B (mm)	T (mm)	Weight(Kg./Mtr)	Weight(Kg./12')
1	2434	100.00	62.00	1.50	0.929	3.40-3.60

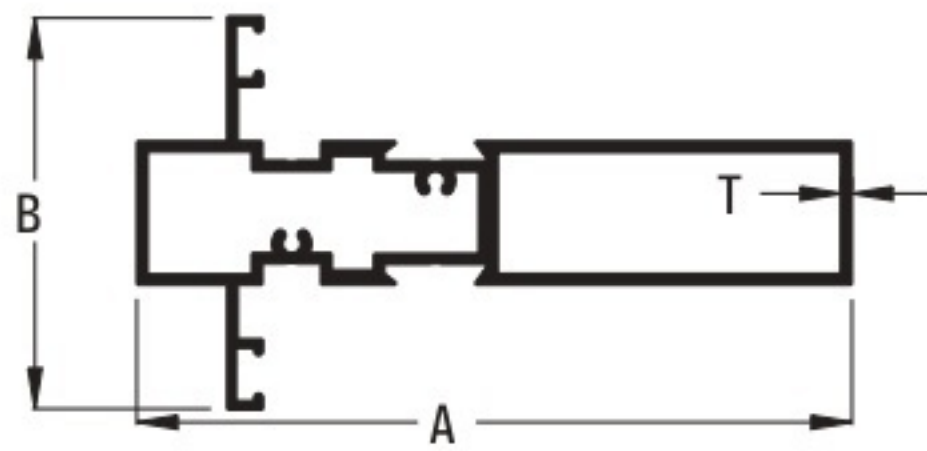

Sr. No	Section No.	A (mm)	B (mm)	T (mm)	Weight(Kg./Mtr)	Weight(Kg./12')
1	2502	119.25	65.65	1.80	2.009	7.35-7.55

Special Section

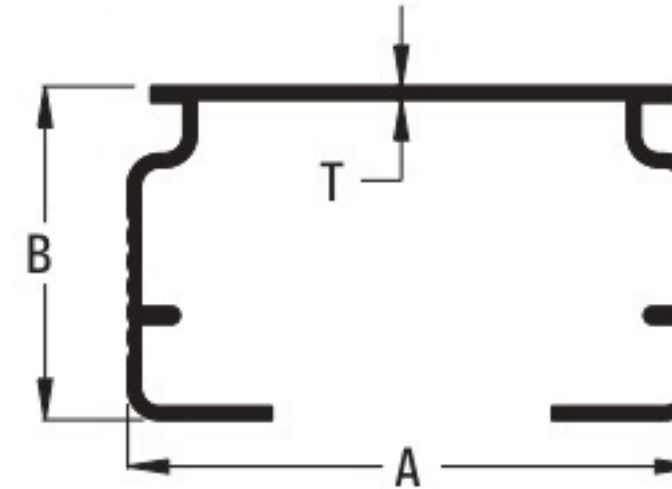

Sr. No	Section No.	A (mm)	B (mm)	T (mm)	Weight(Kg./Mtr)	Weight(Kg./12')
1	2438	43.80	25.70	1.00	0.219	0.80-1.00

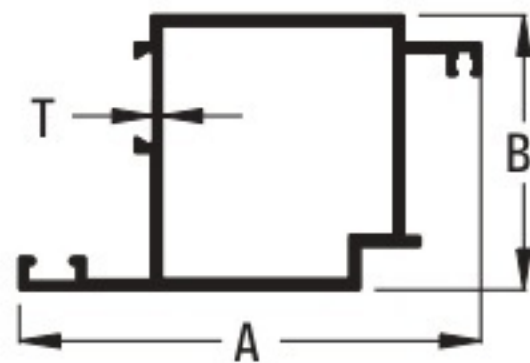

Sr. No	Section No.	A (mm)	B (mm)	T (mm)	Weight(Kg./Mtr)	Weight(Kg./12')
1	2503	84.0	50.0	1.85	1.203	4.40-4.60

Door Gear Section

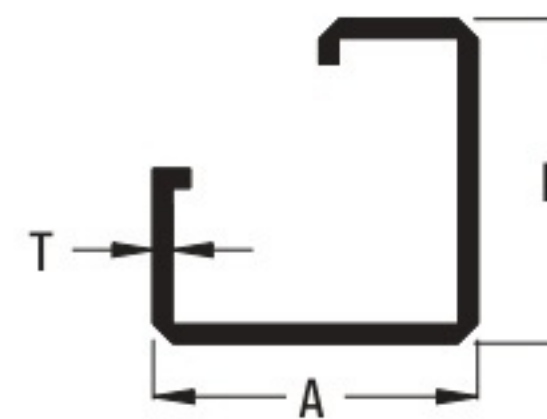

Sr. No	Section No.	A (mm)	B (mm)	T (mm)	Weight(Kg./Mtr)	Weight(Kg./12')
1	2439	40.00	40.00	2.30	0.683	2.50-2.70

Square Clip

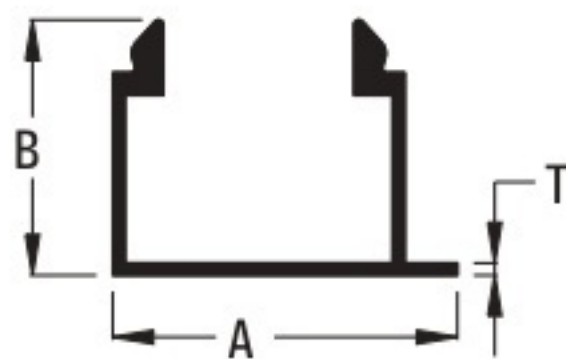

Sr. No	Section No.	A (mm)	B (mm)	T (mm)	Weight(Kg./Mtr)	Weight(Kg./12')
1	2421	21.25	15.75	0.75	0.131	0.48-0.52



Sr. No	Section No.	A (mm)	B (mm)	T (mm)	Weight(Kg./Mtr)	Weight(Kg./12')
1	2447	44.00	19.40	1.60	0.355	1.30-1.50

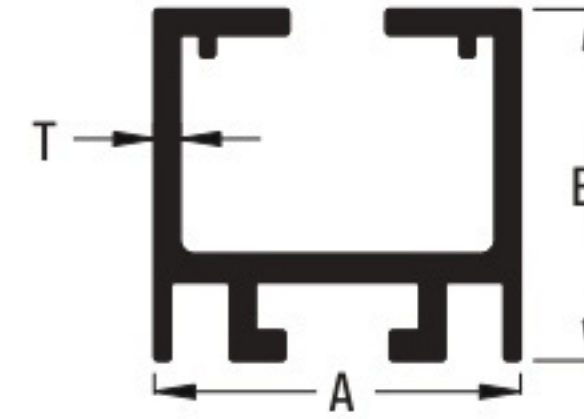

Sr. No	Section No.	A (mm)	B (mm)	T (mm)	Weight(Kg./Mtr)	Weight(Kg./12')
1	2460	49.00	47.00	3.40	1.804	6.600-7.000

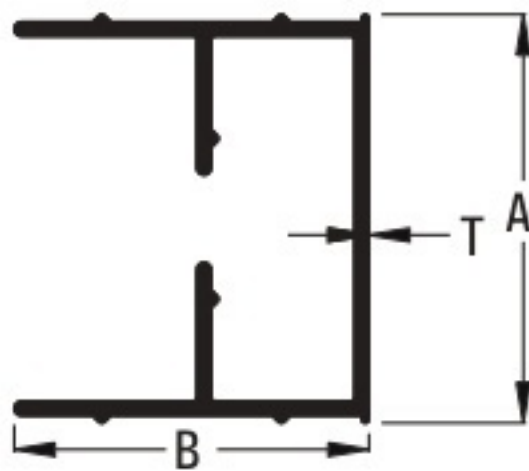

Sr. No	Section No.	A (mm)	B (mm)	T (mm)	Weight(Kg./Mtr)	Weight(Kg./12')
1	2456	28.00	24.30	1.00	0.246	0.900-1.200

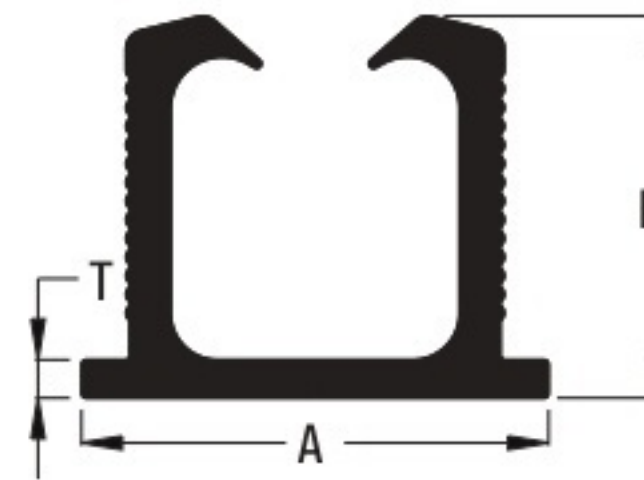

Sr. No	Section No.	A (mm)	B (mm)	T (mm)	Weight(Kg./Mtr)	Weight(Kg./12')
1	2463	50.00	40.90	4.10	1.613	5.900-6.400

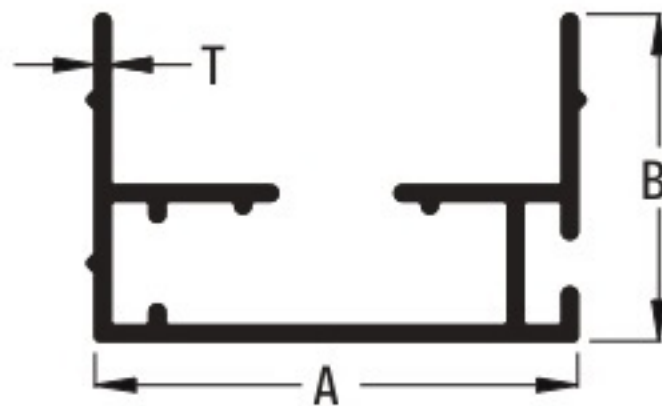

Sr. No	Section No.	A (mm)	B (mm)	T (mm)	Weight(Kg./Mtr)	Weight(Kg./12')
1	2457	31.00	21.00	1.00	0.273	1.00-1.200

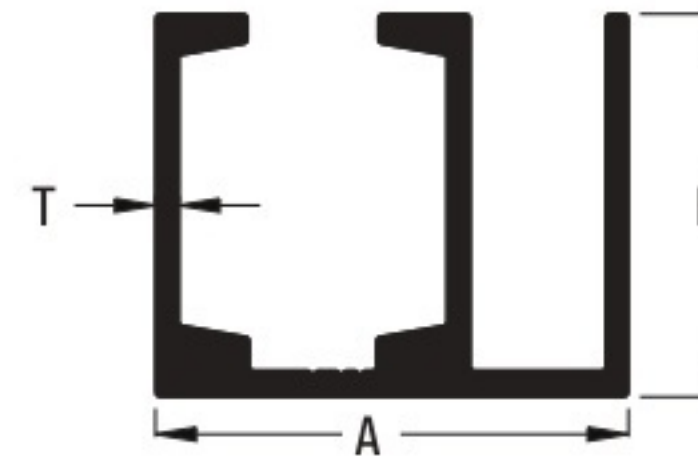

Sr. No	Section No.	A (mm)	B (mm)	T (mm)	Weight(Kg./Mtr)	Weight(Kg./12')
1	2464	50.00	40.50	2.50	1.422	5.200-5.600

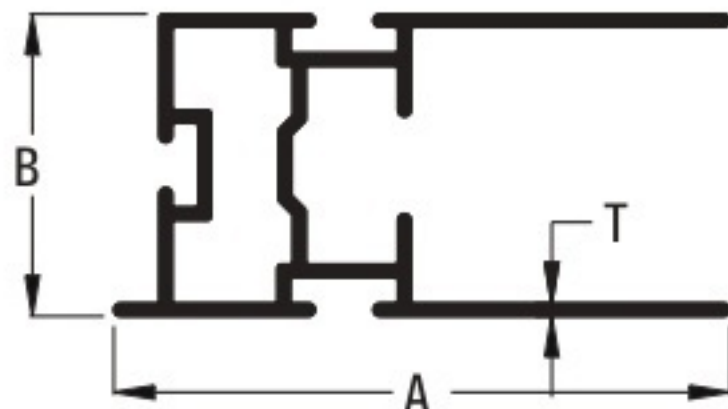

Sr. No	Section No.	A (mm)	B (mm)	T (mm)	Weight(Kg./Mtr)	Weight(Kg./12')
1	2458	47.50	23.30	1.00	0.437	1.600-1.900

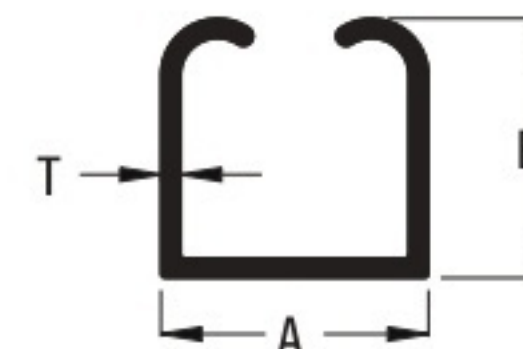

Sr. No	Section No.	A (mm)	B (mm)	T (mm)	Weight(Kg./Mtr)	Weight(Kg./12')
1	2466	33.00	32.00	2.45	0.683	2.500-2.700

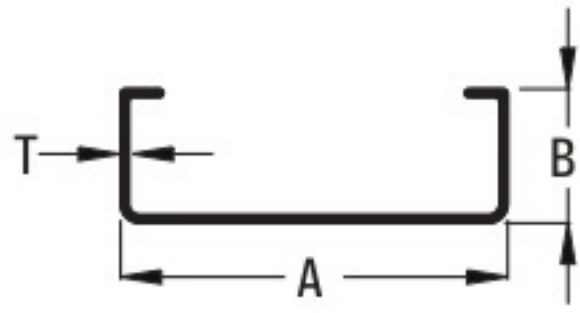

Sr. No	Section No.	A (mm)	B (mm)	T (mm)	Weight(Kg./Mtr)	Weight(Kg./12')
1	2467	39.80	13.80	0.85	0.164	0.600-0.800

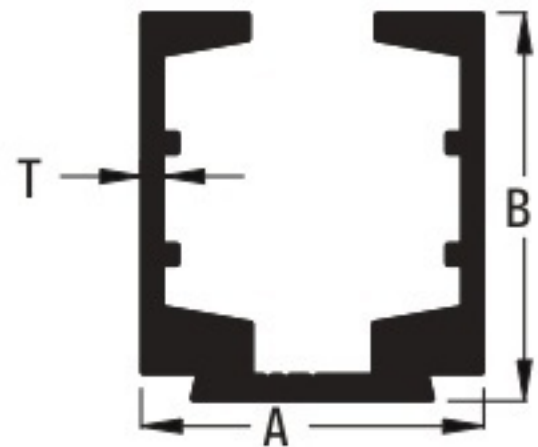

Sr. No	Section No.	A (mm)	B (mm)	T (mm)	Weight(Kg./Mtr)	Weight(Kg./12')
1	2487	38.40	43.50	2.50	1.339	4.90-5.10

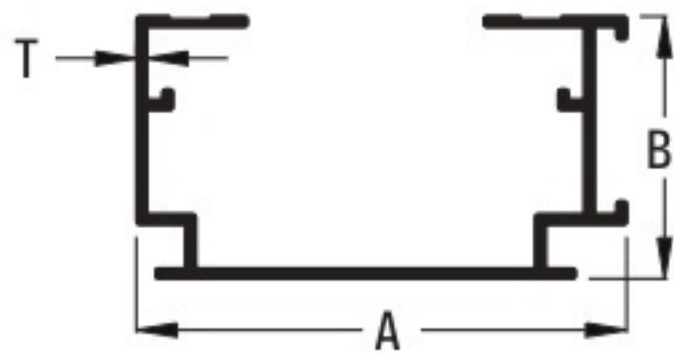

Sr. No	Section No.	A (mm)	B (mm)	T (mm)	Weight(Kg./Mtr)	Weight(Kg./12')
1	2498	47.10	25.2	1.00	0.355	1.30-1.50

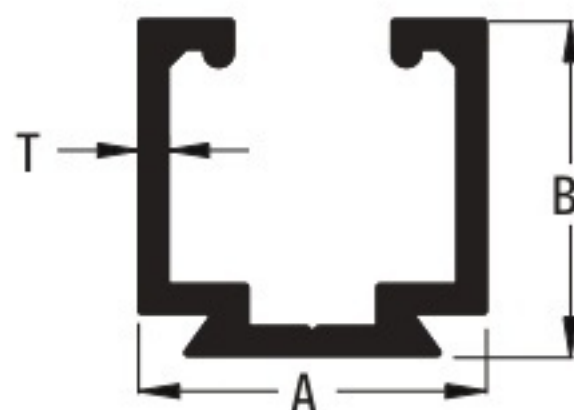

Sr. No	Section No.	A (mm)	B (mm)	T (mm)	Weight(Kg./Mtr)	Weight(Kg./12')
1	2500	33.00	31.90	2.80	0.861	3.15-3.35

LOCK SECTION

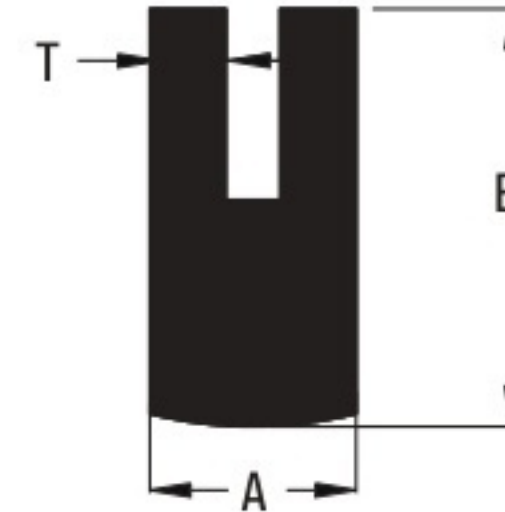

Sr. No	Section No.	A (mm)	B (mm)	T (mm)	Weight(Kg./Mtr)	Weight(Kg./12')
1	2510	8.0	16.20	2.95	0.314	1.150-1.350

LOCK SECTION

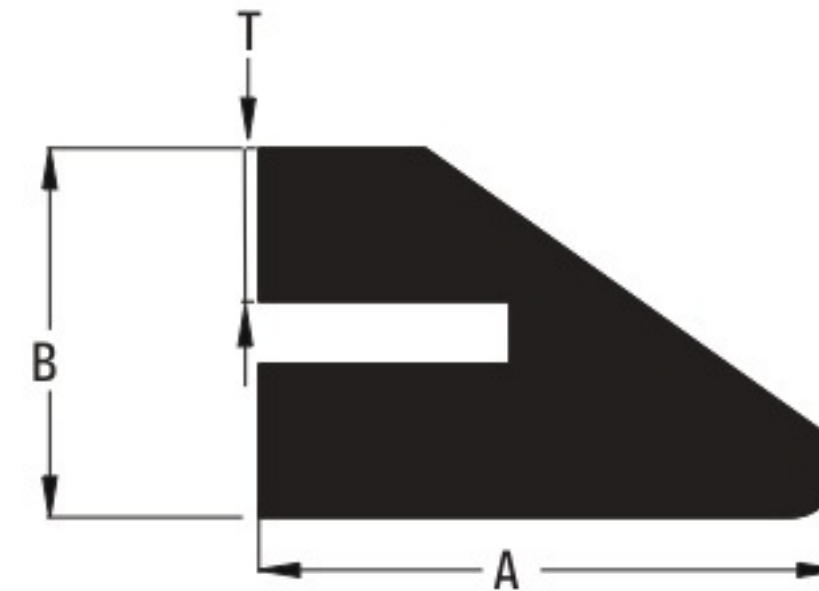

Sr. No	Section No.	A (mm)	B (mm)	T (mm)	Weight(Kg./Mtr)	Weight(Kg./12')
1	2511	15.70	10.0	4.15	0.273	1.000-1.200

Single Glass Section



Sr. No	Section No.	A (mm)	T (mm)	Weight(Kg./Mtr)	Weight(Kg./12')
1	3768	9.52	0.55	0.041	0.15-2.50
2	3769	12.70	0.70	0.068	0.25-0.35

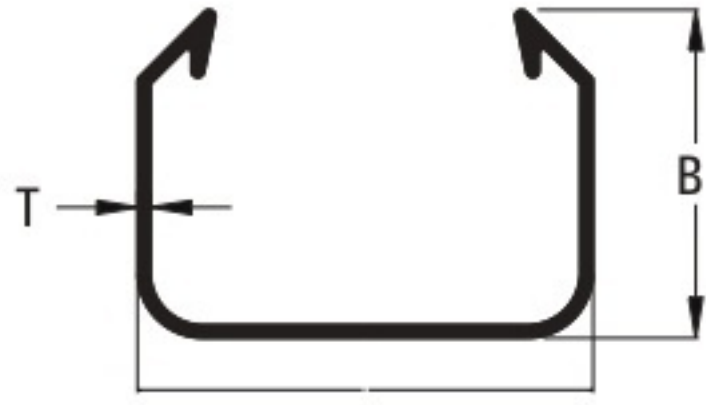

Sr. No	Section No.	A (mm)	B (mm)	T (mm)	Weight(Kg./Mtr)	Weight(Kg./12')
1	3770	34.70	25.00	1.00	0.246	0.900-1.200

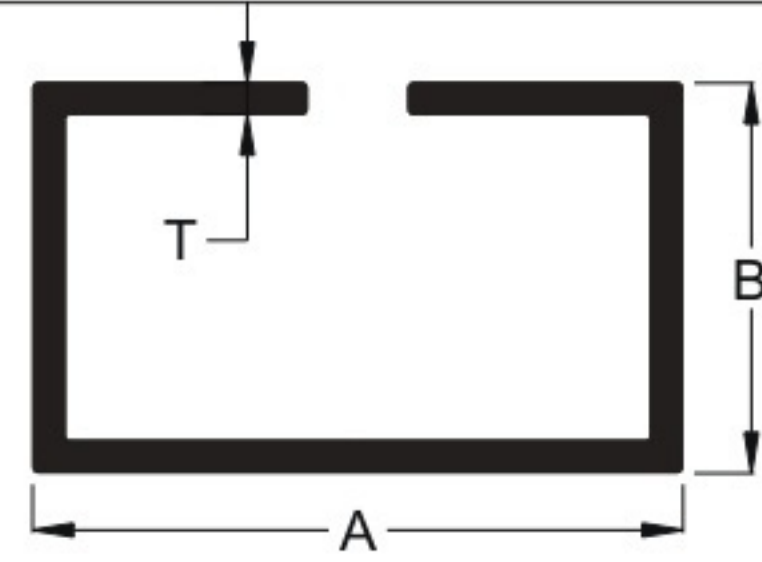

Sr. No	Section No.	A (mm)	B (mm)	T (mm)	Weight(Kg./Mtr)	Weight(Kg./12')
1	3777	63.50	38.10	3.10	1.476	5.400-5.800

C-CHANNEL



Sr. No	Section No.	A (mm)	B (mm)	T (mm)	Weight(Kg./Mtr)	Weight(Kg./12')
1	3771	65.00	8.50	1.20	0.246	0.900-1.100
2	3772	38.00	19.00	2.45	0.437	1.600-1.800



Sr. No	Section No.	A (mm)	B (mm)	T (mm)	Weight(Kg./Mtr)	Weight(Kg./12')
1	3778	13.05	17.00	5.20	0.410	1.500-1.800

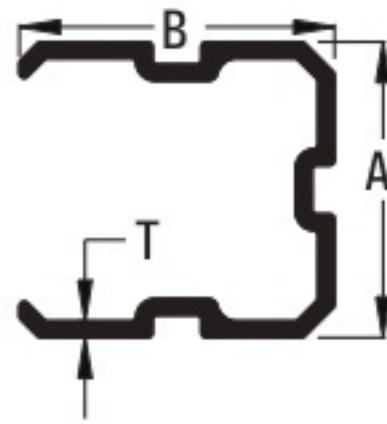

Sr. No	Section No.	A (mm)	B (mm)	T (mm)	Weight(Kg./Mtr)	Weight(Kg./12')
1	3773	15.20	16.20	0.85	0.109	0.400-6.00



Sr. No	Section No.	A (mm)	B (mm)	T (mm)	Weight(Kg./Mtr)	Weight(Kg./12')
1	3779	36.50	13.05	5.20	1.094	4.000-4.200



Sr. No	Section No.	A (mm)	B (mm)	Weight(Kg./Mtr)	Weight(Kg./12')
1	3774	39.70	16.00	1.312	4.800-5.100
2	3775	19.00	4.90	0.164	0.600-0.900



Sr. No	Section No.	A (mm)	B (mm)	T (mm)	Weight(Kg./Mtr)	Weight(Kg./12')
1	3727	42.0	32.0	12.0	2.652	9.700-10.000

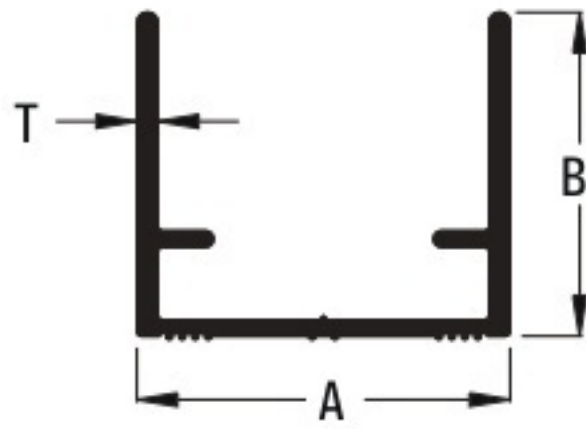

Sr. No	Section No.	A (mm)	B (mm)	T (mm)	Weight(Kg./Mtr)	Weight(Kg./12')
1	2491	23.05	20.0	1.30	0.191	0.700-1.200

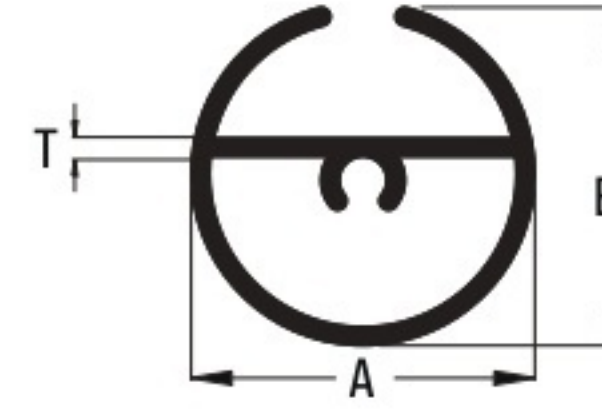

Sr. No	Section No.	A (mm)	B (mm)	T (mm)	Weight(Kg./Mtr)	Weight(Kg./12')
1	2499	21.20	20.85	1.10	0.262	0.960-1.260

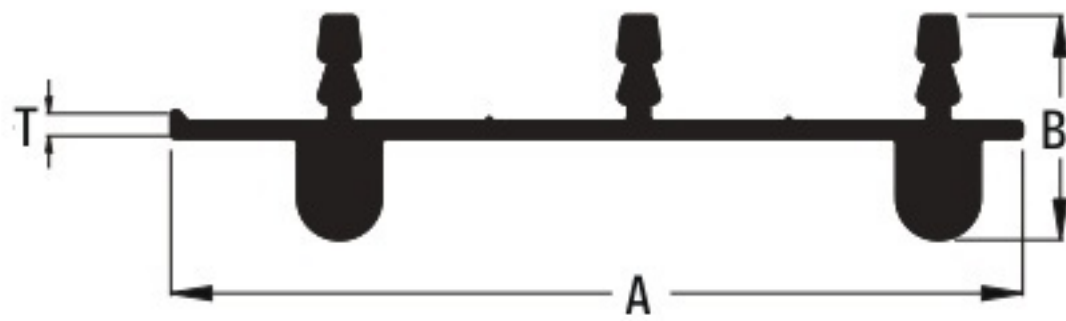

Sr. No	Section No.	A (mm)	B (mm)	T (mm)	Weight(Kg./Mtr)	Weight(Kg./12')
1	2492	50.5	13.30	1.05	0.383	1.400-1.600

'C' Handle

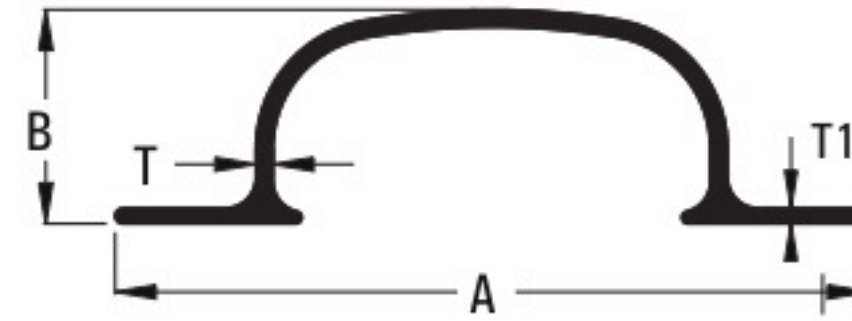

Sr. No	Section No.	A (mm)	B (mm)	T (mm)	T1 (mm)	Weight(Kg./Mtr)	Weight(Kg./12')
1	3870	145.0	38.0	3.0	2.50	1.504	5.500-6.00
2	3871	121.0	34.50	2.80	2.50	1.312	4.800-5.300
3	3872	120.0	33.30	1.55	1.35	0.738	2.700-3.00
4	3873	120.0	33.30	2.20	2.00	1.040	3.800-4.00

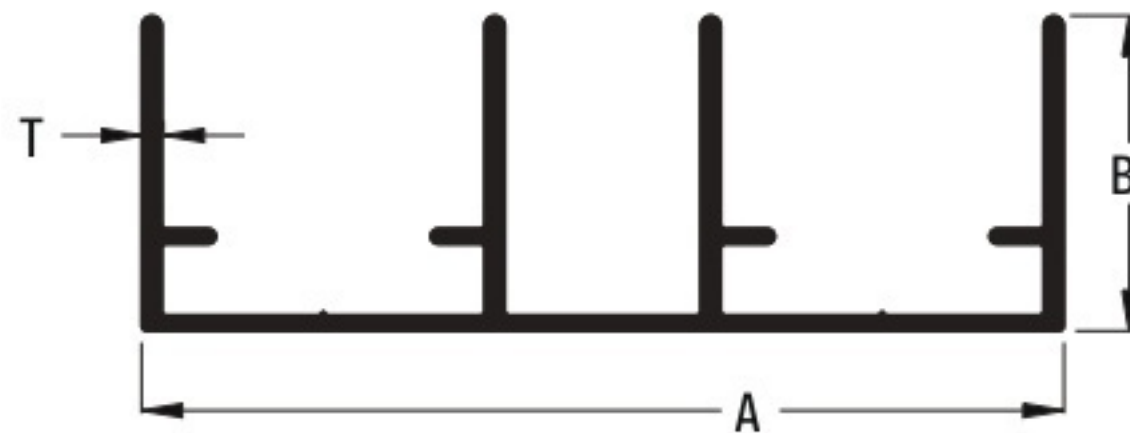

Sr. No	Section No.	A (mm)	B (mm)	T (mm)	Weight(Kg./Mtr)	Weight(Kg./12')
1	2493	58.50	20.0	1.30	0.437	1.600-1.800

'D' Handle

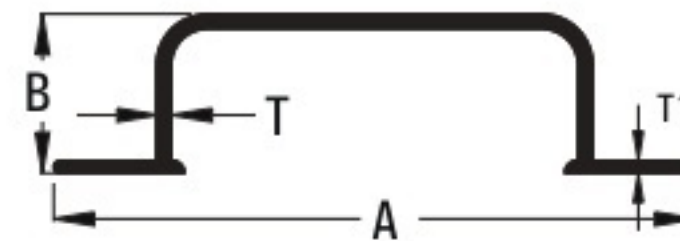

Sr. No	Section No.	A (mm)	B (mm)	T (mm)	T1 (mm)	Weight(Kg./Mtr)	Weight(Kg./12')
1	3819	146.0	31.0	3.10	2.50	1.586	5.800-6.200
2	3820	125.0	31.0	2.90	2.40	1.312	4.800-5.300

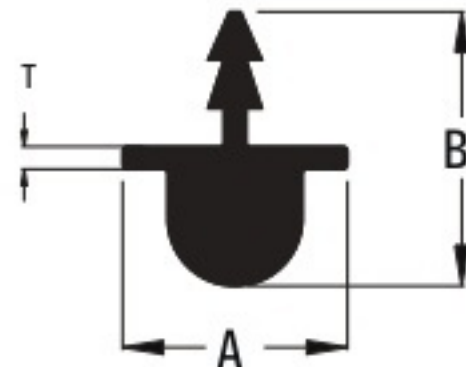

Sr. No	Section No.	A (mm)	B (mm)	T (mm)	Weight(Kg./Mtr)	Weight(Kg./12')
1	2517	10.00	12.20	1.00	0.127	0.465-0.700

HANDLE



Sr. No	Section No.	A (mm)	B (mm)	T (mm)	Weight(Kg./Mtr)	Weight(Kg./12')
1	3822	46.50	15.40	1.70	0.437	1.600-1.800

Handle



Sr. No	Section No.	A (mm)	B (mm)	Weight(Kg./Mtr)	Weight(Kg./12')
1	3821	46.85	21.05	0.519	1.900-2.20

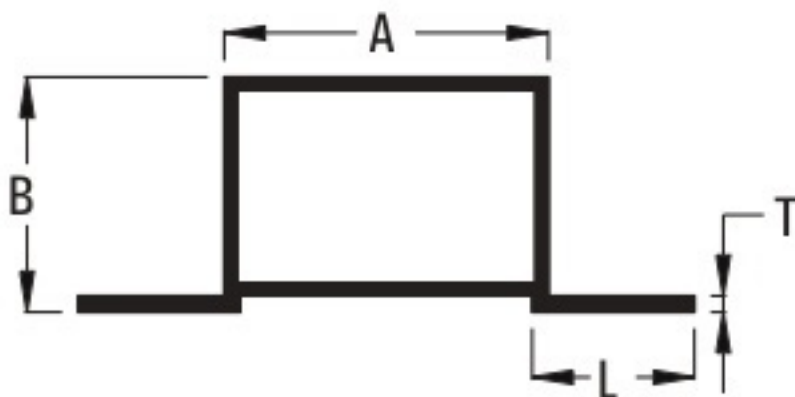

Sr. No	Section No.	A (mm)	B (mm)	L (mm)	T (mm)	Weight(Kg./Mtr)	Weight(Kg./12')
1	2414	40.00	29.00	20.00	2.00	0.765	2.80-3.20

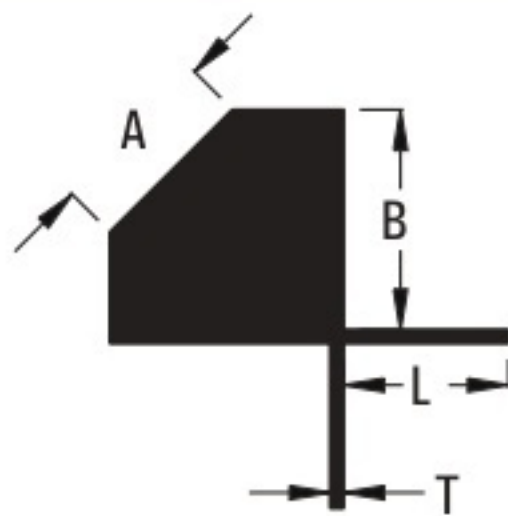

Sr. No	Section No.	A (mm)	B (mm)	L (mm)	T (mm)	Weight(Kg./Mtr)	Weight(Kg./12')
1	2399	21.00	26.70	20.00	1.60	0.574	2.10-2.40

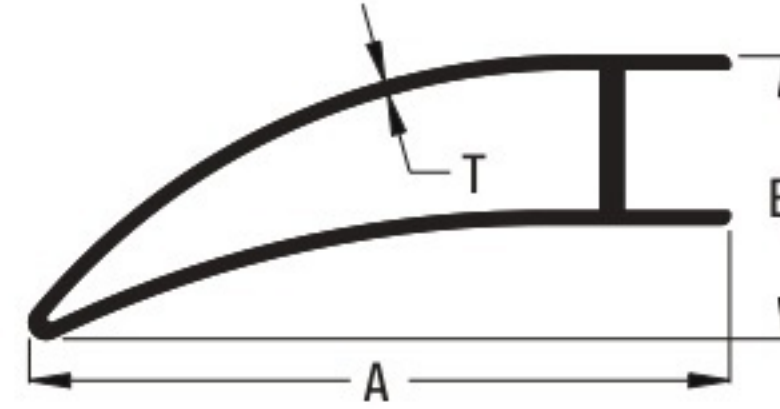

Sr. No	Section No.	A (mm)	B (mm)	T (mm)	Weight(Kg./Mtr)	Weight(Kg./12')
1	3950	125.0	50.50	2.25	1.897	6.940-7.400

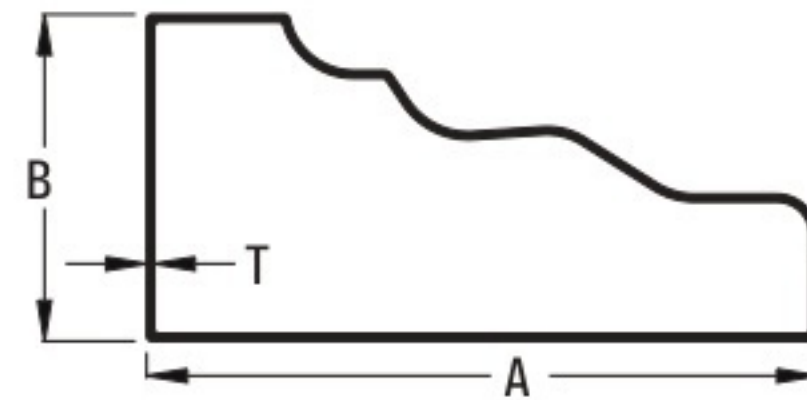

Sr. No	Section No.	A (mm)	B (mm)	T (mm)	Weight(Kg./Mtr)	Weight(Kg./12')
1	3955	67.50	32.0	0.75	0.383	1.400-1.600

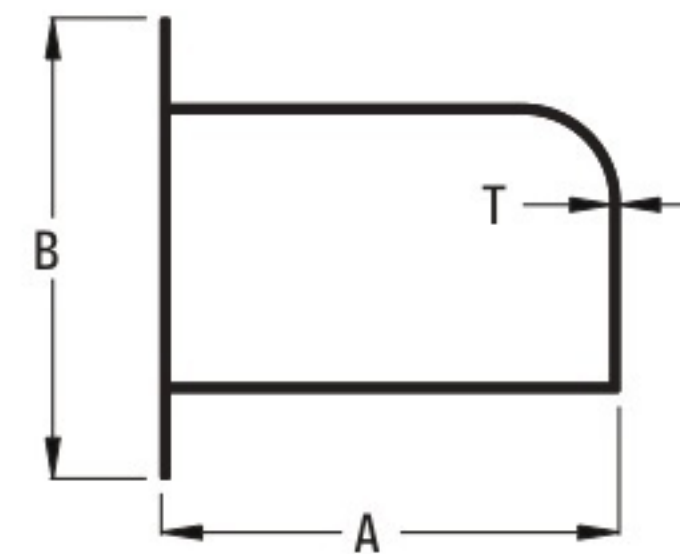

Sr. No	Section No.	A (mm)	B (mm)	T (mm)	Weight(Kg./Mtr)	Weight(Kg./12')
1	2486	84.5	85.00	1.5	1.148	4.200-4.400

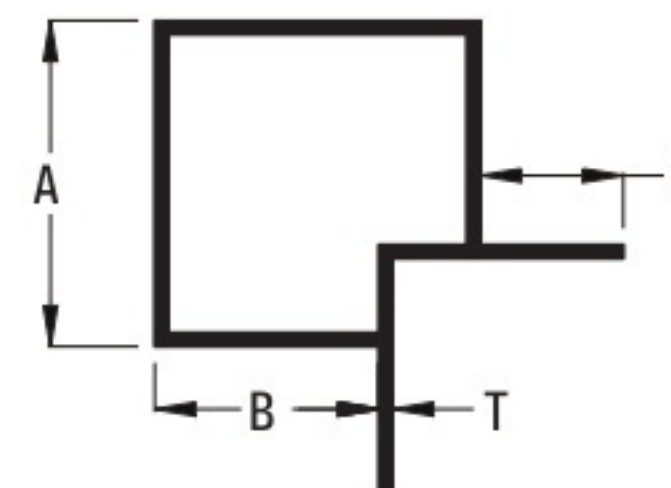

Sr. No	Section No.	A (mm)	B (mm)	L (mm)	T (mm)	Weight(Kg./Mtr)	Weight(Kg./12')
1	2398	40.00	27.50	17.50	1.70	0.847	3.10-3.30
2	2425	50.00	27.50	17.50	1.85	0.929	3.40-3.60

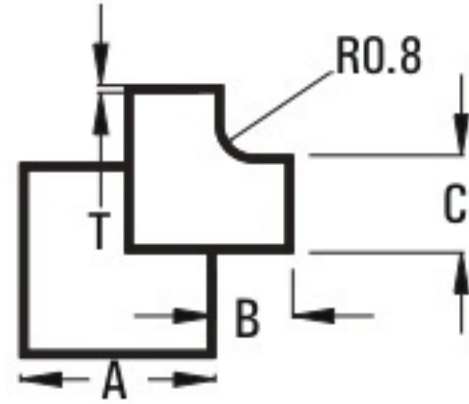

Sr. No	Section No.	A (mm)	B (mm)	C (mm)	T (mm)	Weight(Kg./Mtr)	Weight(Kg./12')
1	2420	50.00	20.00	27.00	1.70	1.339	4.90-5.20

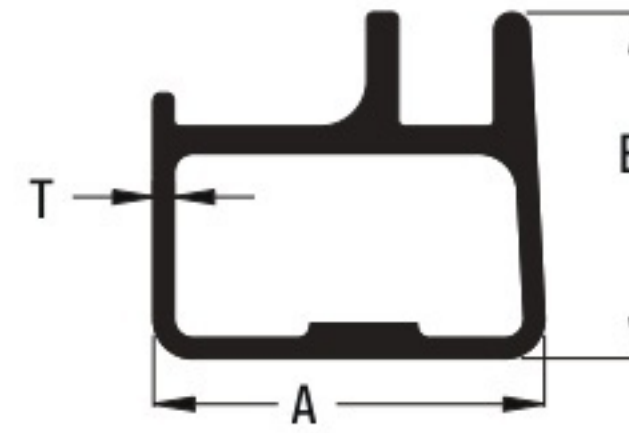

Sr. No	Section No.	A (mm)	B (mm)	T (mm)	Weight(Kg./Mtr)	Weight(Kg./12')
1	2509	58.85	52.18	3.00	2.187	8.000-8.200

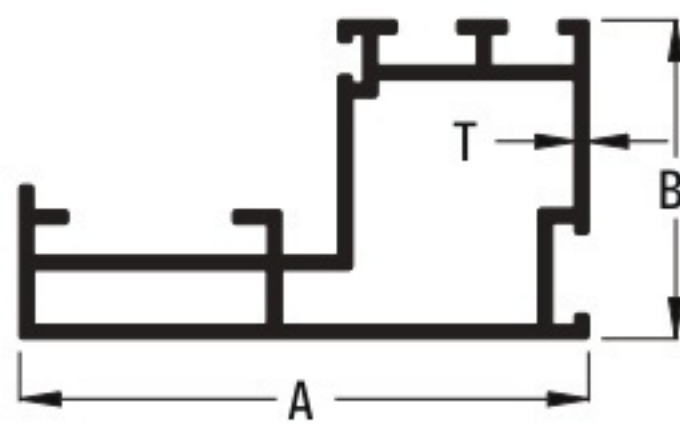

Sr. No	Section No.	A (mm)	B (mm)	T (mm)	Weight(Kg./Mtr)	Weight(Kg./12')
1	2506	50.0	28.0	1.20	0.629	2.300-2.500

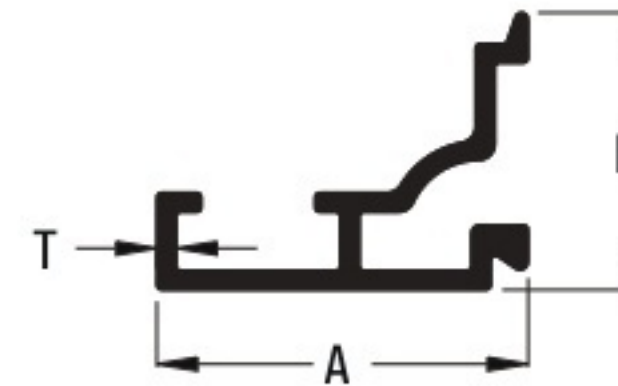

Sr. No	Section No.	A (mm)	B (mm)	T (mm)	Weight(Kg./Mtr)	Weight(Kg./12')
1	2448	22.90	17.10	1.20	0.191	0.70-0.90

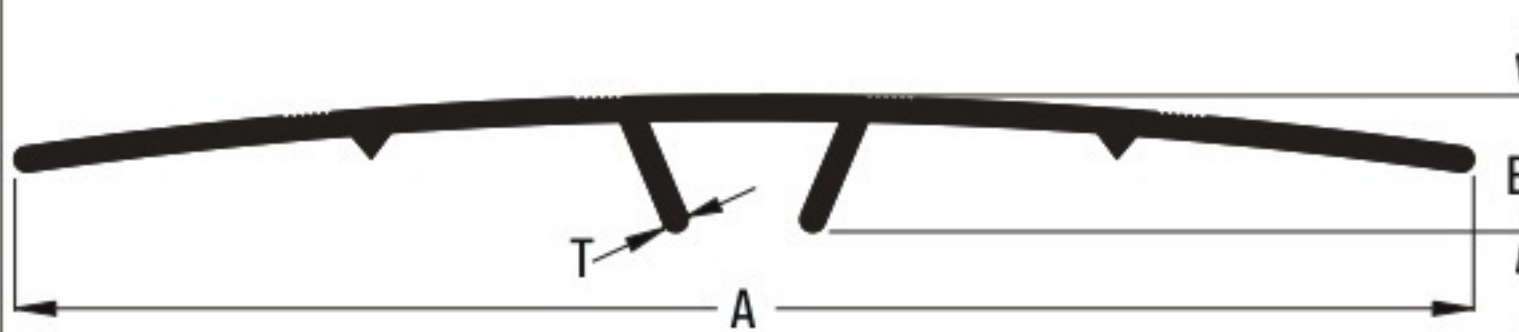

Sr. No	Section No.	A (mm)	B (mm)	T (mm)	Weight(Kg./Mtr)	Weight(Kg./12')
1	2507	90.0	8.40	1.50	0.429	1.570-1.770



Sr. No	Section No.	A (mm)	B (mm)	T (mm)	Weight(Kg./Mtr)	Weight(Kg./12')
1	2420	43.70	2.80	0.50	0.109	0.400-0.600

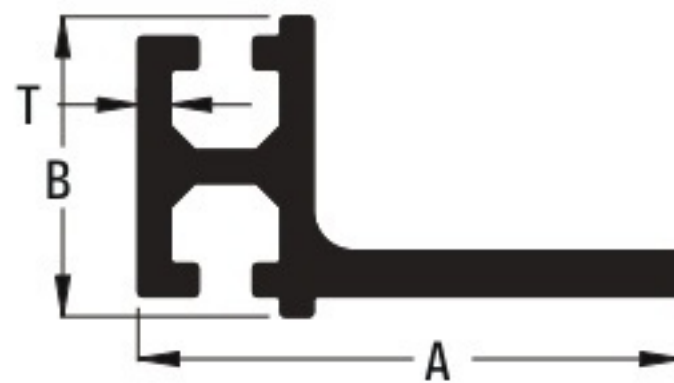

Sr. No	Section No.	A (mm)	B (mm)	T (mm)	Weight(Kg./Mtr)	Weight(Kg./12')
1	2508	33.50	18.50	2.0	0.451	1.650-1.850

Oval Tube

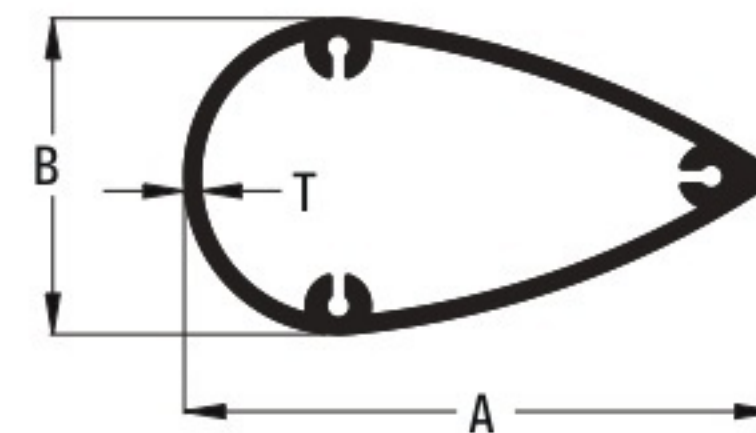

Sr. No	Section No.	A (mm)	B (mm)	T (mm)	Weight(Kg./Mtr)	Weight(Kg./12')
1	2444	73.00	39.00	2.00	1.094	4.00-4.40

Trisul Section

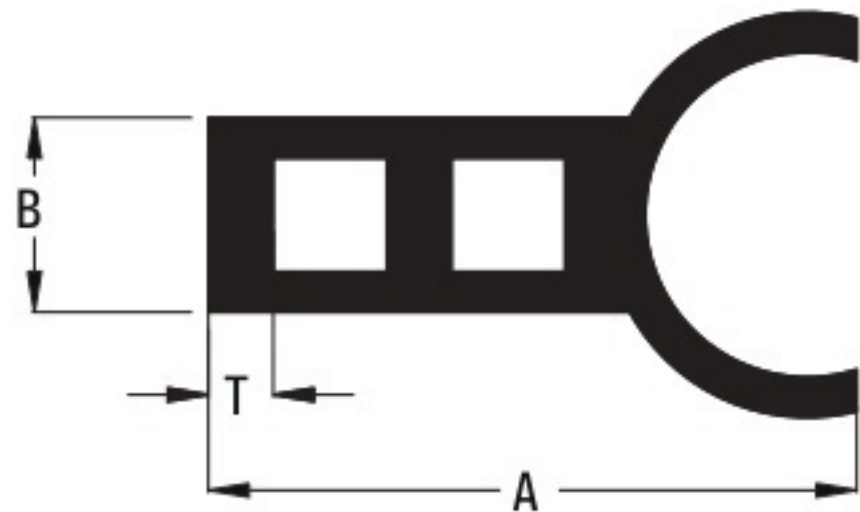

Sr. No	Section No.	A (mm)	B (mm)	T (mm)	Weight(Kg./Mtr)	Weight(Kg./12')
1	2445	80.00	24.00	8.00	3.280	12.00-13.00

Glass Section(hathi)

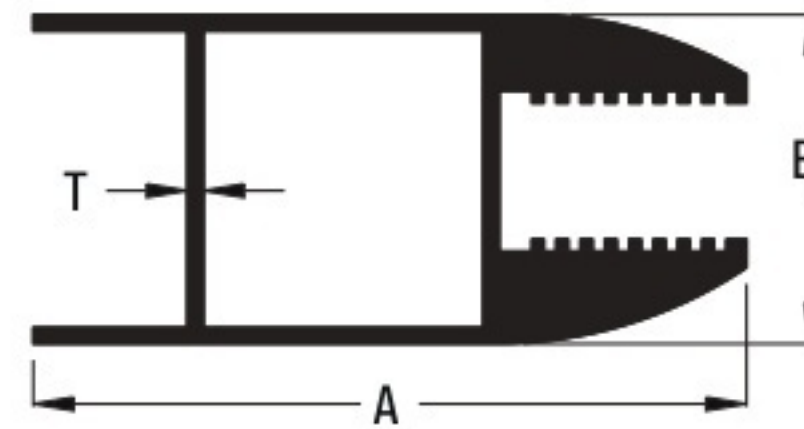

Sr. No	Section No.	A (mm)	B (mm)	T (mm)	Weight(Kg./Mtr)	Weight(Kg./12')
1	2364	88.00	40.60	2.00	2.460	9.00-10.00

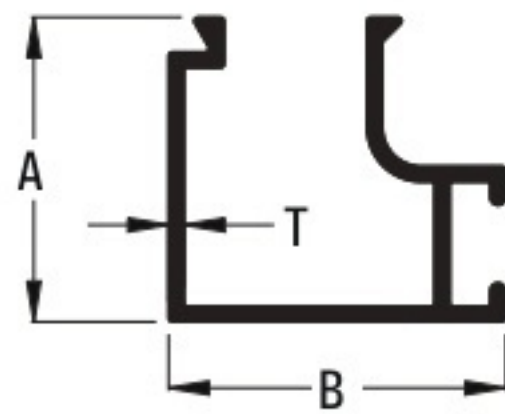

Sr. No	Section No.	A (mm)	B (mm)	T (mm)	Weight(Kg./Mtr)	Weight(Kg./12')
1	2450	23.50	26.0	1.20	0.219	0.80-1.10

Frame Section & Sub-Frame Section



Sr. No	Section No.	A (mm)	B (mm)	T (mm)	Weight(Kg./Mtr)	Weight(Kg./12')
1	2484	101.6	17.9	1.5	0.601	2.200-2.400

Glazing Clip

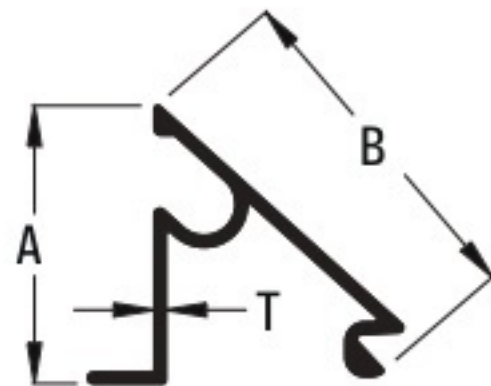

Sr. No	Section No.	A (mm)	B (mm)	T (mm)	Weight(Kg./Mtr)	Weight(Kg./12')
1	2404	17.15	22.55	0.50	0.076	0.28-0.32
2	2405	17.15	22.55	0.70	0.090	0.33-0.38
3	2406	17.15	22.55	0.85	0.109	0.400-0.460

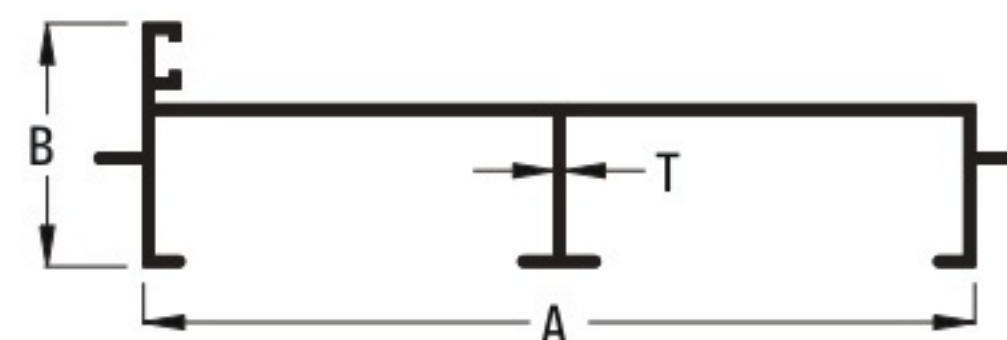

Sr. No	Section No.	A (mm)	B (mm)	T (mm)	Weight(Kg./Mtr)	Weight(Kg./12')
1	2443	102.55	30.00	1.25	0.683	2.50-2.80

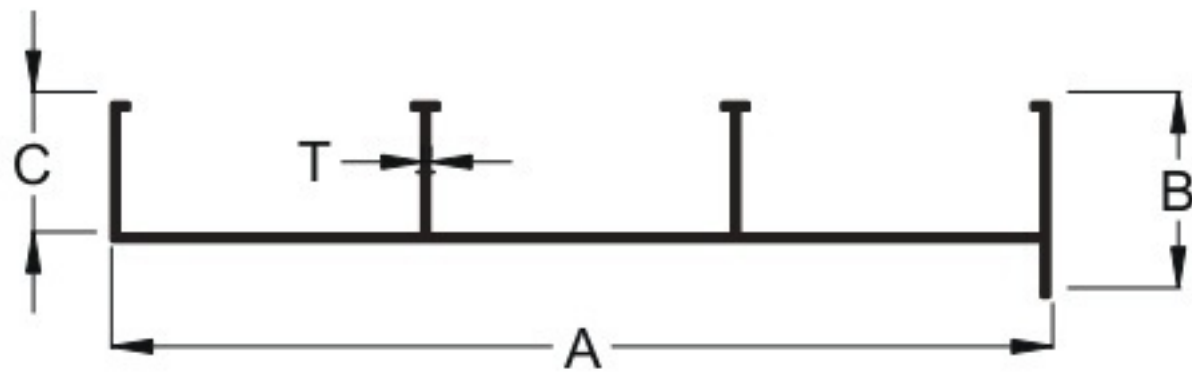

Sr. No	Section No.	A (mm)	B (mm)	C (mm)	T (mm)	Weight(Kg./Mtr)	Weight(Kg./12')
1	2552	168.00	35.00	25.00	1.50	1.148	4.200-4.500

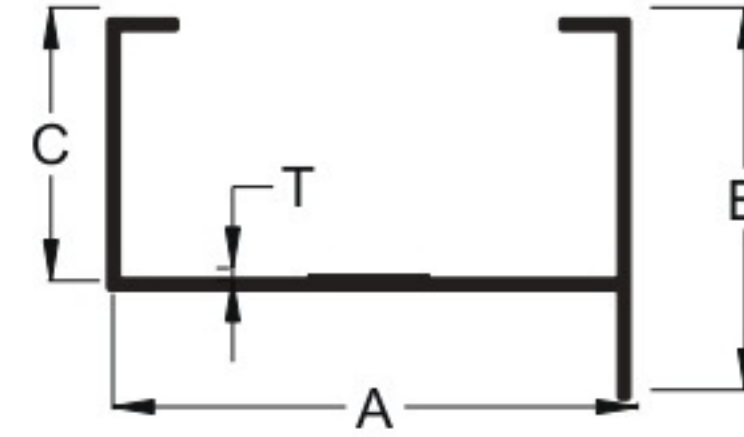

Sr. No	Section No.	A (mm)	B (mm)	C (mm)	T (mm)	Weight(Kg./Mtr)	Weight(Kg./12')
1	2556	48.00	35.00	25.00	1.15	0.369	1.350-1.500



Sr. No	Section No.	A (mm)	B (mm)	C (mm)	T (mm)	Weight(Kg./Mtr)	Weight(Kg./12')
1	2553	127.00	35.00	25.00	1.55	1.011	3.700-3.900

Louver

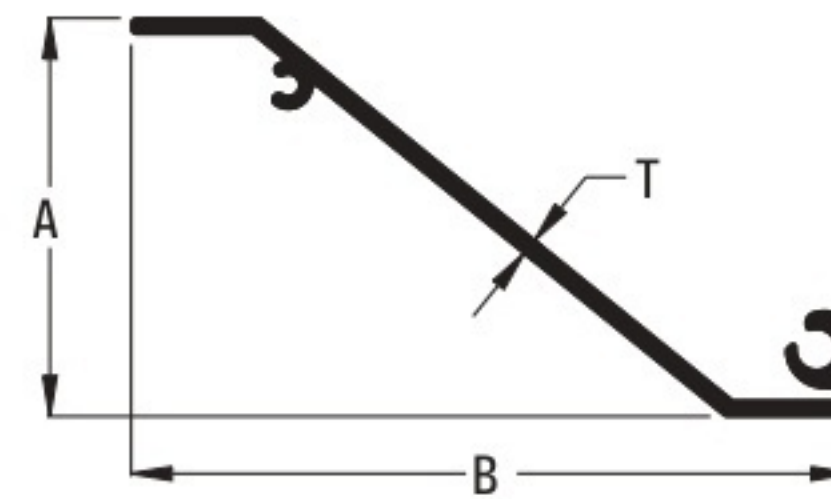

Sr. No	Section No.	A (mm)	B (mm)	T (mm)	Weight(Kg./Mtr)	Weight(Kg./12')
1	2449	35.10	63.5	1.5	0.383	1.40-1.60

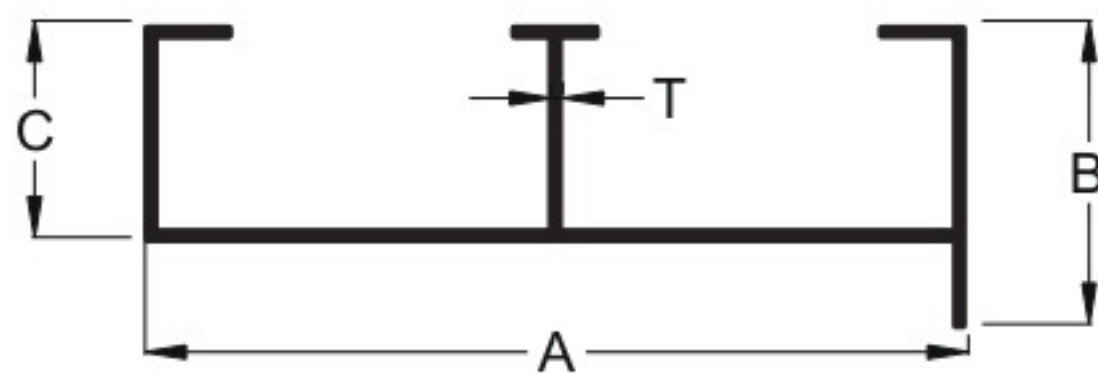

Sr. No	Section No.	A (mm)	B (mm)	C (mm)	T (mm)	Weight(Kg./Mtr)	Weight(Kg./12')
1	2554	95.00	35.00	25.00	1.40	0.765	2.800-3.00

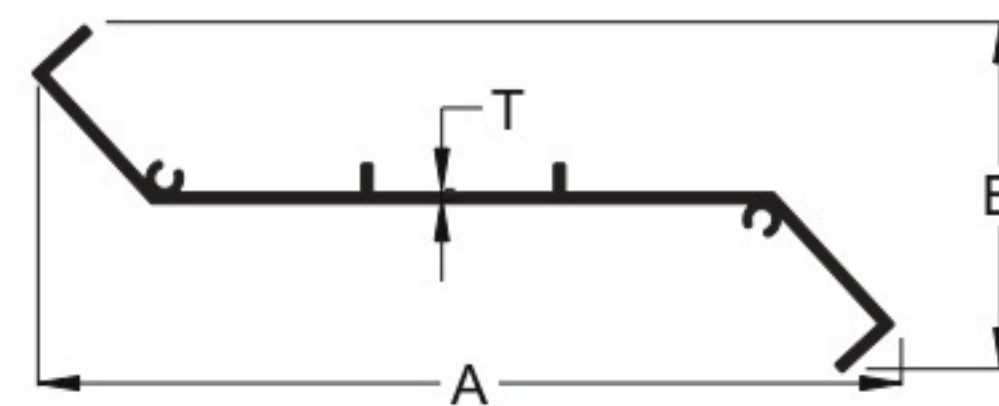

Sr. No	Section No.	A (mm)	B (mm)	T (mm)	Weight(Kg./Mtr)	Weight(Kg./12')
1	2558	118.50	47.60	1.50	0.683	2.500-2.700

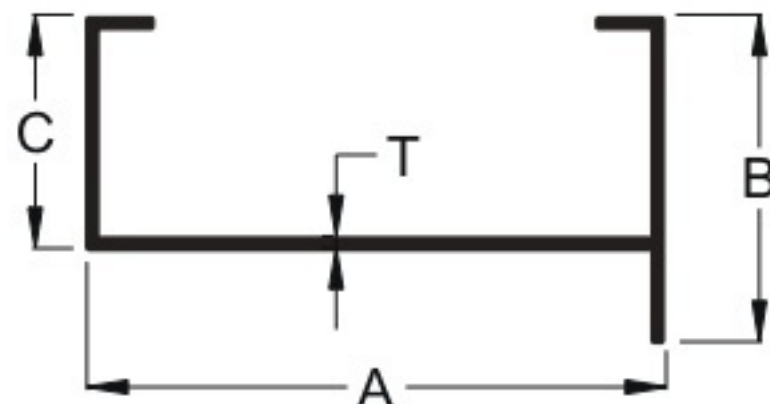

Sr. No	Section No.	A (mm)	B (mm)	C (mm)	T (mm)	Weight(Kg./Mtr)	Weight(Kg./12')
1	2555	62.00	35.00	25.00	1.30	0.465	1.700-1.900

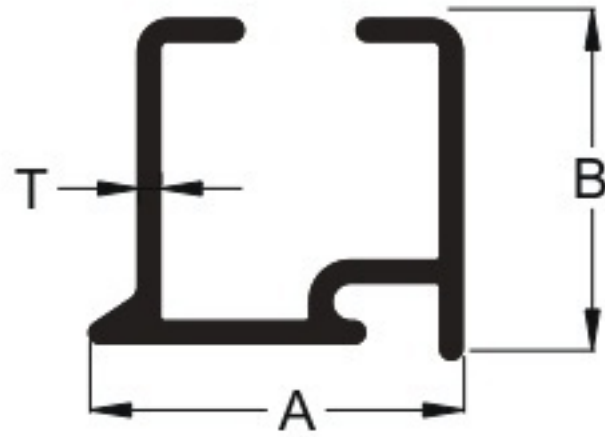

Sr. No	Section No.	A (mm)	B (mm)	Weight(Kg./Mtr)	Weight(Kg./12')
1	3784	23.0	21.0	0.273	1.00-1.20



Sr. No	Section No.	A (mm)	B (mm)	T (mm)	Weight(Kg./Mtr)	Weight(Kg./12')
1	2544	34.50	10.50	2.00	0.341	1.250-1.450

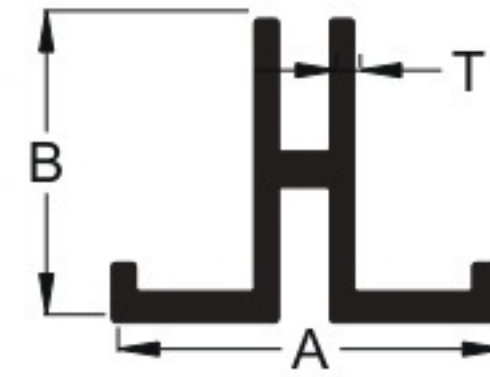

Sr. No	Section No.	A (mm)	B (mm)	T (mm)	Weight(Kg./Mtr)	Weight(Kg./12')
1	2545	31.15	24.55	1.90	0.465	1.700-1.900



Sr. No	Section No.	A (mm)	B (mm)	T (mm)	Weight(Kg./Mtr)	Weight(Kg./12')
1	2521	16.00	8.00	4.20	0.178	0.650-0.750

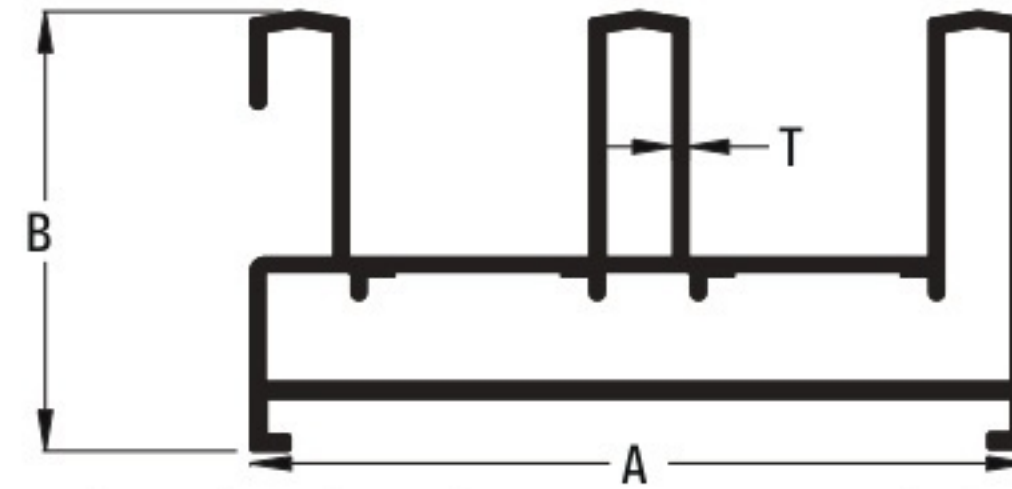

Sr. No	Section No.	A (mm)	B (mm)	T (mm)	Weight(Kg./Mtr)	Weight(Kg./12')
1	6098	79.9	40	1.7	1.531	5.600-5.800

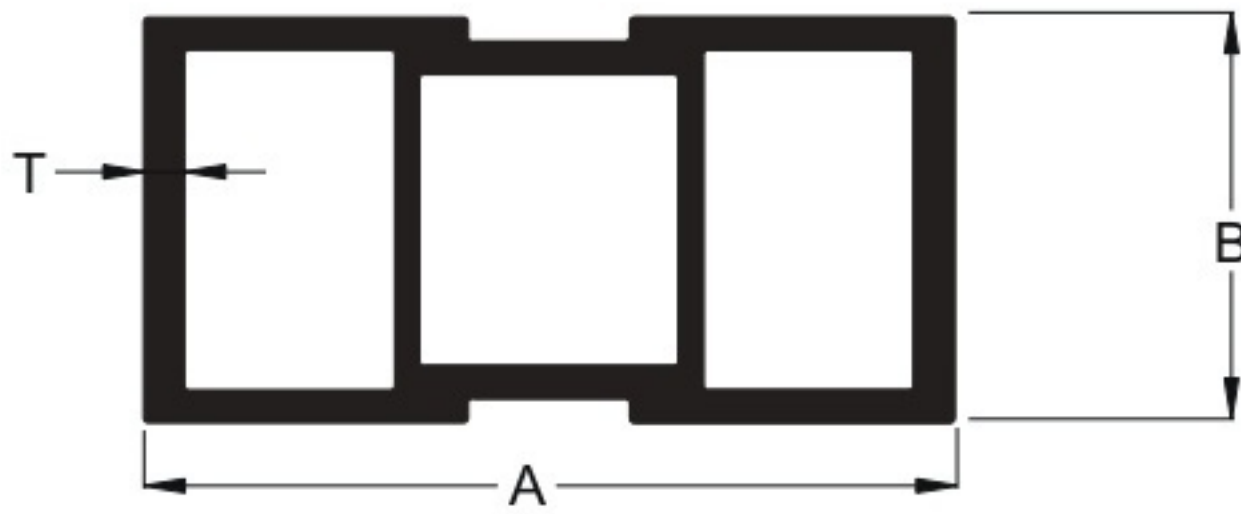

Sr. No	Section No.	A (mm)	B (mm)	T (mm)	Weight(Kg./Mtr)	Weight(Kg./12')
1	2540	50.0	25.0	2.50	1.039	3.80-4.00

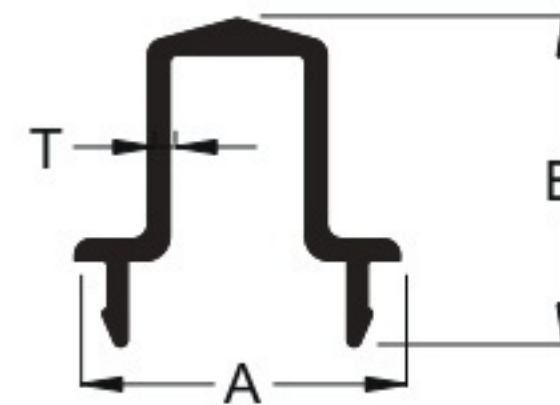

Sr. No	Section No.	A (mm)	B (mm)	T (mm)	Weight(Kg./Mtr)	Weight(Kg./12')
1	2547	20.00	20.20	1.30	0.191	0.700-0.900



Sr. No	Section No.	A (mm)	B (mm)	T (mm)	Weight(Kg./Mtr)	Weight(Kg./12')
1	2543	88.70	13.25	2.00	0.793	2.900-3.100

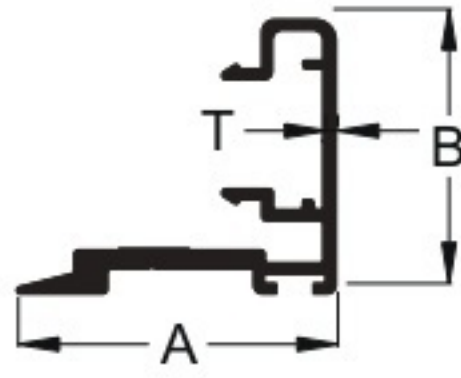

Sr. No	Section No.	A (mm)	B (mm)	T (mm)	Weight(Kg./Mtr)	Weight(Kg./12')
1	2548	39.00	33.50	1.20	0.506	1.850-2.100

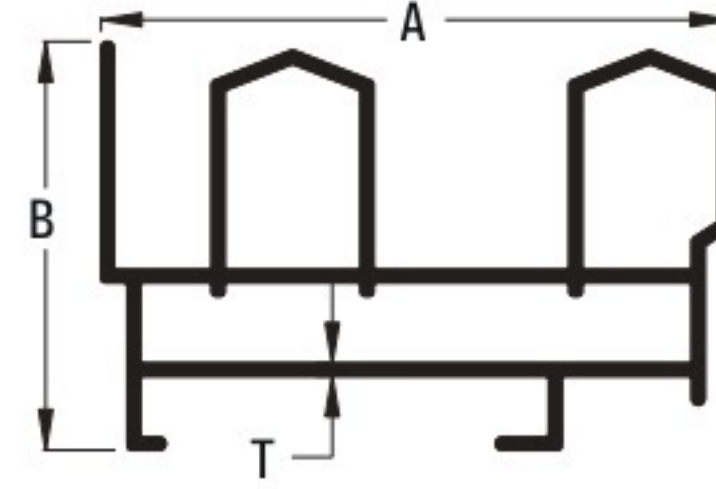

Sr. No	Section No.	A (mm)	B (mm)	T (mm)	Weight(Kg./Mtr)	Weight(Kg./12')
1	2459	74.00	48.00	1.50	1.394	5.100-5.400

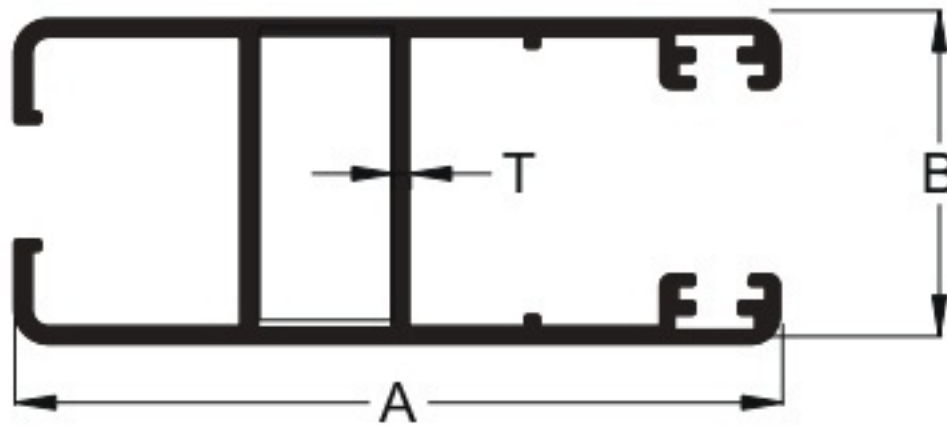

Sr. No	Section No.	A (mm)	B (mm)	T (mm)	Weight(Kg./Mtr)	Weight(Kg./12')
1	2549	66.00	28.00	1.50	0.929	3.200-3.400

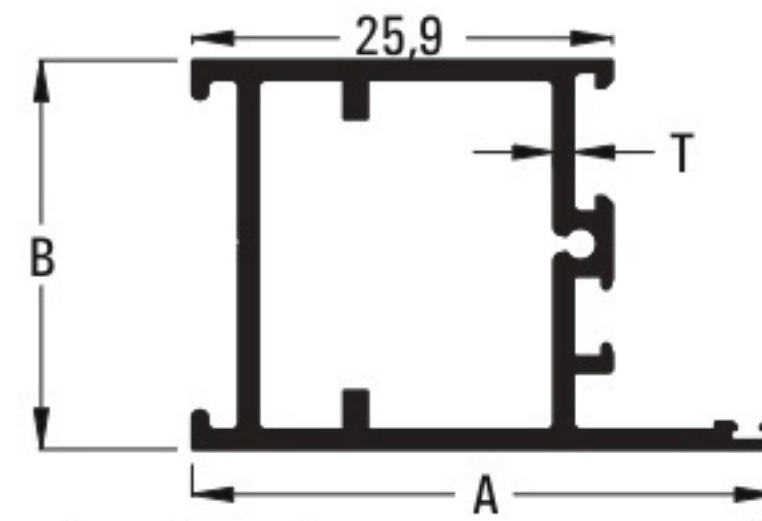

Sr. No	Section No.	A (mm)	B (mm)	T (mm)	Weight(Kg./Mtr)	Weight(Kg./12')
1	6130	36	24	2.5	1.722	6.300-6.500

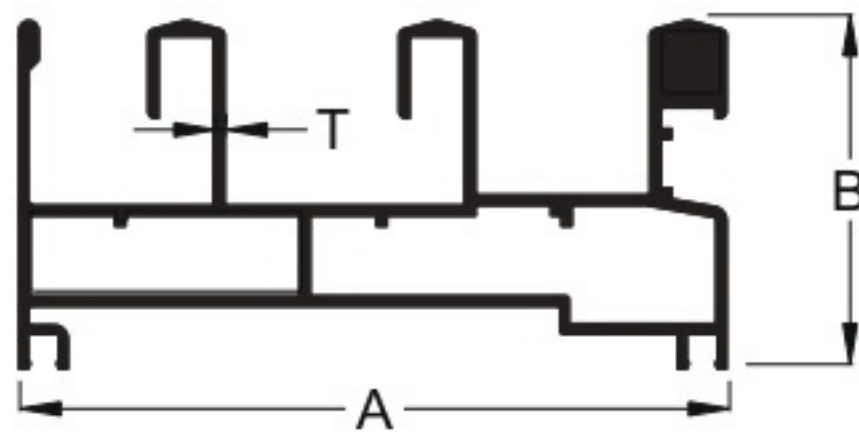

Sr. No	Section No.	A (mm)	B (mm)	T (mm)	Weight(Kg./Mtr)	Weight(Kg./12')
1	2550	101.50	50.00	1.60	1.859	6.800-7.300

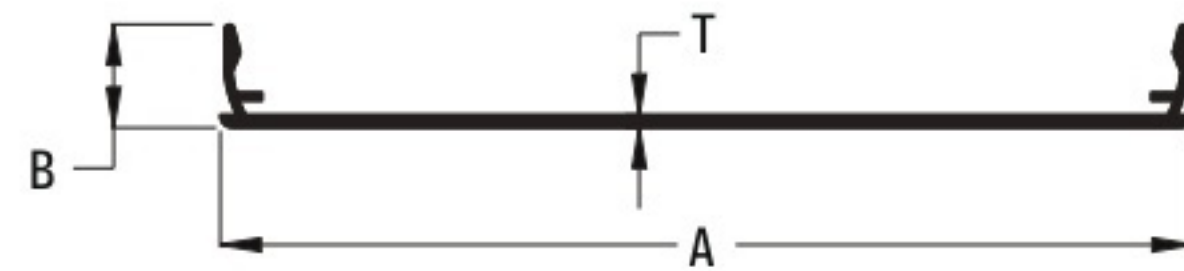

Sr. No	Section No.	A (mm)	B (mm)	T (mm)	Weight(Kg./Mtr)	Weight(Kg./12')
1	2496	120.0	12.8	1.6	0.601	2.200-2.500

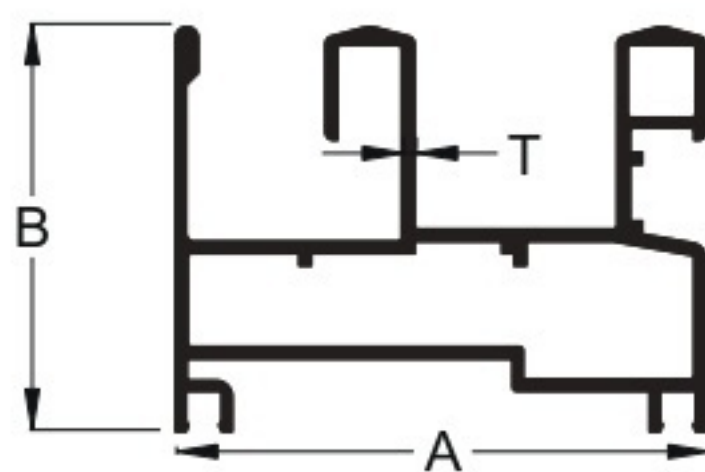

Sr. No	Section No.	A (mm)	B (mm)	T (mm)	Weight(Kg./Mtr)	Weight(Kg./12')
1	2551	65.50	50.00	1.60	1.312	4.800-5.300

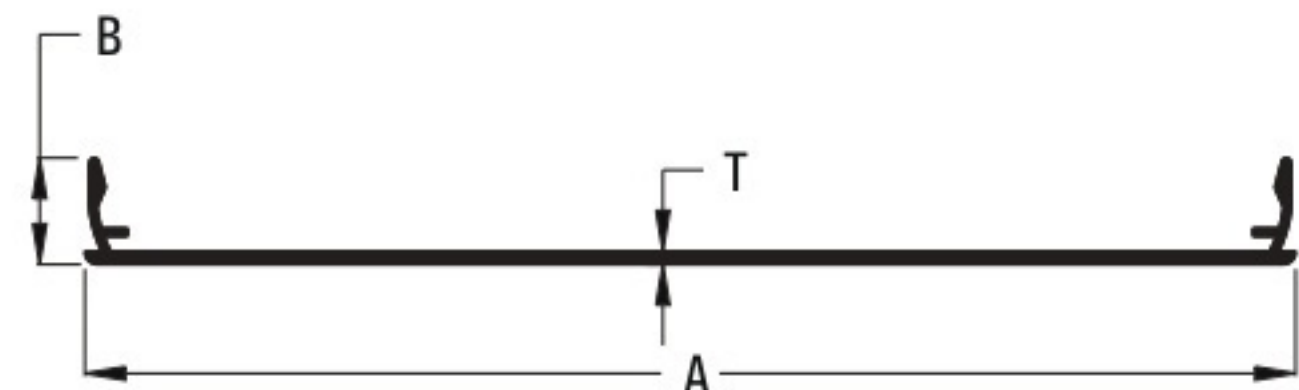

Sr. No	Section No.	A (mm)	B (mm)	T (mm)	Weight(Kg./Mtr)	Weight(Kg./12')
1	2480	149.4	13.0	1.6	0.740	2.700-2.900

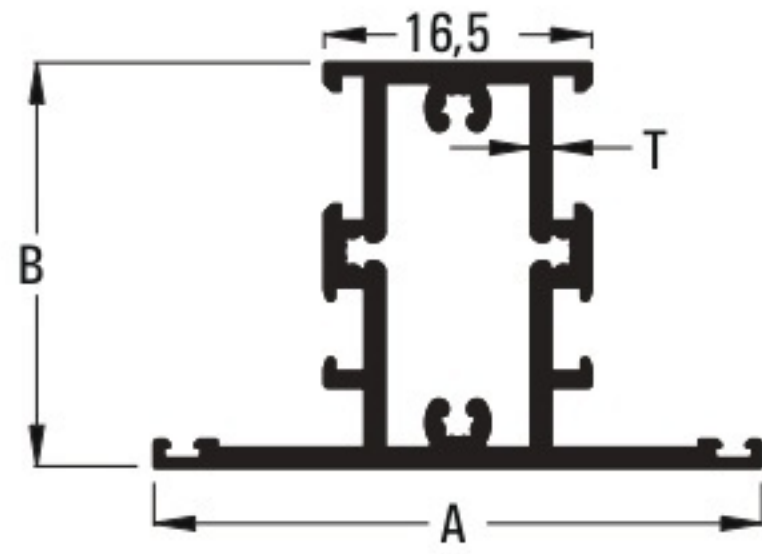

Sr. No	Section No.	A (mm)	B (mm)	T (mm)	Weight(Kg./Mtr)	Weight(Kg./12')
1	6131	37.5	24.9	2.50	1.703	6.230-6.430

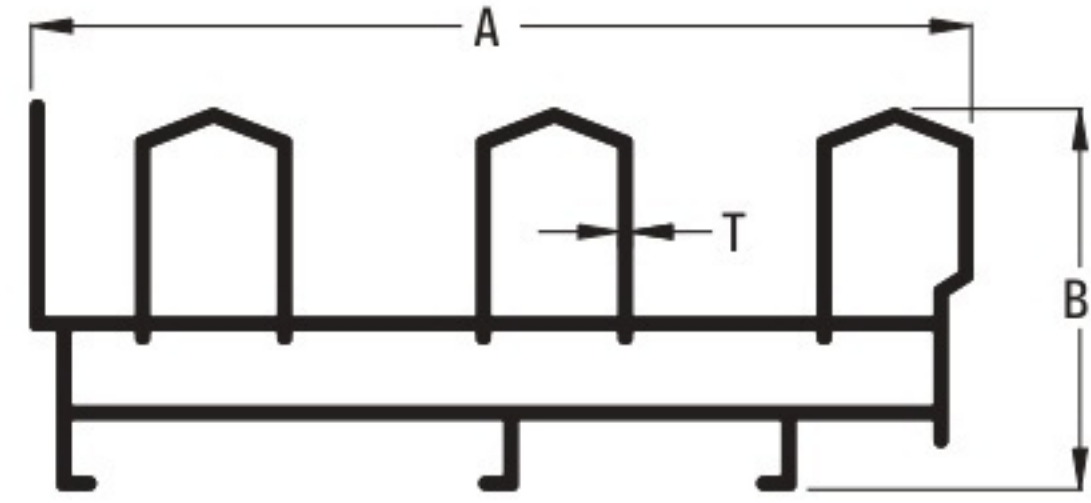

Sr. No	Section No.	A (mm)	B (mm)	T (mm)	Weight(Kg./Mtr)	Weight(Kg./12')
1	6073	116.0	47.0	1.50	2.050	7.500-7.800

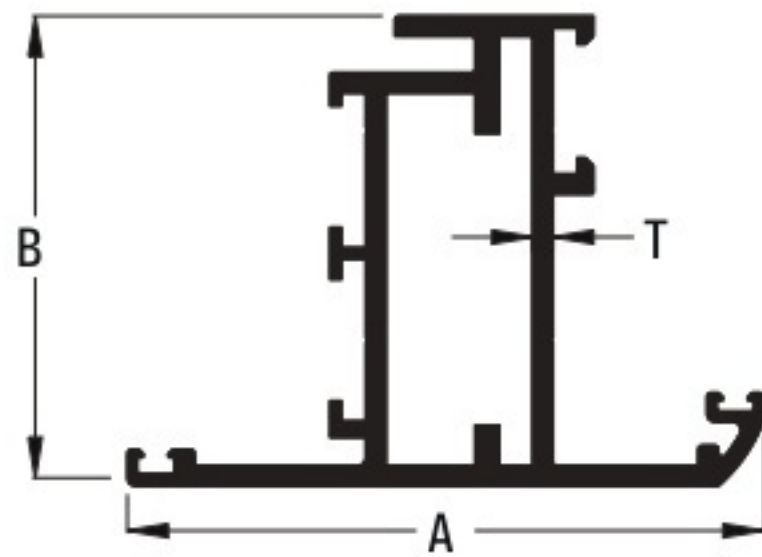

Sr. No	Section No.	A (mm)	B (mm)	T (mm)	Weight(Kg./Mtr)	Weight(Kg./12')
1	6132	39.3	28.5	2.5	1.815	6.640-6.840

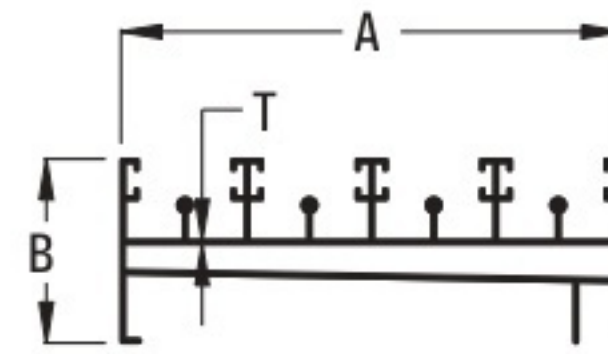

Sr. No	Section No.	A (mm)	B (mm)	T (mm)	Weight(Kg./Mtr)	Weight(Kg./12')
1	6067	123.7	45.4	1.20	1.613	5.900-6.100

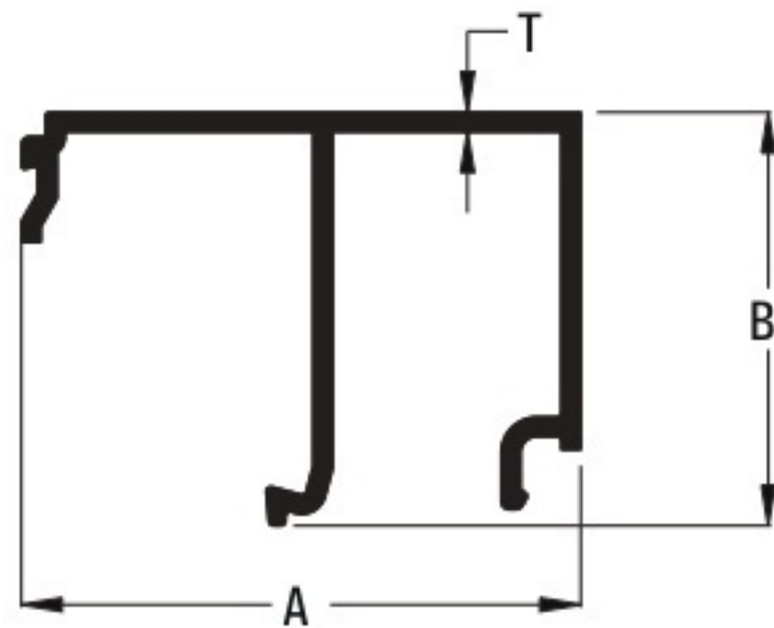

Sr. No	Section No.	A (mm)	B (mm)	T (mm)	Weight(Kg./Mtr)	Weight(Kg./12')
1	6133	34.5	25.5	1.2	0.312	1.140-1.340

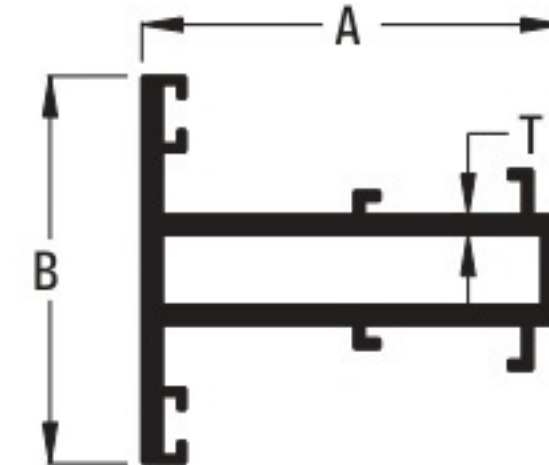

Sr. No	Section No.	A (mm)	B (mm)	T (mm)	Weight(Kg./Mtr)	Weight(Kg./12')
1	6039	61.4	56.7	3.0	1.680	6.145-6.245

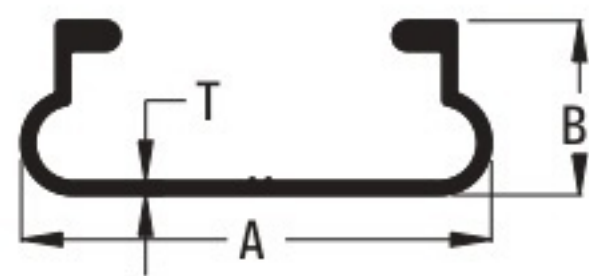

Sr. No	Section No.	A (mm)	B (mm)	T (mm)	Weight(Kg./Mtr)	Weight(Kg./12')
1	4507	29.00	10.75	0.85	0.137	0.500-0.700

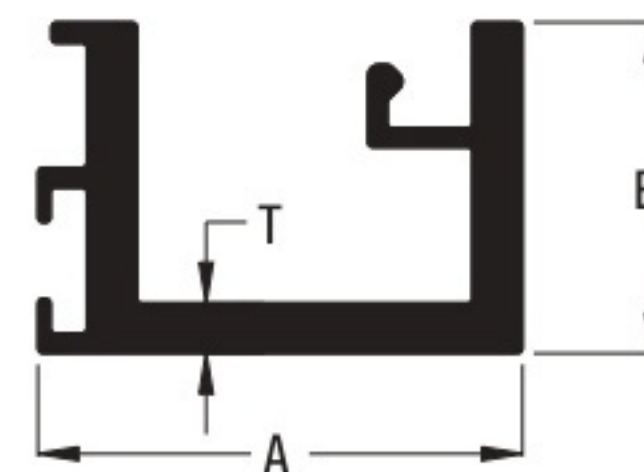

Sr. No	Section No.	A (mm)	B (mm)	T (mm)	Weight(Kg./Mtr)	Weight(Kg./12')
1	6040	29.0	19.8	3.0	0.552	2.020-2.220

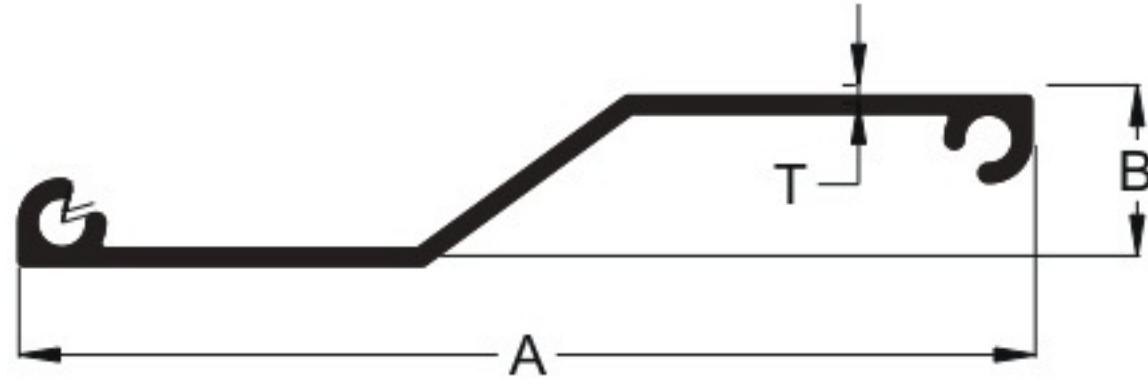

Sr. No	Section No.	A (mm)	B (mm)	T (mm)	Weight(Kg./Mtr)	Weight(Kg./12')
1	6036	62.5	10.5	1.10	0.246	0.900-1.100

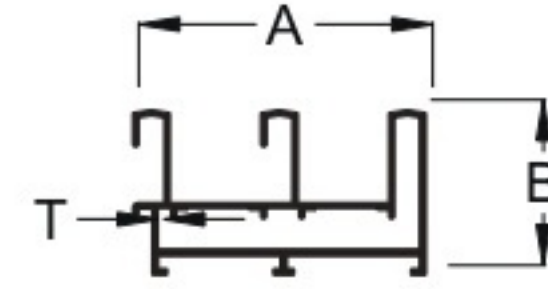

Sr. No	Section No.	A (mm)	B (mm)	T (mm)	Weight(Kg./Mtr)	Weight(Kg./12')
1	6001	79.9	45.0	1.7	1.486	5.435-5.635

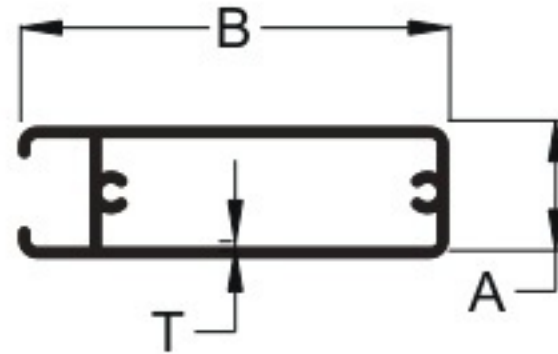

Sr. No	Section No.	A (mm)	B (mm)	T (mm)	Weight(Kg./Mtr)	Weight(Kg./12')
1	6005	18.2	60	1.3	0.592	2.165-2.365

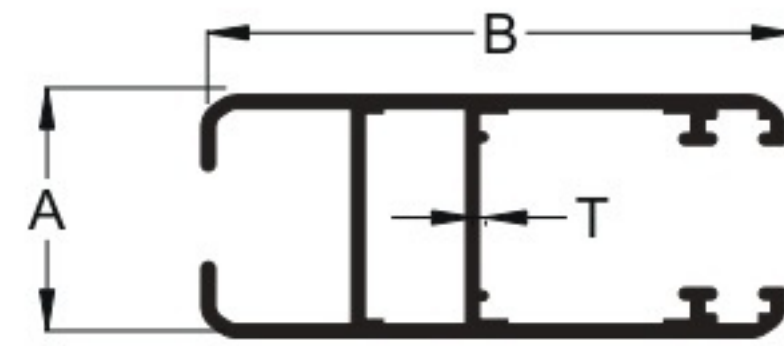

Sr. No	Section No.	A (mm)	B (mm)	T (mm)	Weight(Kg./Mtr)	Weight(Kg./12')
1	6002	27	65.1	1.5	0.858	3.140-3.340

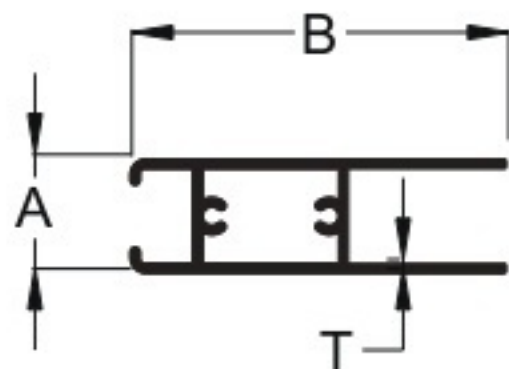

Sr. No	Section No.	A (mm)	B (mm)	T (mm)	Weight(Kg./Mtr)	Weight(Kg./12')
1	6006	18.2	60	1.3	0.683	2.500-2.700

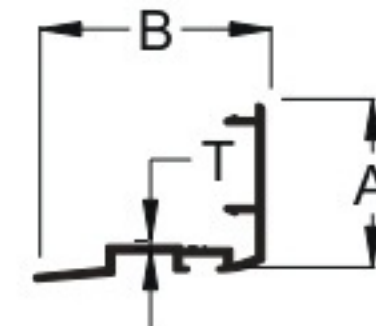

Sr. No	Section No.	A (mm)	B (mm)	T (mm)	Weight(Kg./Mtr)	Weight(Kg./12')
1	6003	28.6	38.7	1.4	0.474	1.735-1.935

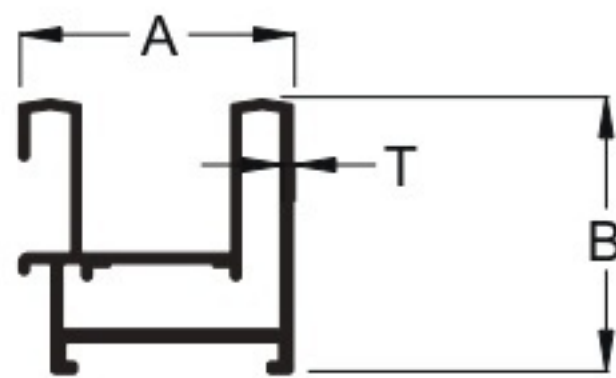

Sr. No	Section No.	A (mm)	B (mm)	T (mm)	Weight(Kg./Mtr)	Weight(Kg./12')
1	6000	45.0	45.0	2.0	1.039	3.800-4.00

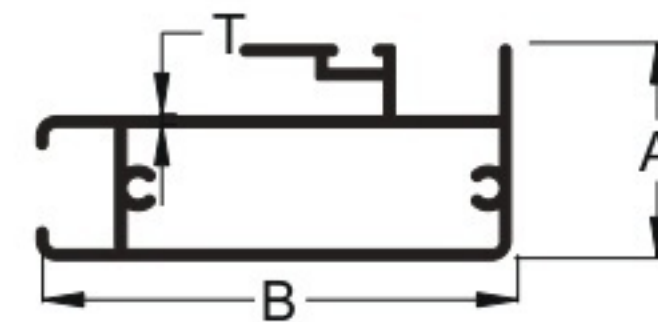

Sr. No	Section No.	A (mm)	B (mm)	T (mm)	Weight(Kg./Mtr)	Weight(Kg./12')
1	6004	27.2	60	1.3	0.738	2.710-2.910

END

OF

ARCHITACTURAL

SECTION

INDUSTRIAL SECTION

HEAT-SINK

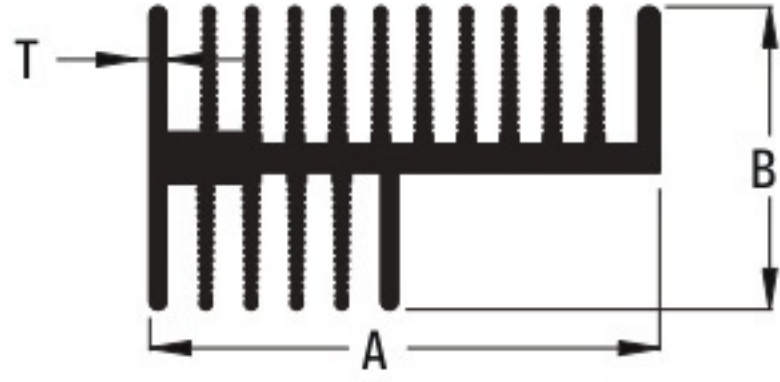

Sr. No	Section No.	A (mm)	B (mm)	T (mm)	Weight(Kg./Mtr)	Weight(Kg./12')
1	4227	57.60	34.20	1.85	1.681	6.150-6.350

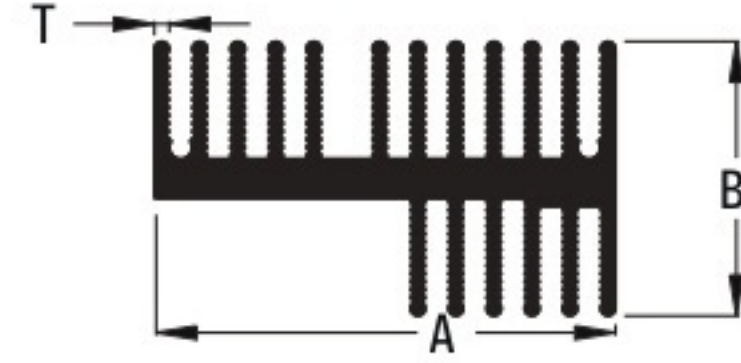

Sr. No	Section No.	A (mm)	B (mm)	T (mm)	Weight(Kg./Mtr)	Weight(Kg./12')
1	4230	58.00	34.50	1.90	1.968	7.200-7.600

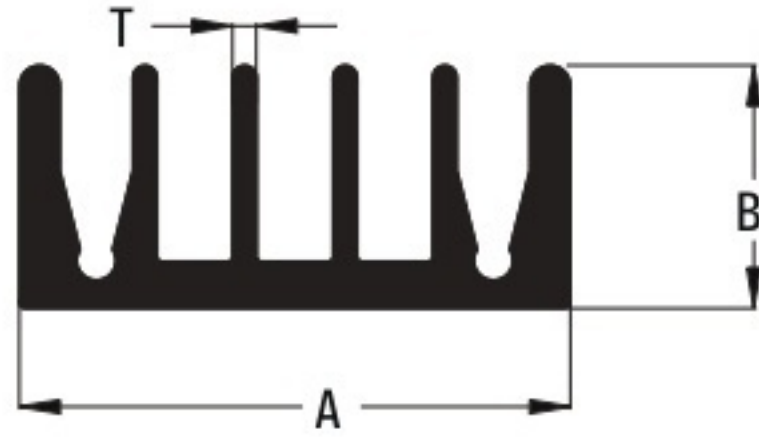

Sr. No	Section No.	A (mm)	B (mm)	T (mm)	Weight(Kg./Mtr)	Weight(Kg./12')
1	4228	34.0	15.0	1.50	0.656	2.400-2.600

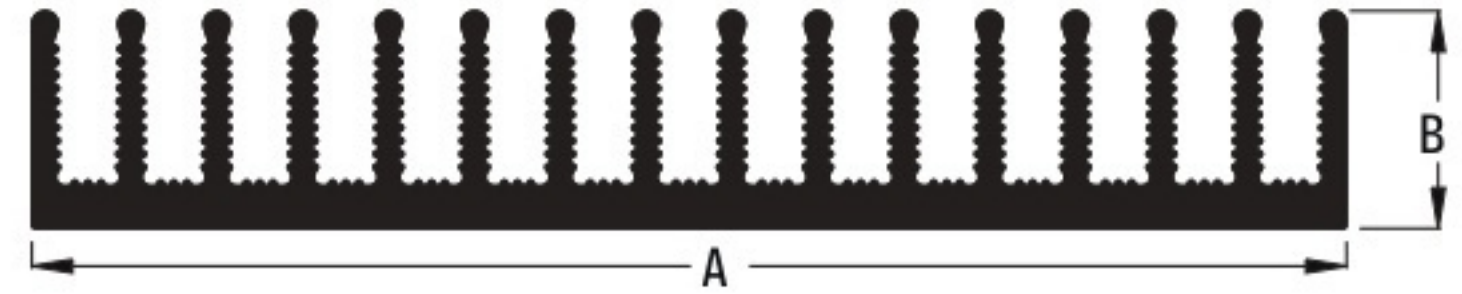

Sr. No	Section No.	A (mm)	B (mm)	Weight(Kg./Mtr)	Weight(Kg./12')
1	4224	120.0	19.80	2.734	10.00-10.300

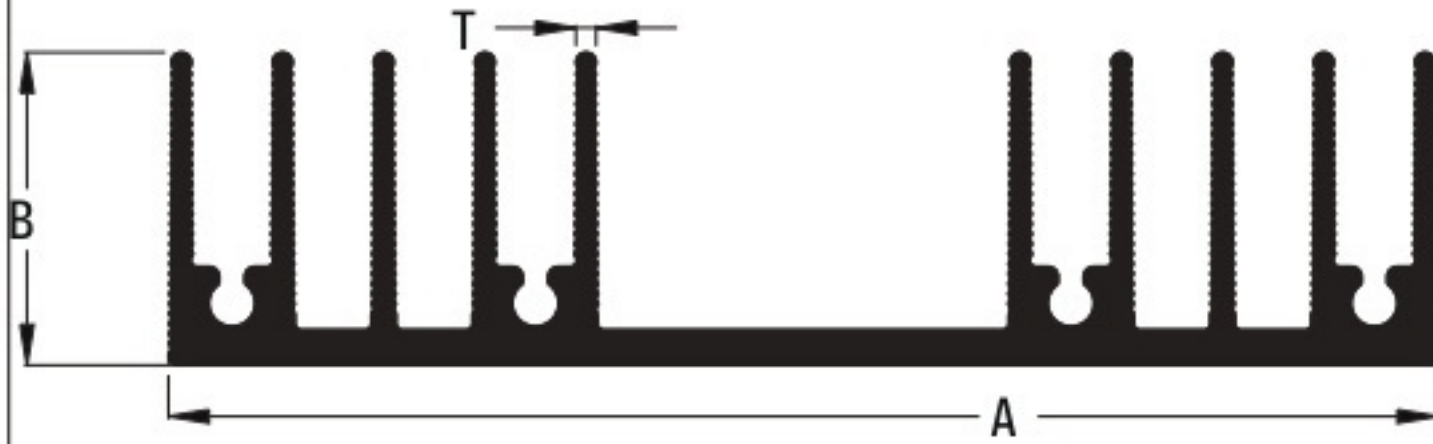

Sr. No	Section No.	A (mm)	B (mm)	T (mm)	Weight(Kg./Mtr)	Weight(Kg./12')
1	4229	100.40	24.75	1.60	1.886	6.900-7.100

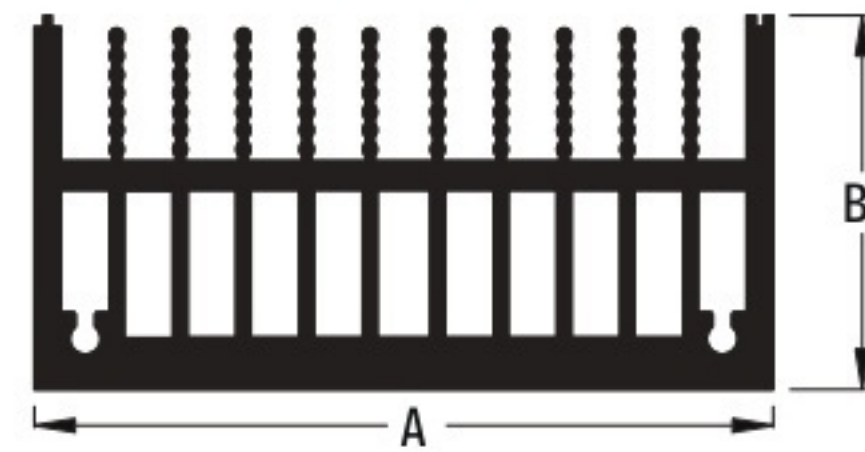

Sr. No	Section No.	A (mm)	B (mm)	Weight(Kg./Mtr)	Weight(Kg./12')
1	4222	83.50	42.30	3.828	14.00-15.00

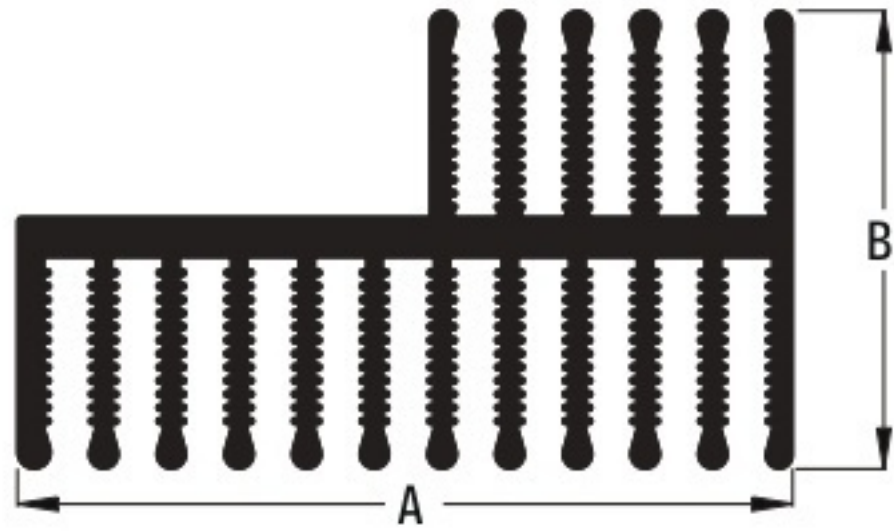

Sr. No.	Section No.	A (mm)	B (mm)	Weight(Kg./Mtr)	Weight(Kg./12')
1	4223	57.50	34.00	1.749	6.400-6.800

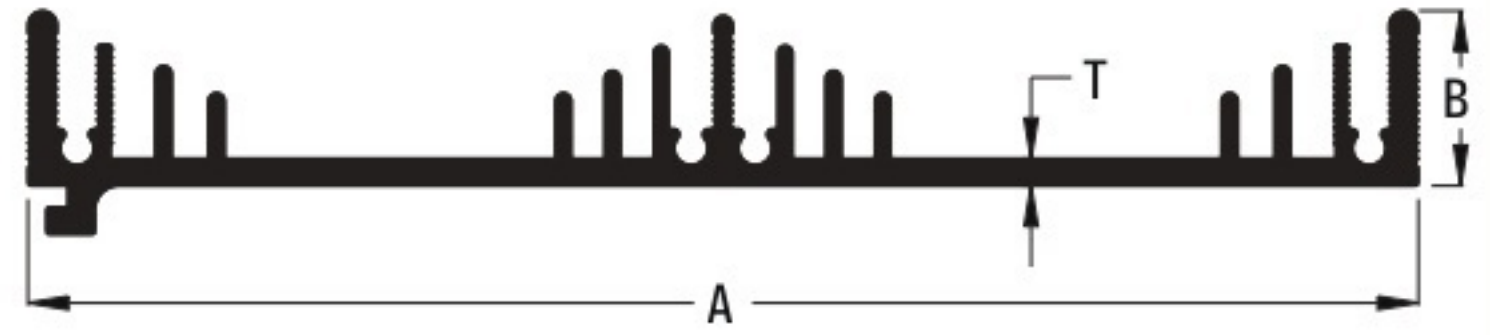

Sr. No.	Section No.	A (mm)	B (mm)	T (mm)	Weight(Kg./Mtr)	Weight(Kg./12')
1	4233	143.0	8.0	2.80	1.941	7.100-7.300

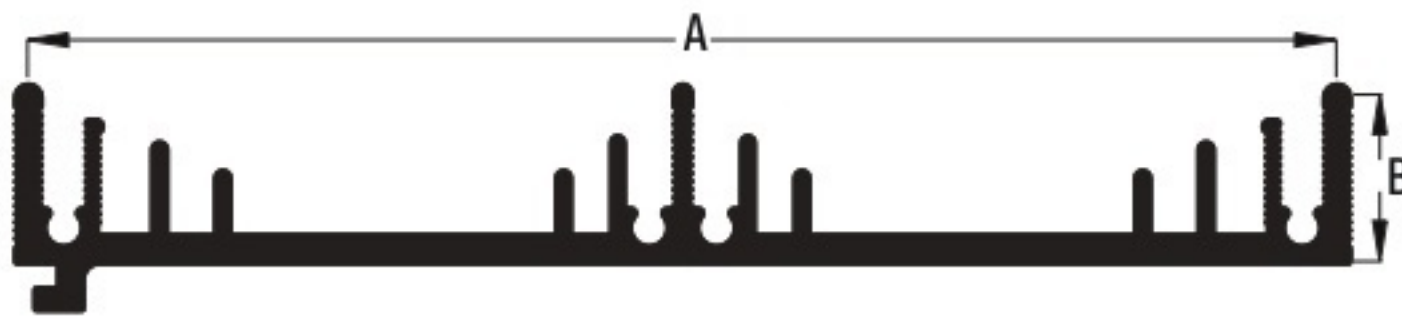

Sr. No.	Section No.	A (mm)	B (mm)	Weight(Kg./Mtr)	Weight(Kg./12')
1	4225	131.0	17.80	1.749	6.400-6.800

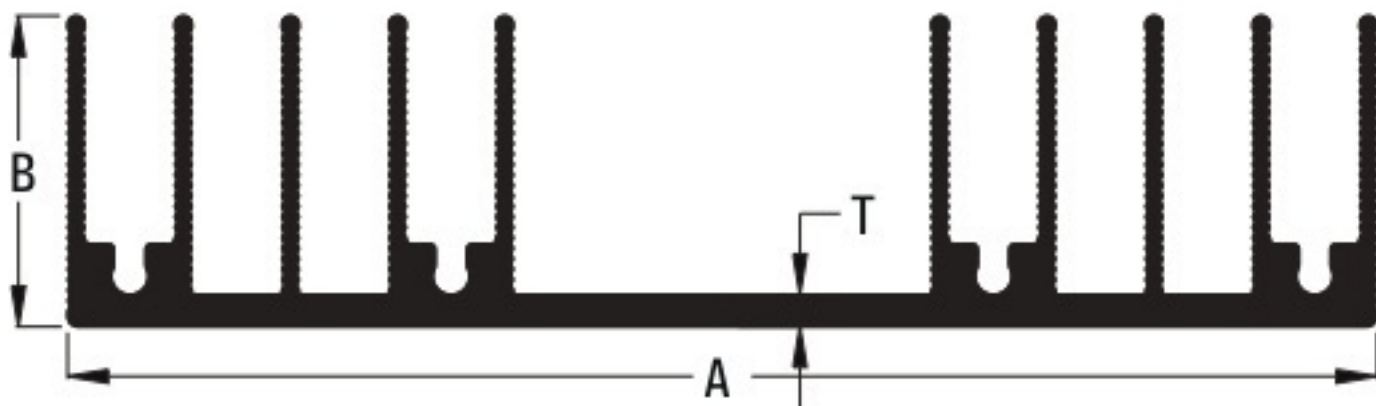

Sr. No.	Section No.	A (mm)	B (mm)	T (mm)	Weight(Kg./Mtr)	Weight(Kg./12')
1	4229	101.0	24.0	2.50	1.531	5.600-5.800



Sr. No.	Section No.	A (mm)	B (mm)	T (mm)	Weight(Kg./Mtr)	Weight(Kg./12')
1	4232	131.0	23.0	2.40	1.585	5.800-6.200

CURTAIN WALL

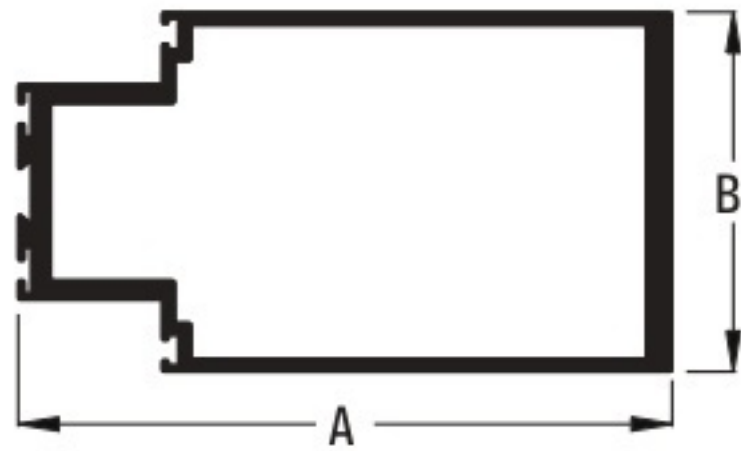

Sr. No	Section No.	A (mm)	B (mm)	T (mm)	Weight(Kg./Mtr)	Weight(Kg./12')
1	3822	100.0	55.00	-	2.159	7.900-8.500

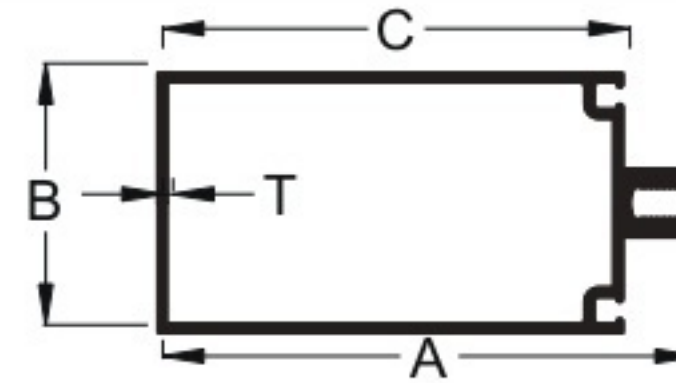

Sr. No	Section No.	A (mm)	B (mm)	C (mm)	T (mm)	Weight(Kg./Mtr)	Weight(Kg./12')
1	2541	116.20	57.00	101.80	2.20	2.241	8.200-8.600

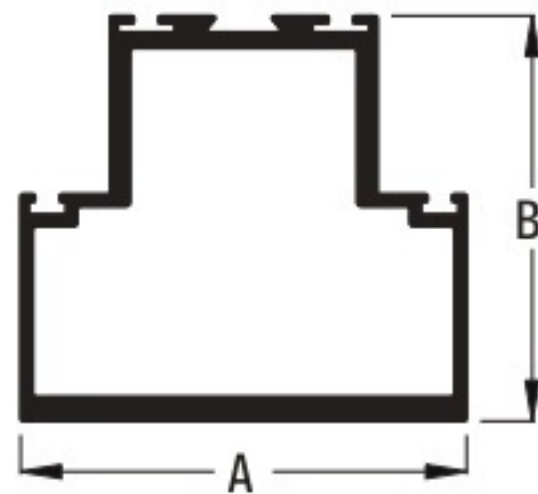

Sr. No	Section No.	A (mm)	B (mm)	T (mm)	Weight(Kg./Mtr)	Weight(Kg./12')
1	3823	55.00	50.00	-	1.257	4.600-5.200

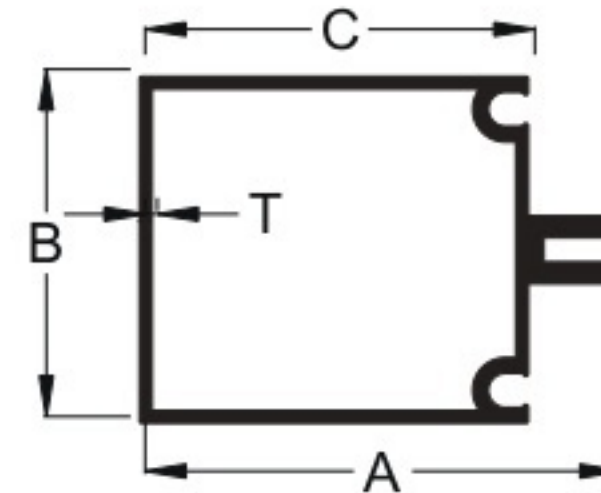

Sr. No	Section No.	A (mm)	B (mm)	C (mm)	T (mm)	Weight(Kg./Mtr)	Weight(Kg./12')
1	2542	77.10	57.00	63.15	2.00	1.586	5.800-6.200

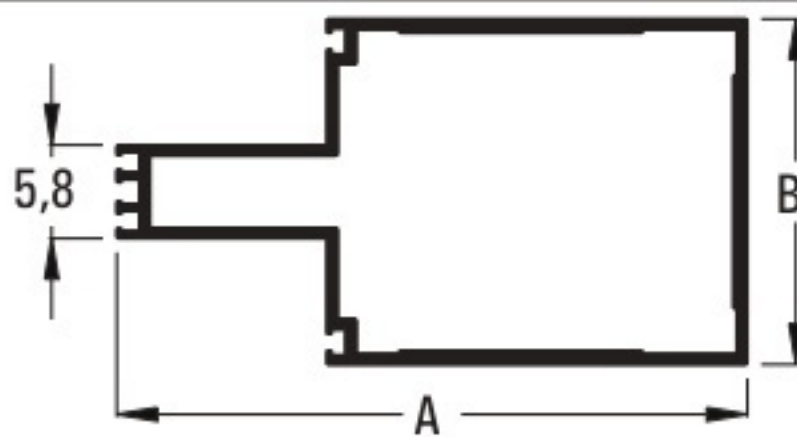

Sr. No	Section No.	A (mm)	B (mm)	T (mm)	Weight(Kg./Mtr)	Weight(Kg./12')
1	3824	135.00	74.00	-	2.898	10.600-11.100

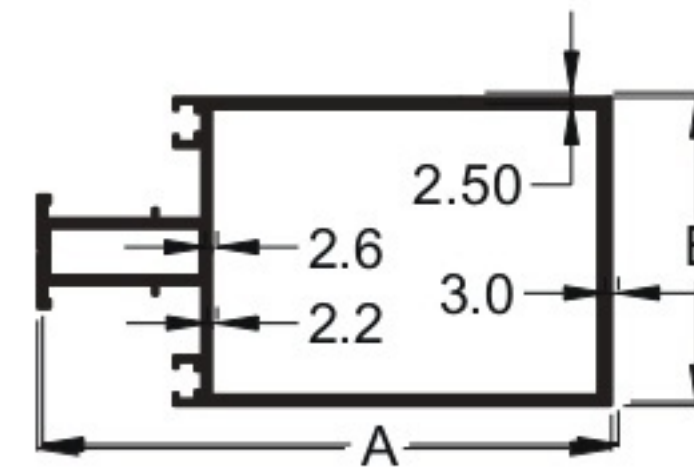

Sr. No	Section No.	A (mm)	B (mm)	T (mm)	Weight(Kg./Mtr)	Weight(Kg./12')
1	2504	131.0	70.40	-	2.966	10.850-11.050

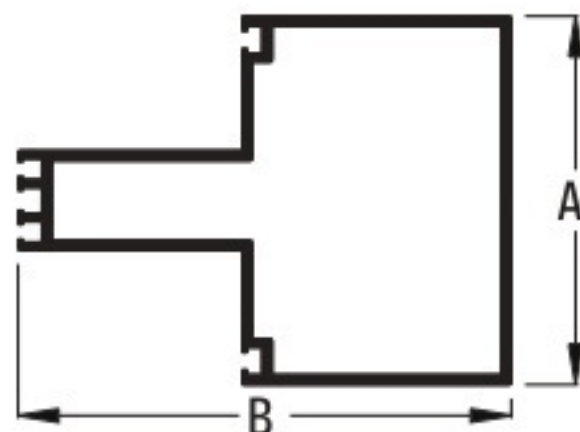

Sr. No	Section No.	A (mm)	B (mm)	T (mm)	Weight(Kg./Mtr)	Weight(Kg./12')
1	3825	74.00	99.00	2.00	1.914	7.000-7.500

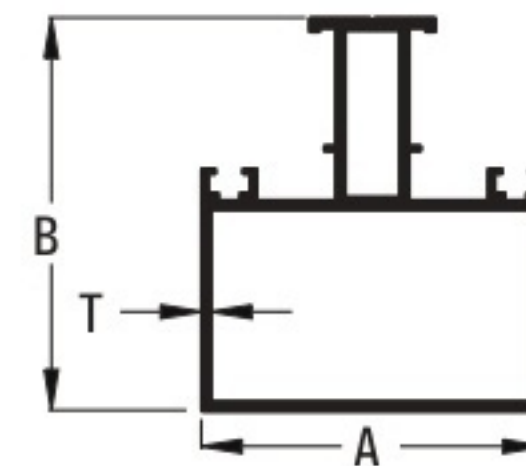

Sr. No	Section No.	A (mm)	B (mm)	T (mm)	Weight(Kg./Mtr)	Weight(Kg./12')
1	2505	70.40	81.0	2.00	1.941	7.100-7.300

TEXTILE SECTION

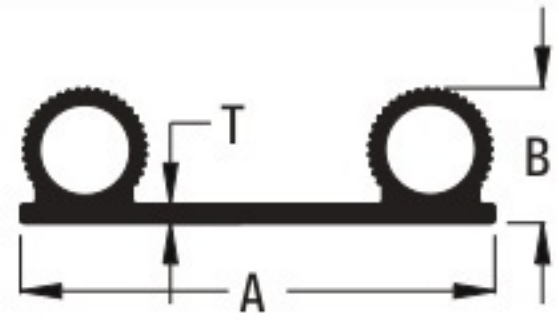

Sr. No	Section No.	A (mm)	B (mm)	T (mm)	Weight(Kg./Mtr)	Weight(Kg./12')
1	3622	45.00	12.80	1.80	0.437	1.60-1.80
2	2455	45.00	12.60	1.40	0.424	1.550-1.70



Sr. No	Section No.	A (mm)	B (mm)	T (mm)	Weight(Kg./Mtr)	Weight(Kg./12')
1	5055	55.50	12.00	1.60	0.547	2.00-2.30

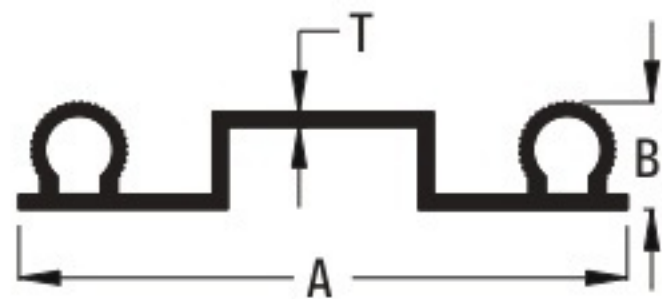

Sr. No	Section No.	A (mm)	B (mm)	T (mm)	Weight(Kg./Mtr)	Weight(Kg./12')
1	5054	75.00	13.17	1.80	0.656	2.40-2.60
2	2453	75.00	13.17	1.15	0.492	1.80-2.00
3	2453L	75.00	13.17	0.90	0.383	1.400-1.600



Sr. No	Section No.	A (mm)	B (mm)	T (mm)	Weight(Kg./Mtr)	Weight(Kg./12')
1	3937	25.00	12.50	1.70	0.219	0.80-1.00

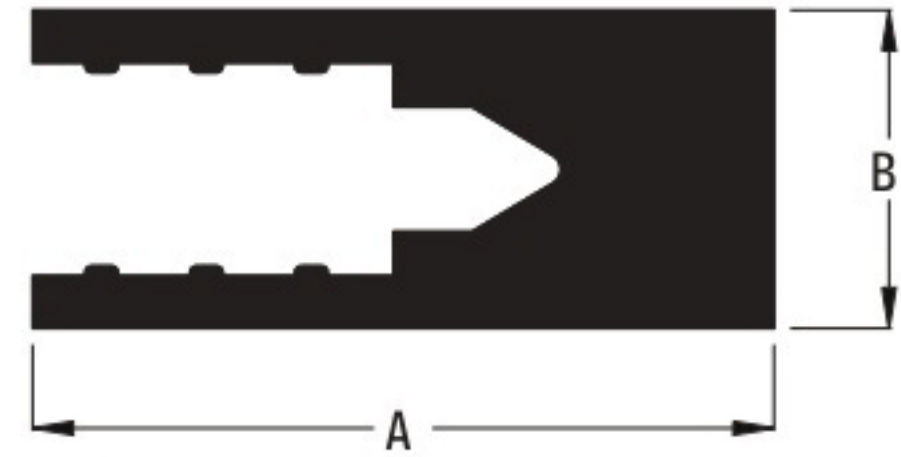

Sr. No	Section No.	A (mm)	B (mm)	Weight(Kg./Mtr)	Weight(Kg./12')
1	3621	22.60	9.70	0.355	1.30-1.40

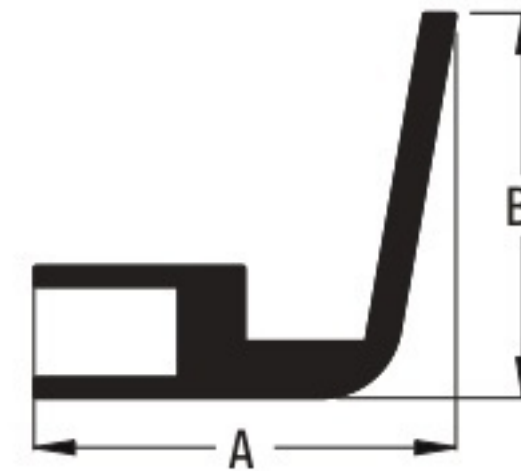

Sr. No	Section No.	A (mm)	B (mm)	Weight(Kg./Mtr)	Weight(Kg./12')
1	3624	52.00	17.15	1.367	5.00-5.50



Sr. No	Section No.	A (mm)	B (mm)	Weight(Kg./Mtr)	Weight(Kg./12')
1	3620	21.90	9.70	0.301	1.10-1.20

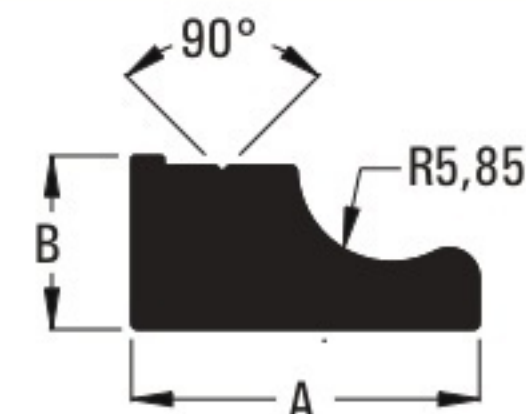

Sr. No	Section No.	A (mm)	B (mm)	Weight(Kg./Mtr)	Weight(Kg./12')
1	3932	10.70	21.50	1.410	1.50-1.70
2	3940	10.00	21.10	0.383	1.40-1.60

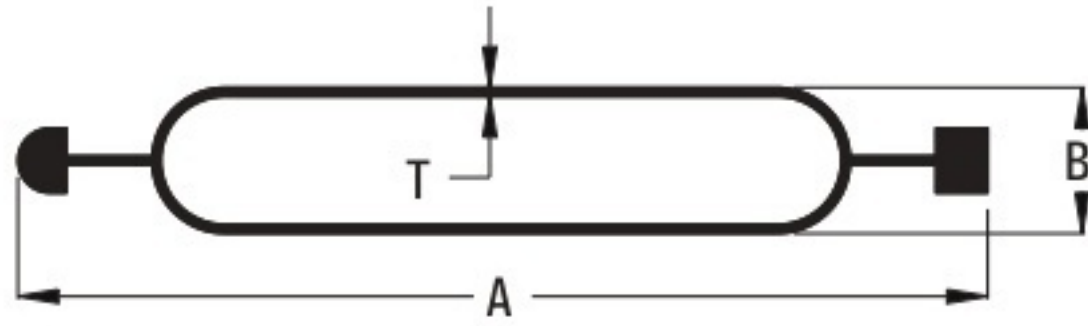

Sr. No	Section No.	A (mm)	B (mm)	T (mm)	Weight(Kg./Mtr)	Weight(Kg./12')
1	3623	46.20	8.00	0.55	0.150	0.550-0.650
2	3616	59.80	9.00	0.55	0.191	0.70-0.90
3	3617	72.00	9.00	0.90	0.383	1.40-1.60
4	3615	46.20	8.00	0.60	0.178	0.650-0.750
5	3615L	44.85	8.50	0.50	0.131	0.480-0.550

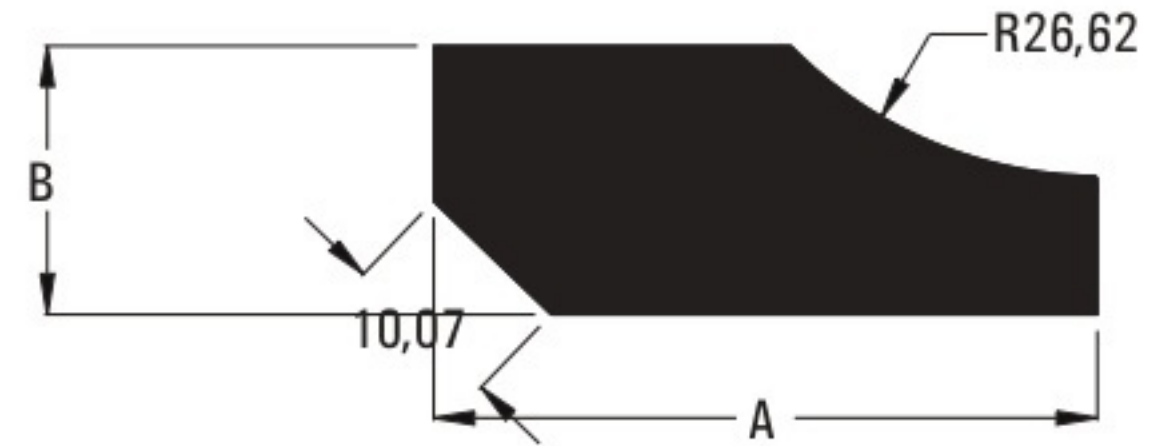

Sr. No	Section No.	A (mm)	B (mm)	Weight(Kg./Mtr)	Weight(Kg./12')
1	3931	21.60	11.00	0.711	2.60-2.80



Sr. No	Section No.	A (mm)	B (mm)	T (mm)	Weight(Kg./Mtr)	Weight(Kg./12')
1	2437	45.00	19.10	7.00	0.711	2.80-3.00



Sr. No	Section No.	A (mm)	B (mm)	T (mm)	Weight(Kg./Mtr)	Weight(Kg./12')
1	5056	59.30	9.50	1.25	0.396	1.450-1.600
2	5057	72.00	9.00	1.00	0.382	1.400-1.600
3	3618	83.90	9.00	1.40	0.629	2.300-2.600
4	3619	59.00	9.00	0.75	0.246	0.900-1.100

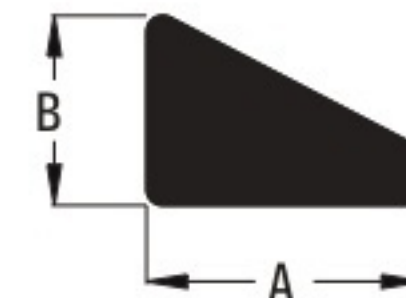

Sr. No	Section No.	A (mm)	B (mm)	Weight(Kg./Mtr)	Weight(Kg./12')
1	3932	8.50	5.85	0.090	0.330-0.450



Sr. No	Section No.	A (mm)	B (mm)	T (mm)	Weight(Kg./Mtr)	Weight(Kg./12')
1	3966	20.0	8.40	3.00	0.301	1.10-1.30



Sr. No	Section No.	A (mm)	B (mm)	T (mm)	Weight(Kg./Mtr)	Weight(Kg./12')
1	2115	90.2	9.0	1.40	0.765	2.800-3.200



Sr. No	Section No.	A (mm)	B (mm)	Weight(Kg./Mtr)	Weight(Kg./12')
1	3951	20.85	10.00	0.383	1.400-1.600

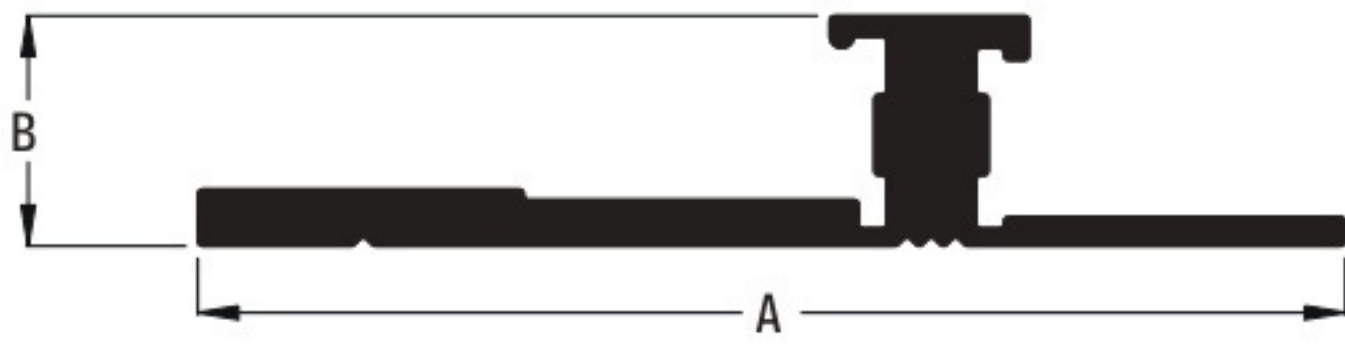

Sr. No	Section No.	A (mm)	B (mm)	T (mm)	Weight(Kg./Mtr)	Weight(Kg./12')
1	3614	70.75	14.20	-	0.711	2.600-2.900

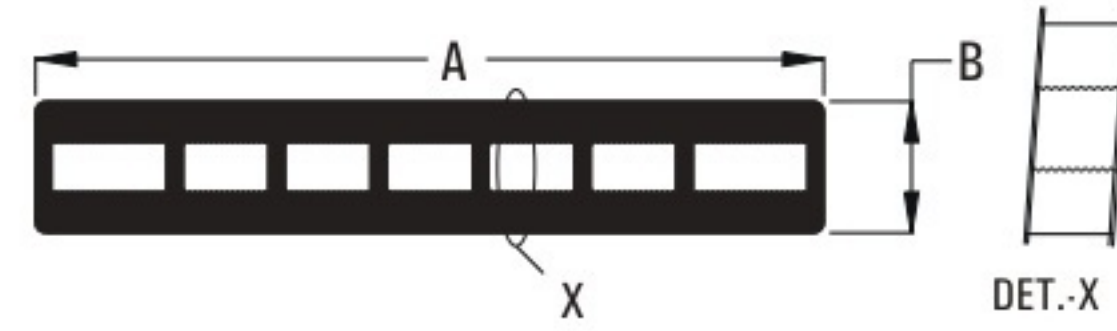

Sr. No	Section No.	A (mm)	B (mm)	T (mm)	Weight(Kg./Mtr)	Weight(Kg./Mtr.)
1	2111	150.0	25.0	...	1.865	6.820-6.840



Sr. No	Section No.	A (mm)	B (mm)	T (mm)	Weight(Kg./Mtr)	Weight(Kg./12')
1	3626	65.40	14.50	2.00	0.738	2.700-3.200

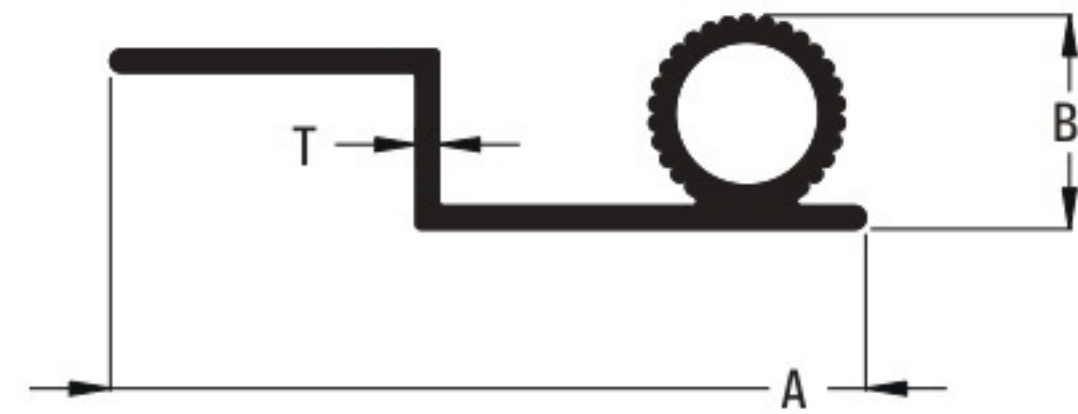

Sr. No	Section No.	A (mm)	B (mm)	T (mm)	Weight(Kg./Mtr)	Weight(Kg./12')
1	2497	46.6	13.20	1.40	0.342	1.250-1.450

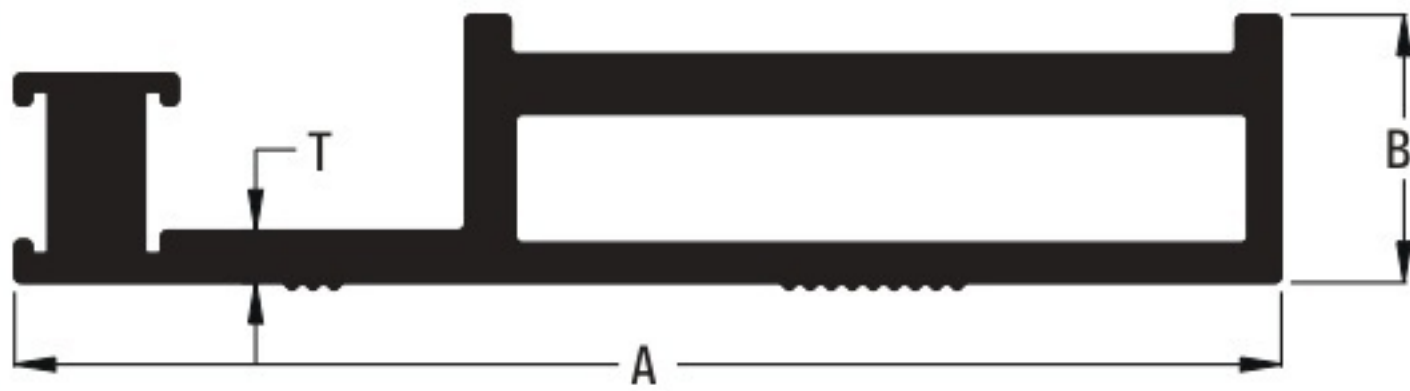

Sr. No	Section No.	A (mm)	B (mm)	T (mm)	Weight(Kg./Mtr)	Weight(Kg./12')
1	3625	90.40	19.10	3.70	1.859	6.800-7.300

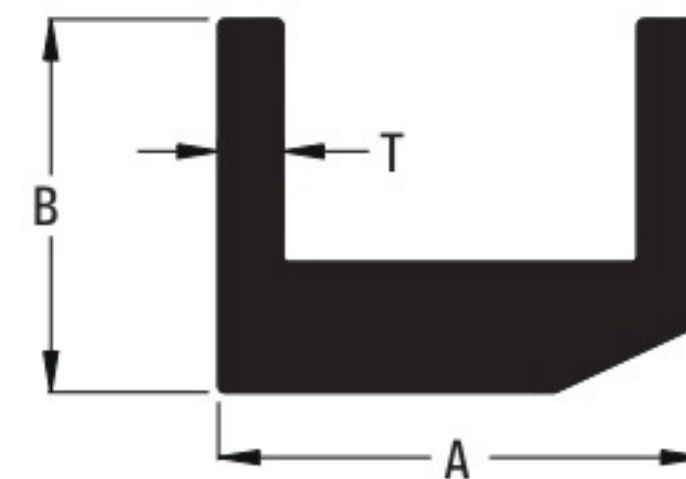

Sr. No	Section No.	A (mm)	B (mm)	T (mm)	Weight(Kg./Mtr)	Weight(Kg./12')
1	3776	36.80	28.40	4.90	1.394	5.100-5.400



Sr. No	Section No.	A (mm)	B (mm)	T (mm)	Weight(Kg./Mtr)	Weight(Kg./12')
1	3629	83.00	7.50	1.80	0.820	3.00-3.400

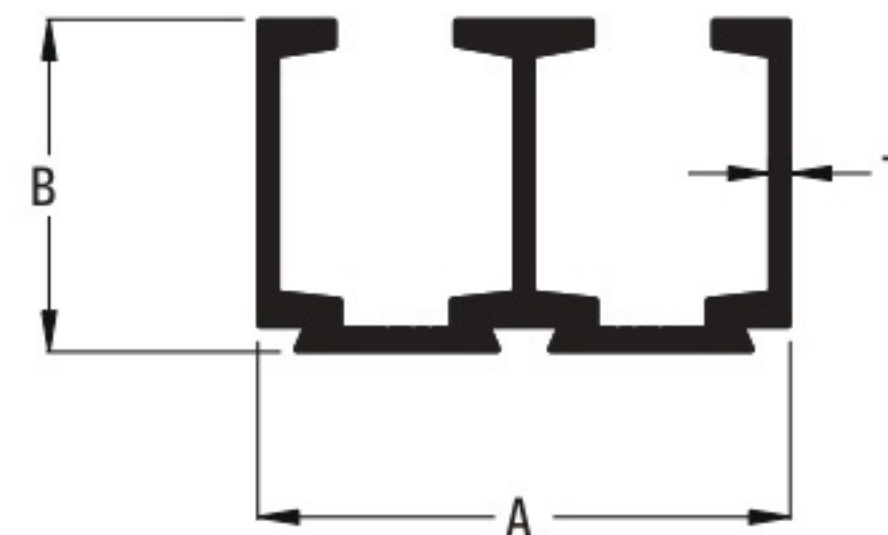

Sr. No	Section No.	A (mm)	B (mm)	T (mm)	Weight(Kg./Mtr)	Weight(Kg./12')
1	6153	65.65	38.0	2.60	1.681	6.150-6.350

CARRIER SECTION

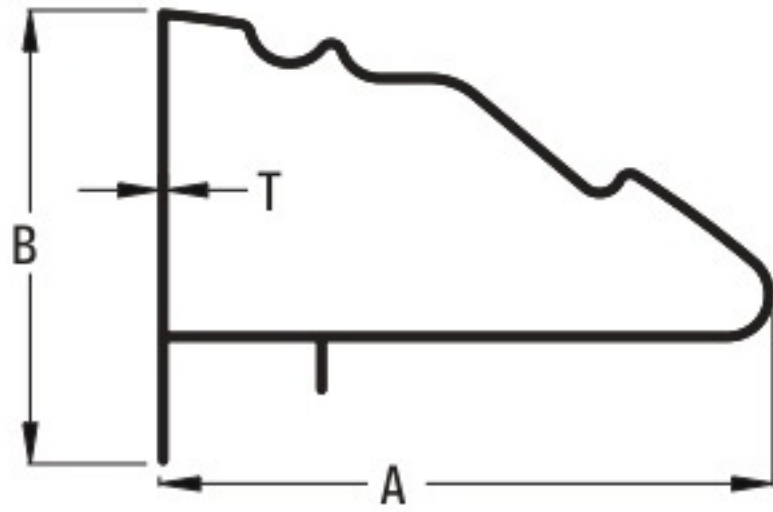

Sr. No	Section No.	A (mm)	B (mm)	T (mm)	Weight(Kg./Mtr)	Weight(Kg./12')
1	3948	82.10	60.70	1.00	0.669	2.450-2.750

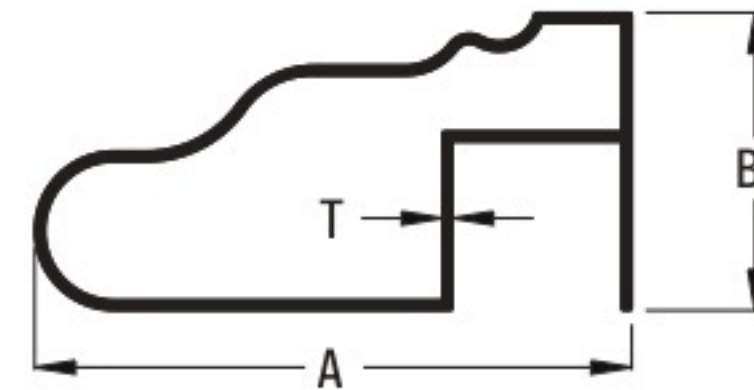

Sr. No	Section No.	A (mm)	B (mm)	T (mm)	Weight(Kg./Mtr)	Weight(Kg./12')
1	3963	75.00	37.40	1.30	0.780	2.850-3.200

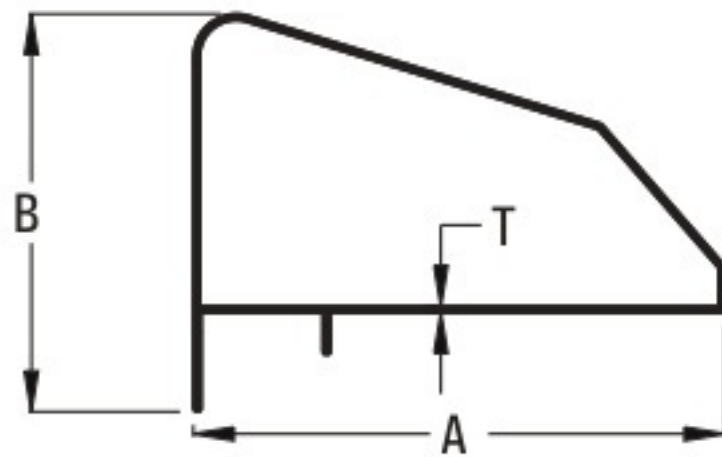

Sr. No	Section No.	A (mm)	B (mm)	T (mm)	Weight(Kg./Mtr)	Weight(Kg./12')
1	3953	88.70	66.38	1.10	0.820	3.00-3.400

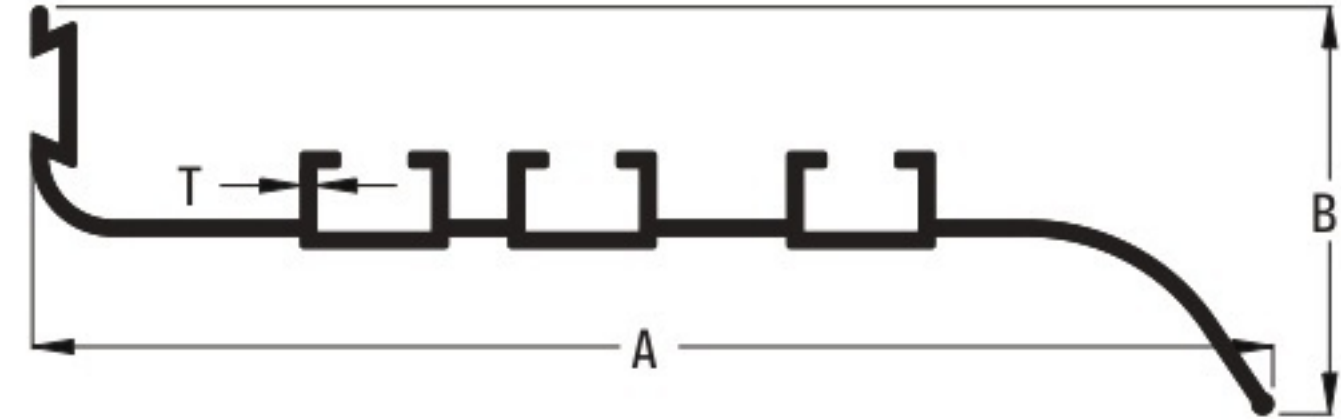

Sr. No	Section No.	A (mm)	B (mm)	T (mm)	Weight(Kg./Mtr)	Weight(Kg./12')
1	3962	152.71	50.11	1.80	1.326	4.850-5.200

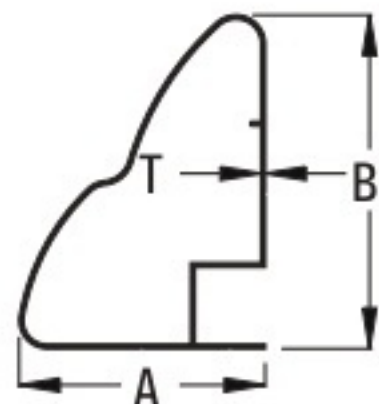

Sr. No	Section No.	A (mm)	B (mm)	T (mm)	Weight(Kg./Mtr)	Weight(Kg./12')
1	3964	70.00	95.00	1.20	1.011	3.700-4.200

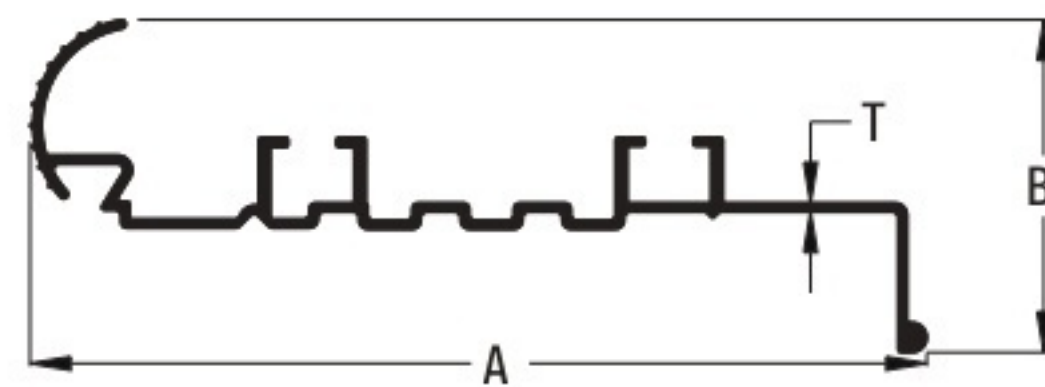

Sr. No	Section No.	A (mm)	B (mm)	T (mm)	Weight(Kg./Mtr)	Weight(Kg./12')
1	3947	150.0	55.65	1.50	1.299	4.750-5.200

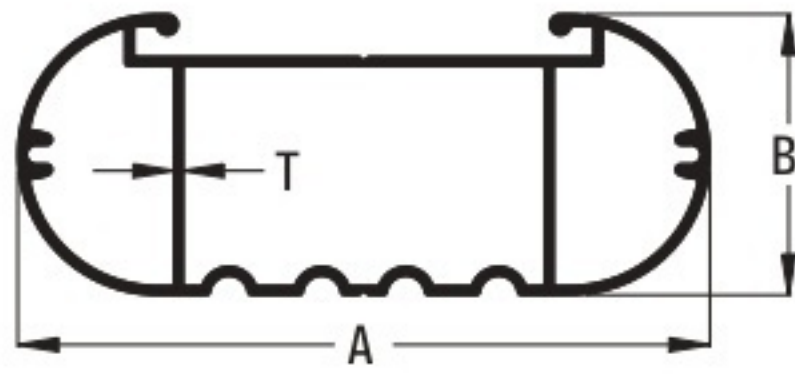

Sr. No	Section No.	A (mm)	B (mm)	T (mm)	Weight(Kg./Mtr)	Weight(Kg./12')
1	3942	98.80	40.10	1.30	1.258	4.600-5.100

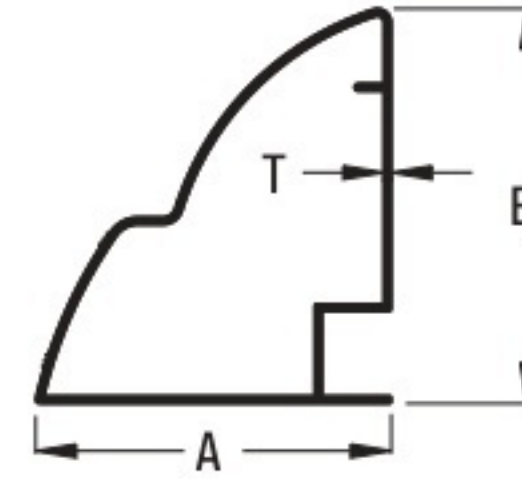

Sr. No	Section No.	A (mm)	B (mm)	T (mm)	Weight(Kg./Mtr)	Weight(Kg./12')
1	3933	84.87	94.28	1.40	1.285	4.700-5.100

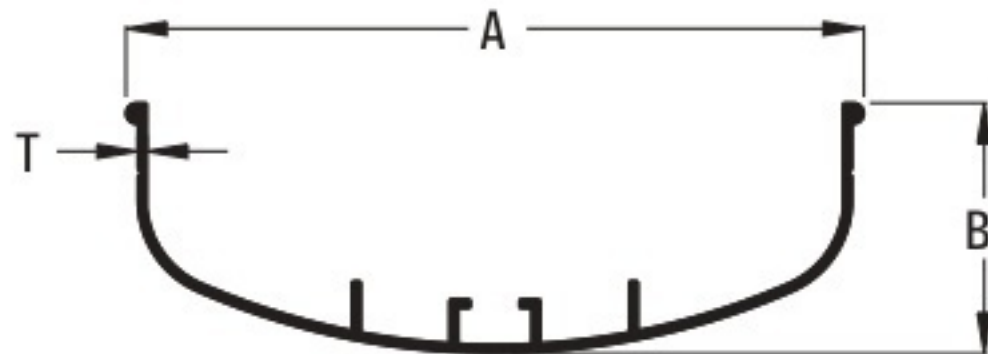

Sr. No	Section No.	A (mm)	B (mm)	T (mm)	Weight(Kg./Mtr)	Weight(Kg./12')
1	3965	106.00	36.00	1.30	0.601	2.200-2.600

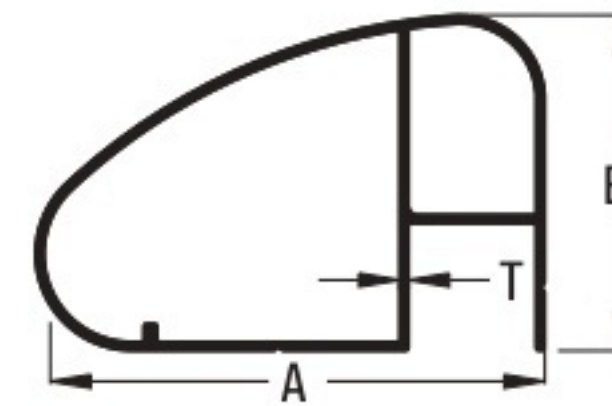

Sr. No	Section No.	A (mm)	B (mm)	T (mm)	Weight(Kg./Mtr)	Weight(Kg./12')
1	3941	84.20	55.50	1.50	1.175	4.300-4.800

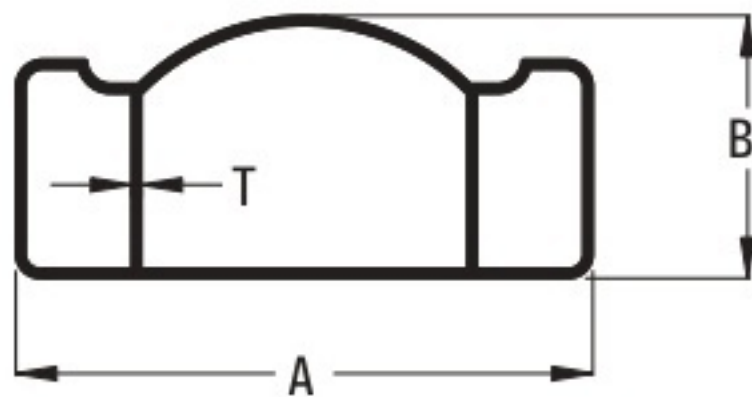

Sr. No	Section No.	A (mm)	B (mm)	T (mm)	Weight(Kg./Mtr)	Weight(Kg./12')
1	3934	118.60	54.00	2.00	2.105	7.70-8.20

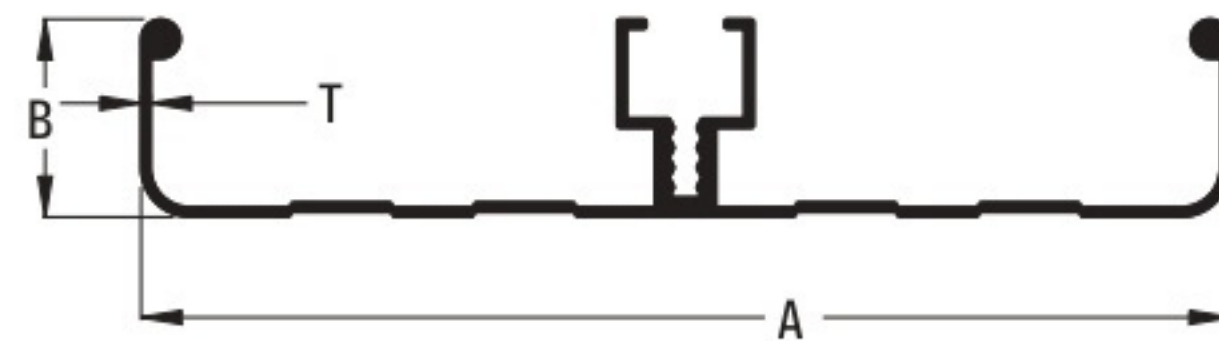

Sr. No	Section No.	A (mm)	B (mm)	T (mm)	Weight(Kg./Mtr)	Weight(Kg./12')
1	3967	110.0	20.0	1.00	0.615	2.250-2.500

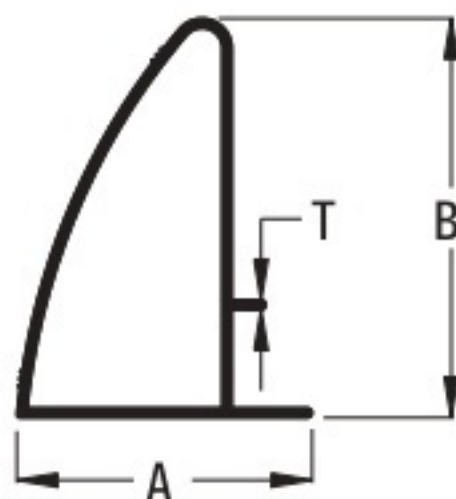

Sr. No	Section No.	A (mm)	B (mm)	T (mm)	Weight(Kg./Mtr)	Weight(Kg./12')
1	3935	60.70	82.10	2.00	1.285	4.70-5.00

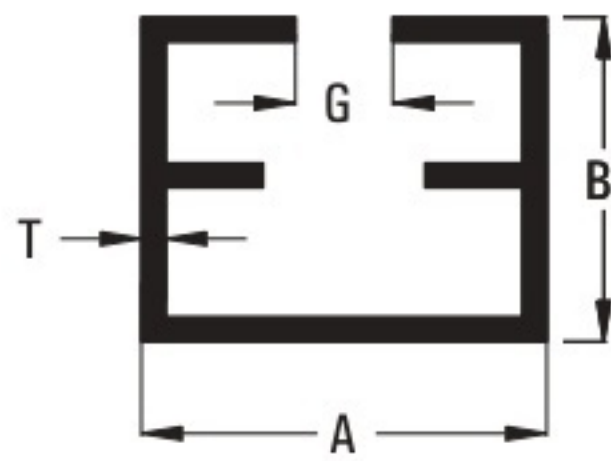

Sr. No	Section No.	A (mm)	B (mm)	G (mm)	T (mm)	Weight(Kg./Mtr)	Weight(Kg./12')
1	3929	40.00	40.00	11.80	2.40	0.998	3.65-4.00
2	3924	50.00	40.00	3.00	5.35	1.463	5.35-5.20

EYE-GLASS

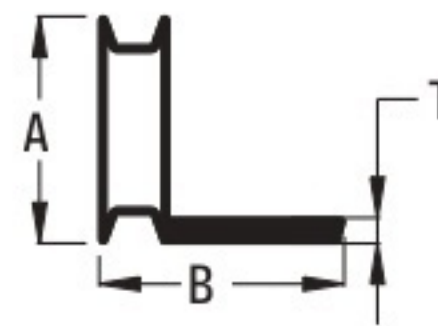

(2461)

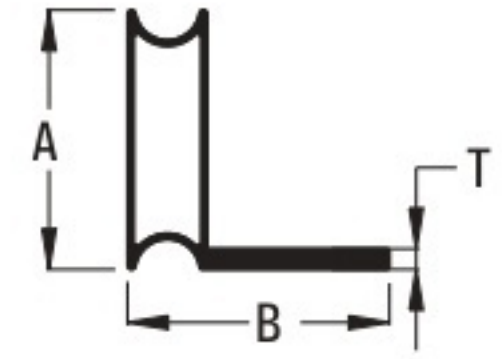

(2462)

Sr. No	Section No.	A (mm)	B (mm)	T (mm)	Weight(Kg./Mtr)	Weight(Kg./12')
1	2461	28.00	32.25	3.15	0.355	1.300-1.500
2	2462	32.00	32.30	2.55	0.328	1.200-1.400



Sr. No	Section No.	A (mm)	B (mm)	T (mm)	Weight(Kg./Mtr)	Weight(Kg./12')
1	3930	64.00	9.00	3.05	1.017	3.720-3.920

Roller

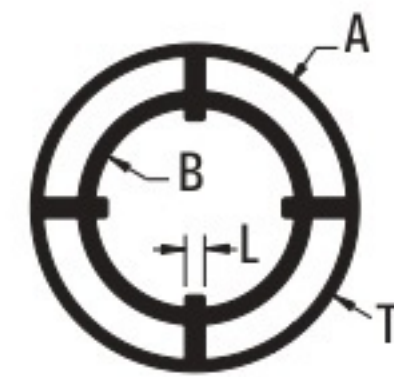

Sr. No	Section No.	A (mm)	B (mm)	L (mm)	T (mm)	Weight(Kg./Mtr)	Weight(Kg./12')
1	3957	50.5	31.0	3.0	1.80	1.668	6.100-6.600

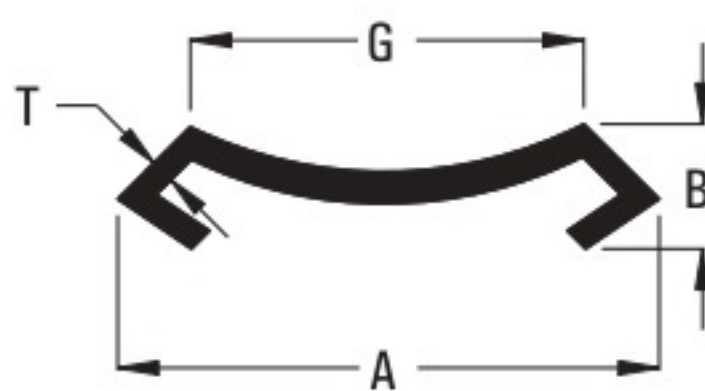

Sr. No	Section No.	A (mm)	B (mm)	G (mm)	T (mm)	Weight(Kg./Mtr)	Weight(Kg./12')
1	3925	21.00	7.88	13.47	1.30	0.109	0.40-0.50

Tower Bolt

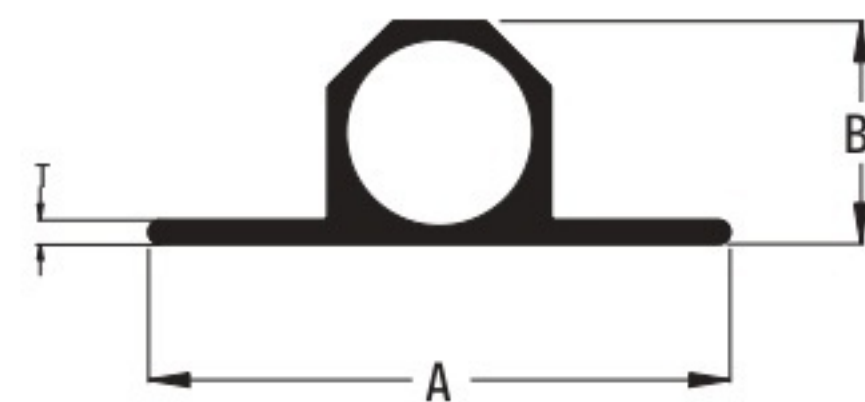

Sr. No	Section No.	A (mm)	B (mm)	T (mm)	Weight(Kg./Mtr)	Weight(Kg./12')
1	1700	34.50	12.30	1.00	0.172	0.630-0.830
2	1701	29.90	10.50	0.70	0.117	0.430-0.630
3	1702	13.80	13.80	1.25	0.198	0.725-0.925
4	1703	34.00	12.00	0.60	0.131	0.480-0.550
5	1704	38.00	15.20	1.80	0.355	1.300-1.400
6	1705	35.85	13.70	1.45	0.273	1.000-1.100
7	1706	35.50	12.80	0.85	0.178	0.650-0.700
8	1707	36.50	15.20	2.10	0.355	1.300-1.400
9	1709	38.60	13.20	1.30	0.246	0.900-1.000
10	1710	35.0	12.55	0.80	0.160	0.600-0.700
11	1711	34.50	12.55	0.80	0.160	0.600-0.700
12	1712	36.00	14.60	1.80	0.290	1.075-1.200
13	1713	29.30	10.90	0.65	0.125	0.460-0.560
14	1714	23.00	9.90	0.65	0.100	0.370-0.450

GEAR BODY

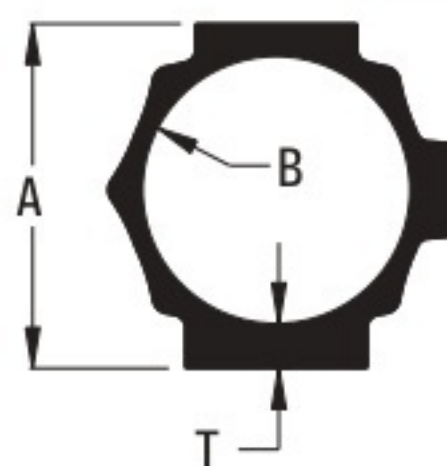

Sr. No	Section No.	A (mm)	B (mm)	T (mm)	Weight(Kg./Mtr)	Weight(Kg./12')
1	1728	170.0	132.0	22.0	21.300	77.906-78.306

BOARD SECTION

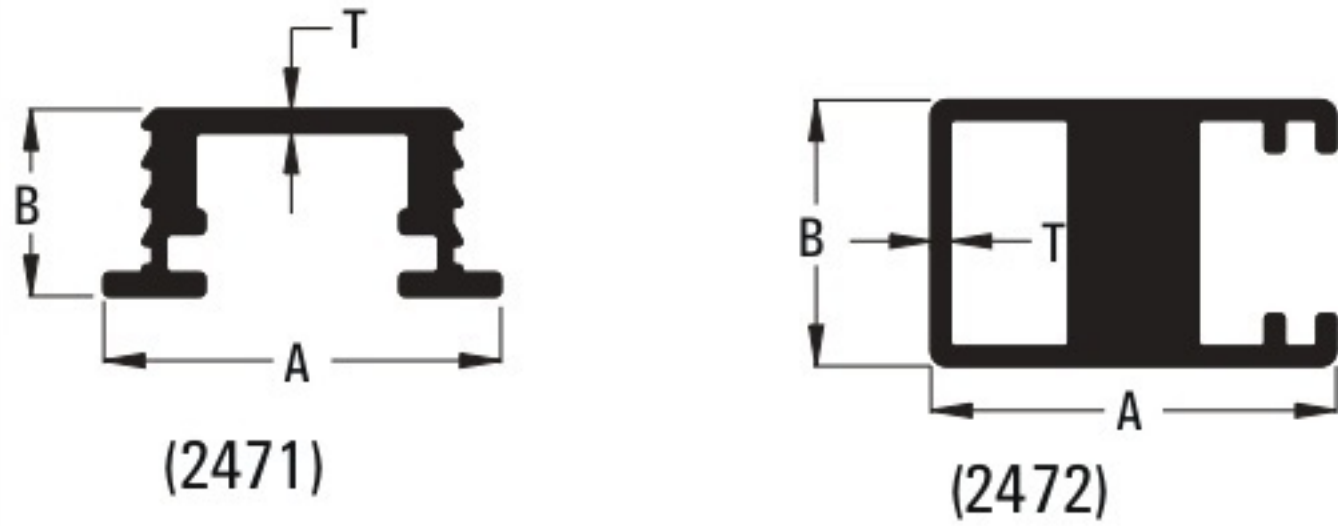

Sr. No	Section No.	A (mm)	B (mm)	T (mm)	Weight(Kg./Mtr)	Weight(Kg./12')
1	2471	20.40	9.60	1.20	0.164	0.600-0.800
2	2472	25.00	16.40	1.20	0.534	1.955-2.400

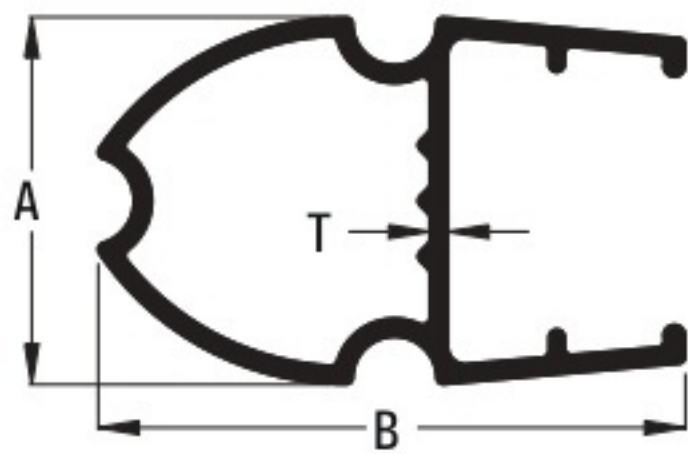

Sr. No	Section No.	A (mm)	B (mm)	T (mm)	Weight(Kg./Mtr)	Weight(Kg./12')
1	3943	15.74	25.16	0.80	0.164	0.600-0.900

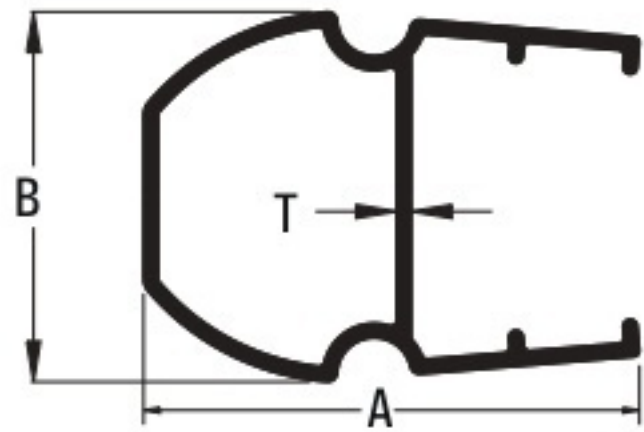

Sr. No	Section No.	A (mm)	B (mm)	T (mm)	Weight(Kg./Mtr)	Weight(Kg./12')
1	3956	25.50	19.0	0.75	0.176	0.645-0.850

MARUTI LOCK

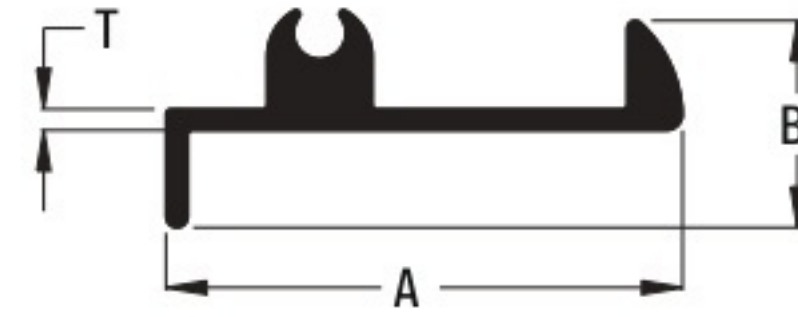

Sr. No	Section No.	A (mm)	B (mm)	T (mm)	Weight(Kg./Mtr)	Weight(Kg./12')
1	2396	31.85	13.80	1.30	0.246	0.900-1.100

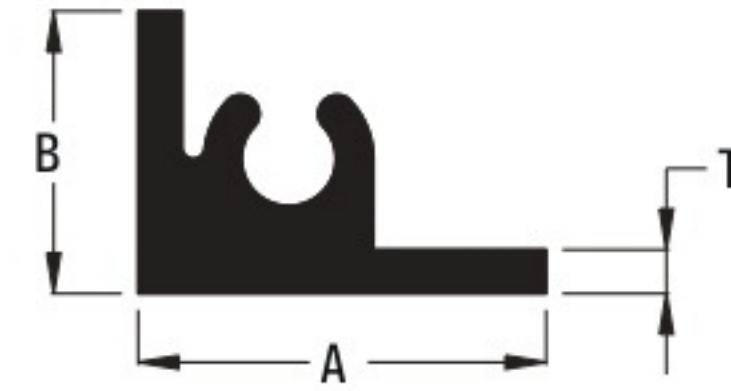

Sr. No	Section No.	A (mm)	B (mm)	T (mm)	Weight(Kg./Mtr)	Weight(Kg./12')
1	2397	13.00	9.00	1.40	0.130	0.475-0.675

Bus Body



Sr. No	Section No.	A (mm)	B (mm)	T (mm)	Weight(Kg./Mtr)	Weight(Kg./12')
1	4124	29.70	11.30	1.30	0.273	1.000-1.200

Bulb Tee

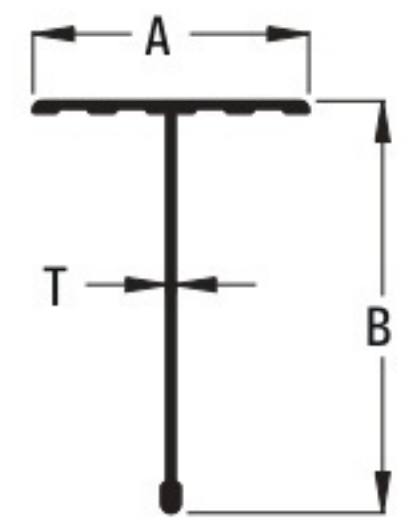

Sr. No	Section No.	A (mm)	B (mm)	T (mm)	Weight(Kg./Mtr)	Weight(Kg./12')
1	1649	60.20	90.00	1.80	0.806	2.950-3.250

TAPER BAR

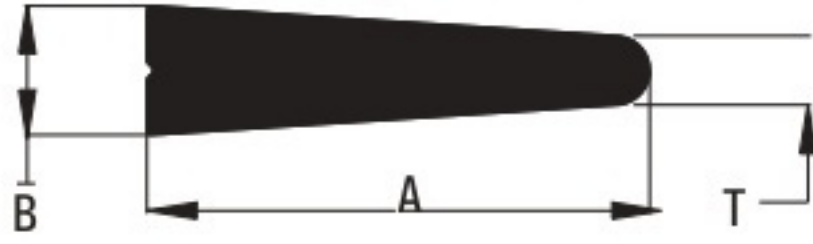

Sr. No	Section No.	A (mm)	B (mm)	T (mm)	Weight(Kg./Mtr)	Weight(Kg./12')
1	1179	31	8	4.25	0.491	1.800-2.000

FLUTED ANGLE

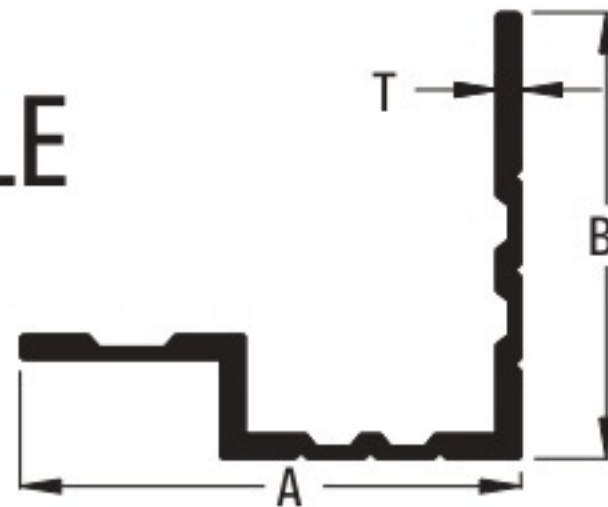

Sr. No	Section No.	A (mm)	B (mm)	T (mm)	Weight(Kg./Mtr)	Weight(Kg./12')
1	2485	50.5	45.00	2.5	0.601	2.200-2.400

A.C GRILL

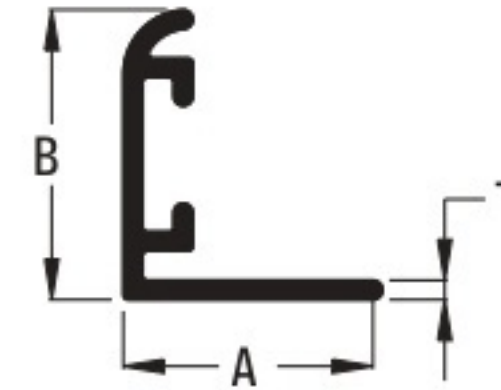

Sr. No	Section No.	A (mm)	B (mm)	T (mm)	Weight(Kg./Mtr)	Weight(Kg./12')
1	2415	16.00	17.90	1.20	0.137	0.50-0.70

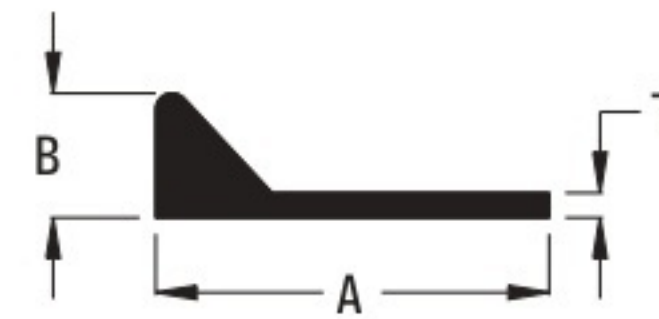

Sr. No	Section No.	A (mm)	B (mm)	T (mm)	Weight(Kg./Mtr)	Weight(Kg./12')
1	3927	16.30	5.10	1.95	0.144	0.42-0.47

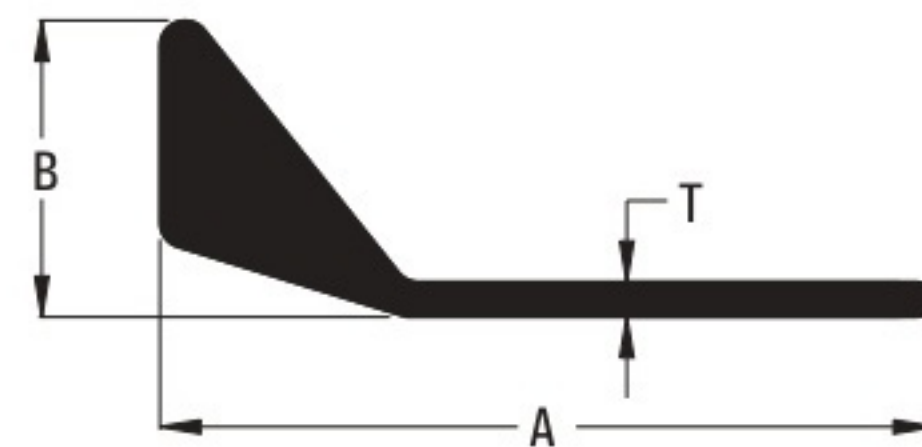

Sr. No	Section No.	A (mm)	B (mm)	T (mm)	Weight(Kg./Mtr)	Weight(Kg./12')
1	3926	15.40	5.90	0.70	0.058	0.213-0.270

DOOR CLOSER



Sr. No	Section No.	A (mm)	B (mm)	Weight(Kg./Mtr)	Weight(Kg./12')
1	3952	37.00	42.00	2.556	9.350-9.800

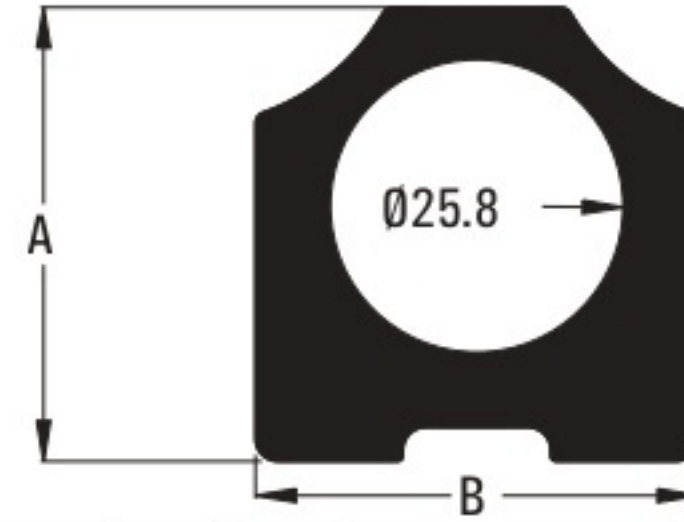

Sr. No	Section No.	A (mm)	B (mm)	T (mm)	Weight(Kg./Mtr)	Weight(Kg./12')
1	6082	40	39	---	2.324	8.500-8.700

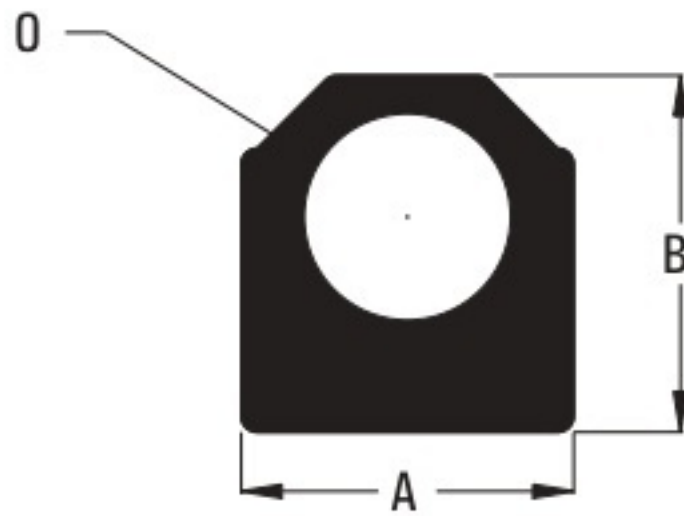

Sr. No	Section No.	A (mm)	B (mm)	Ø (mm)	Weight(Kg./Mtr)	Weight(Kg./12')
1	3938	41.00	44.00	25.50	3.166	11.580-11.780

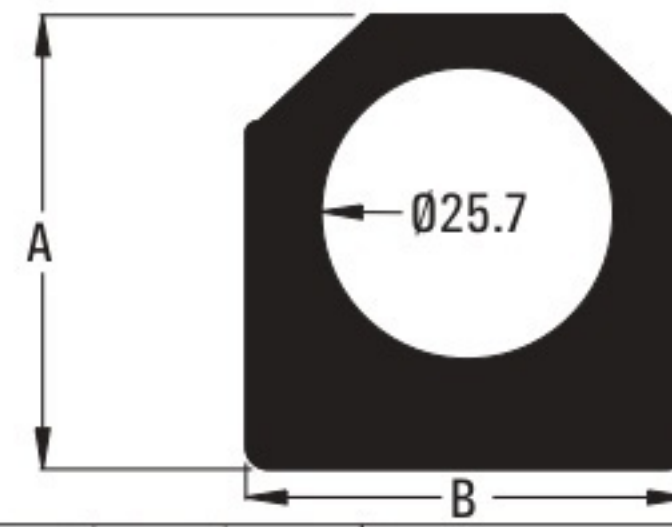

Sr. No	Section No.	A (mm)	B (mm)	T (mm)	Weight(Kg./Mtr)	Weight(Kg./12')
1	6083	40	39	---	2.461	9.000-9.300

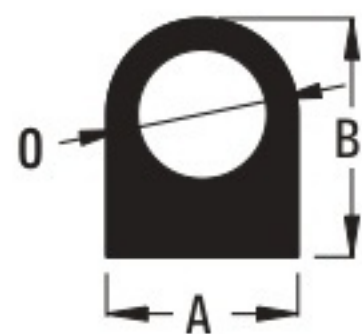

Sr. No	Section No.	A (mm)	B (mm)	Ø (mm)	Weight(Kg./Mtr)	Weight(Kg./12')
1	3936	11.80	14.70	8.00	0.219	0.80-1.00

MISCELLANEOUS

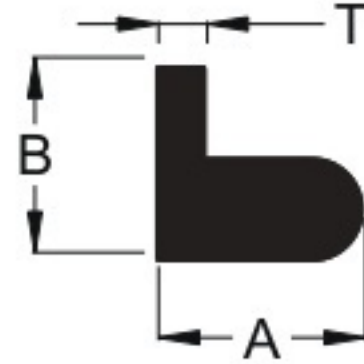

Sr. No	Section No.	A (mm)	B (mm)	T (mm)	Weight(Kg./Mtr)	Weight(Kg./12')
1	5041	25.45	24.00	6.00	1.008	3.690-3.890

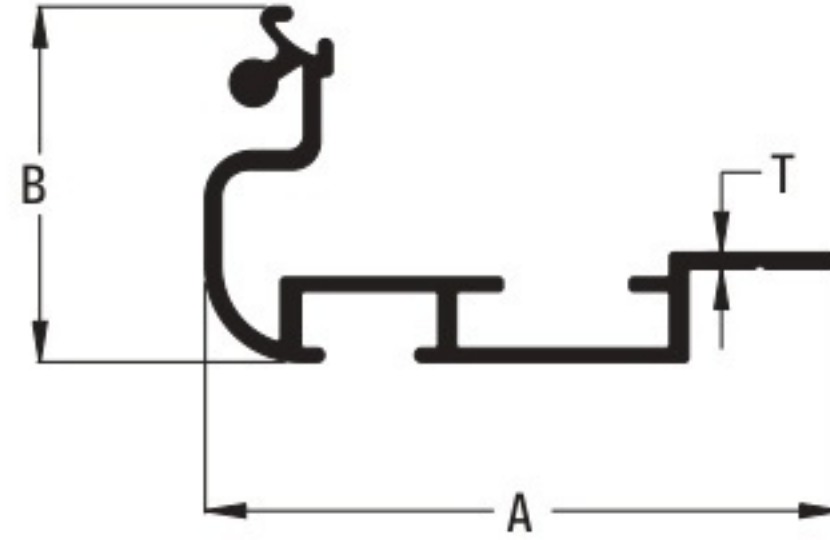

Sr. No	Section No.	A (mm)	B (mm)	T (mm)	Weight(Kg./Mtr)	Weight(Kg./12')
1	6181	39.5	22.1	1.0	0.254	0.930-1.080

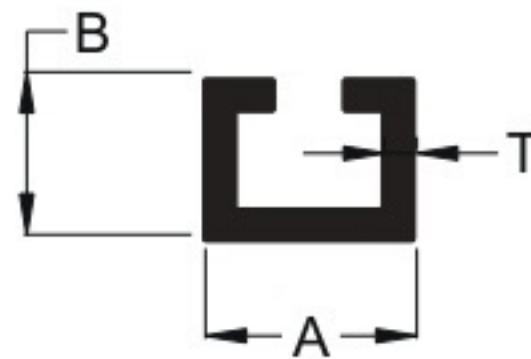

Sr. No	Section No.	A (mm)	B (mm)	T (mm)	Weight(Kg./Mtr)	Weight(Kg./12')
1	5042	26.0	20.0	4.00	0.725	2.650-2.850

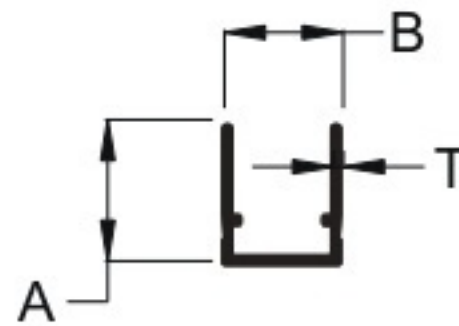
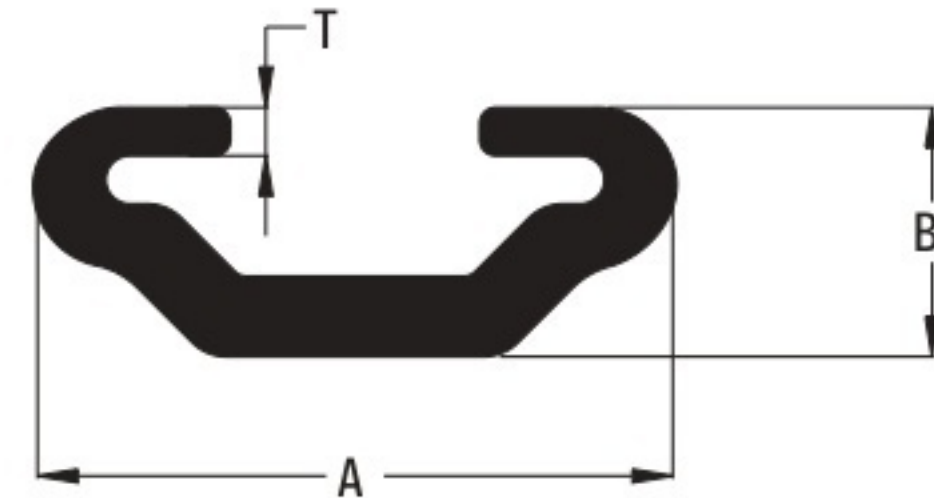

Sr. No	Section No.	A (mm)	B (mm)	T (mm)	Weight(Kg./Mtr)	Weight(Kg./12')
1	6020	15.1	12.7	1.05	0.118	0.435-0.635

Sr. No	Section No.	A (mm)	B (mm)	T (mm)	Weight(Kg./Mtr)	Weight(Kg./12')
1	6182	39.5	15.5	3.0	0.761	2.785-3.050

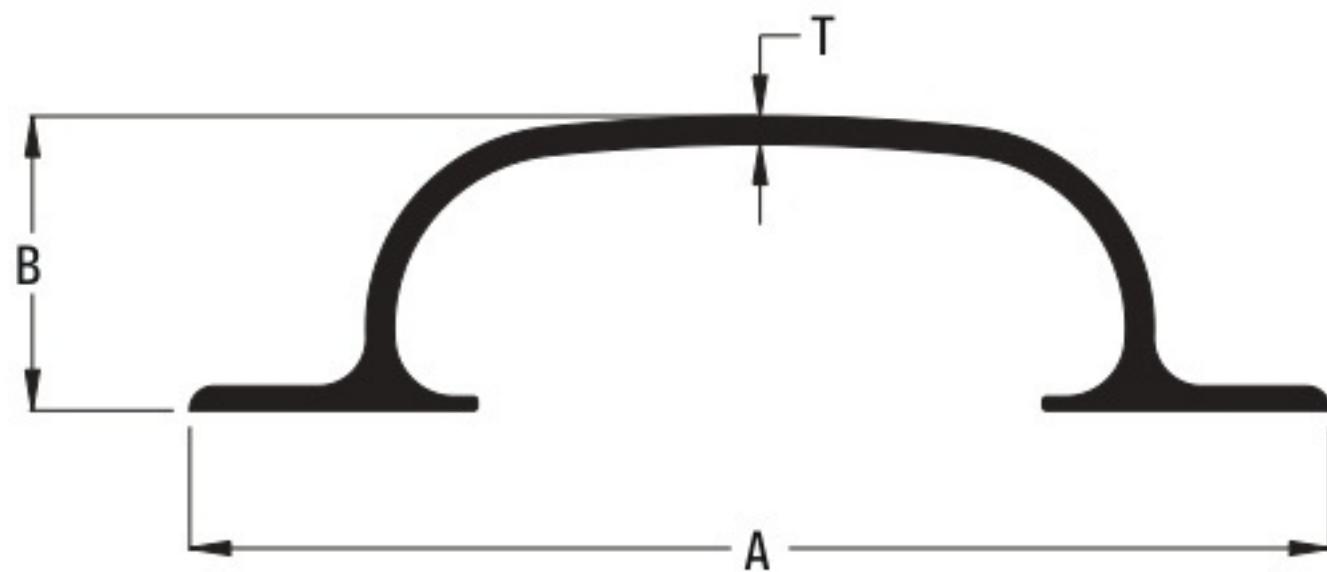

Sr. No	Section No.	A (mm)	B (mm)	T (mm)	Weight(Kg./Mtr)	Weight(Kg./12')
1	3875	141.4	36.5	3.5	1.872	6.850-7.050

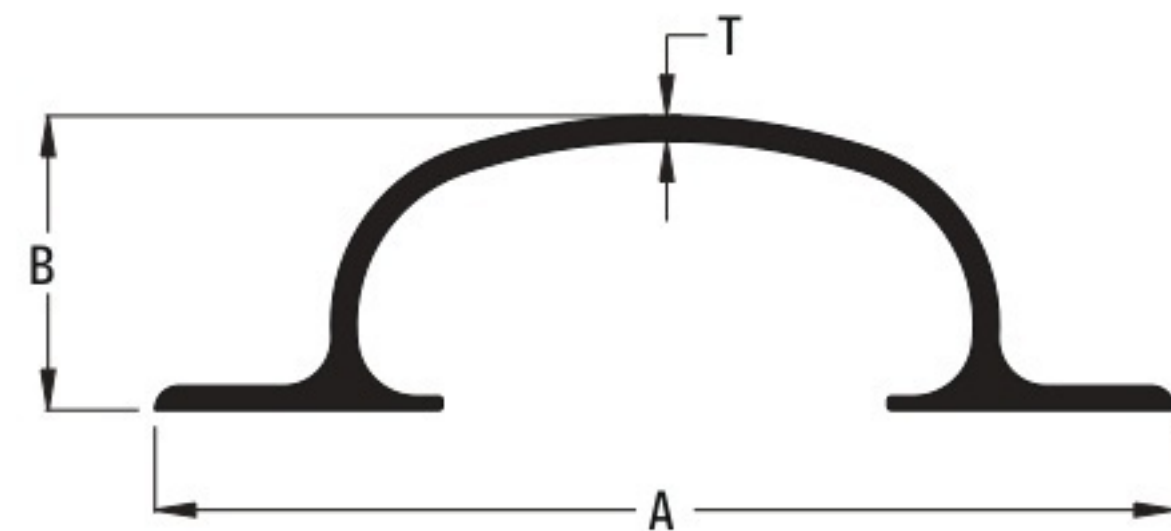

Sr. No	Section No.	A (mm)	B (mm)	T (mm)	Weight(Kg./Mtr)	Weight(Kg./12')
1	3874	126.5	36.5	3.10	1.613	5.900-6.100

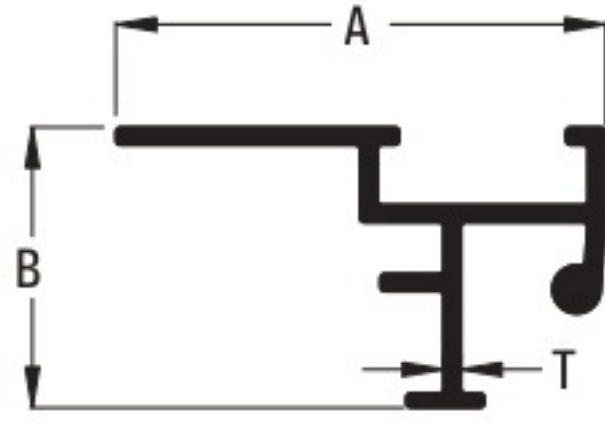

Sr. No	Section No.	A (mm)	B (mm)	T (mm)	Weight(Kg./Mtr)	Weight(Kg./12')
1	4503	30.20	17.30	1.10	0.205	0.750-0.950

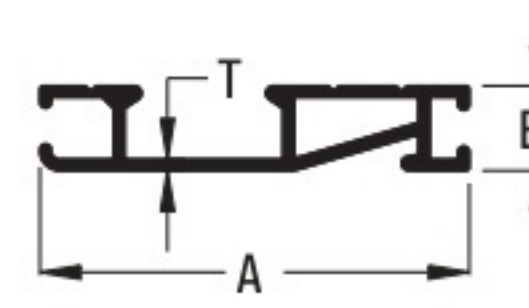

Sr. No	Section No.	A (mm)	B (mm)	T (mm)	Weight(Kg./Mtr)	Weight(Kg./12')
1	4510	38.00	7.50	1.00	0.246	0.900-1.100

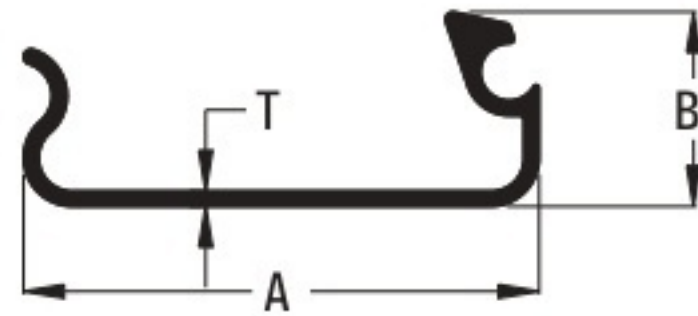

Sr. No	Section No.	A (mm)	B (mm)	T (mm)	Weight(Kg./Mtr)	Weight(Kg./12')
1	4504	25.40	12.00	0.95	0.137	0.500-0.650
1	4505	18.00	12.00	0.95	0.123	0.450-0.600
1	4506	31.80	12.00	0.95	0.150	0.550-0.750

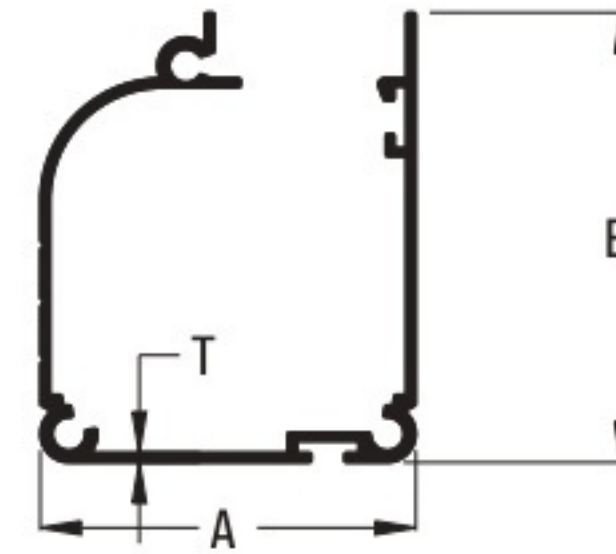

Sr. No	Section No.	A (mm)	B (mm)	T (mm)	Weight(Kg./Mtr)	Weight(Kg./12')
1	4511	45.90	55.00	1.20	0.683	2.500-2.800

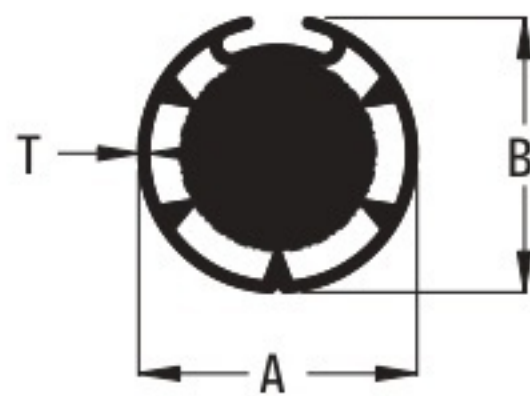

Sr. No	Section No.	A (mm)	B (mm)	T (mm)	Weight(Kg./Mtr)	Weight(Kg./12')
1	4508	27.00	26.62	1.00	0.312	1.140-1.400

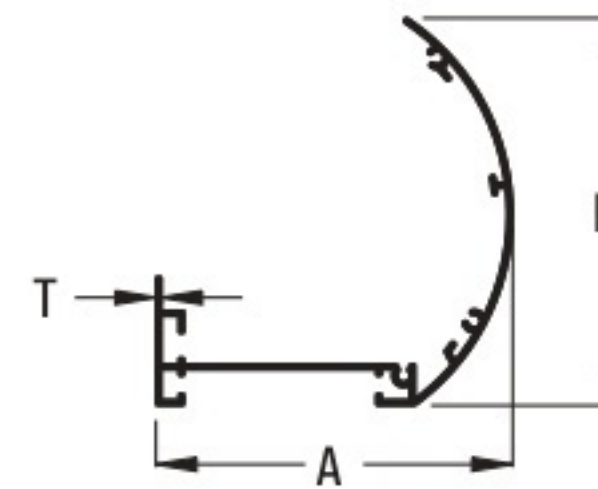

Sr. No	Section No.	A (mm)	B (mm)	T (mm)	Weight(Kg./Mtr)	Weight(Kg./12')
1	4512	70.66	76.7	1.10	0.670	2.450-2.700

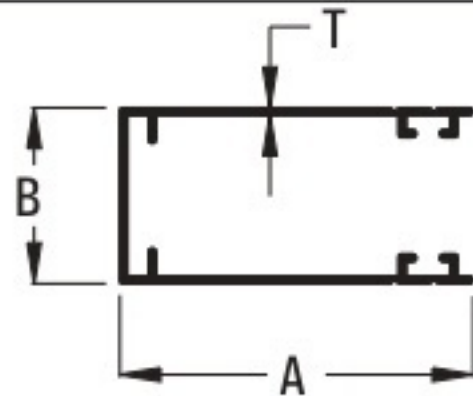

Sr. No	Section No.	A (mm)	B (mm)	T (mm)	Weight(Kg./Mtr)	Weight(Kg./12')
1	4509	45.00	22.40	0.95	0.339	1.240-1.440

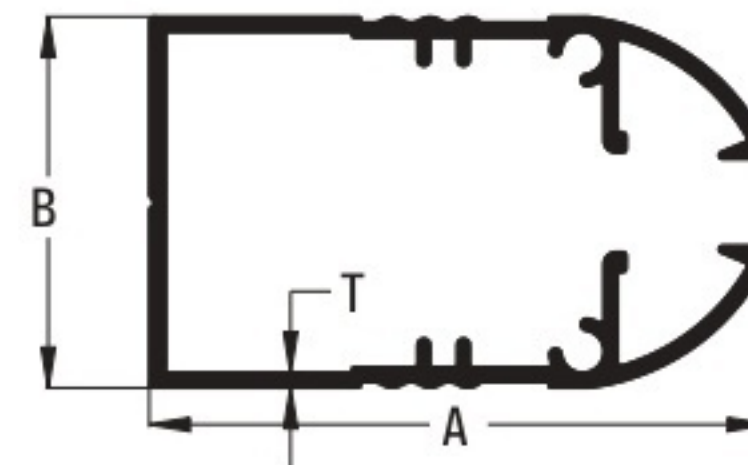

Sr. No	Section No.	A (mm)	B (mm)	T (mm)	Weight(Kg./Mtr)	Weight(Kg./12')
1	4513	50.00	30.00	1.35	0.617	2.260-2.460

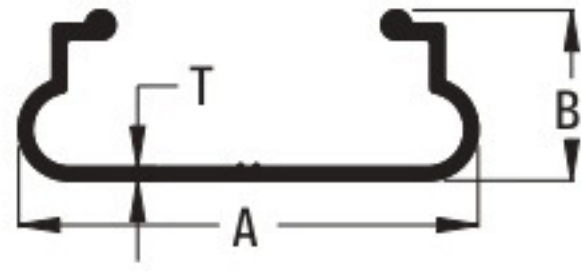

Sr. No	Section No.	A (mm)	B (mm)	T (mm)	Weight(Kg./Mtr)	Weight(Kg./12')
1	4514	29.00	10.75	0.85	0.137	0.500-0.700

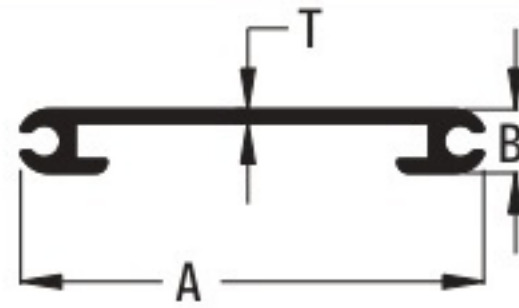

Sr. No	Section No.	A (mm)	B (mm)	T (mm)	Weight(Kg./Mtr)	Weight(Kg./12')
1	4517	48.00	23.50	1.25	0.328	1.200-1.300

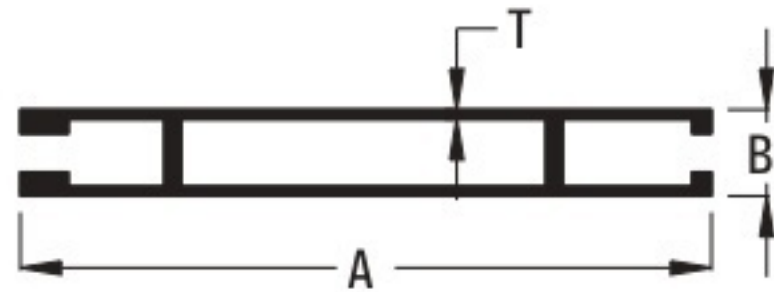

Sr. No	Section No.	A (mm)	B (mm)	T (mm)	Weight(Kg./Mtr)	Weight(Kg./12')
1	4518	27.00	26.62	1.00	0.513	1.875-2.100

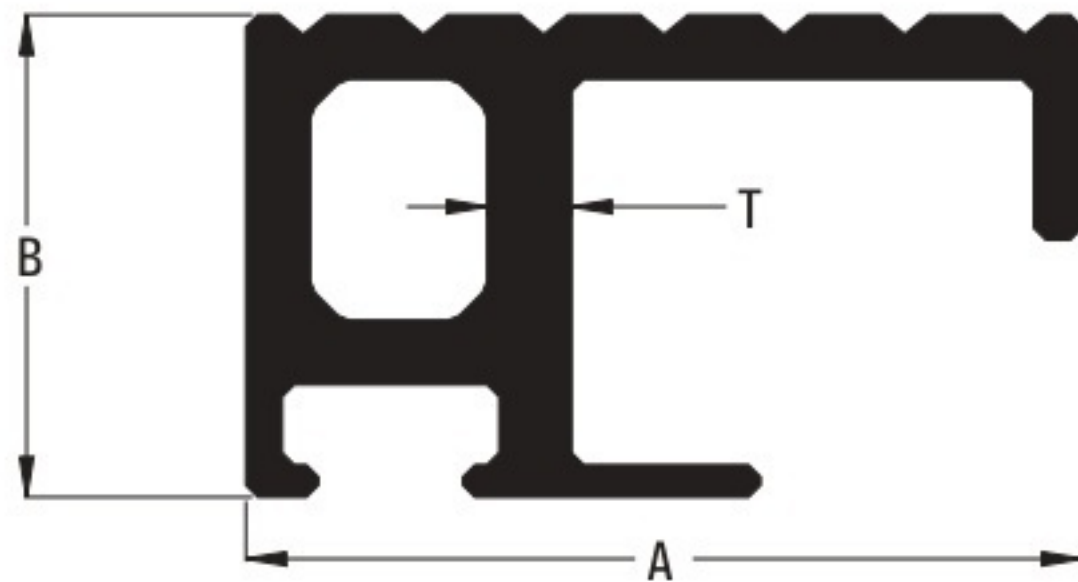

Sr. No	Section No.	A (mm)	B (mm)	T (mm)	Weight(Kg./Mtr)	Weight(Kg./12')
1	6183	52.0	30.0	5.3	1.435	5.250-5.550

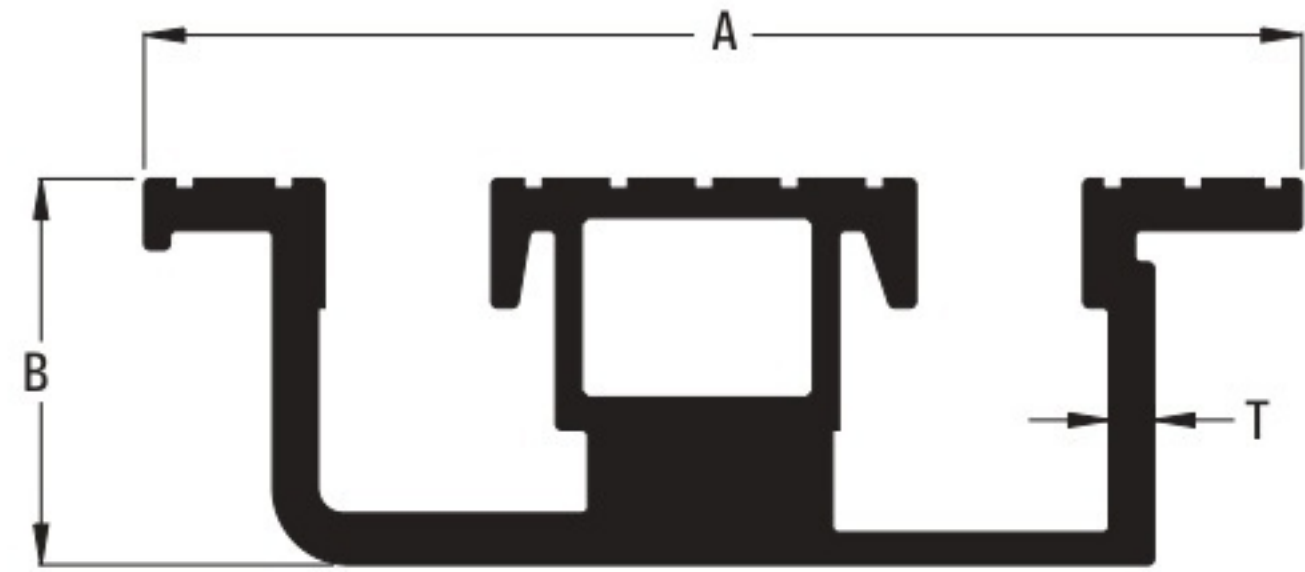

Sr. No	Section No.	A (mm)	B (mm)	T (mm)	Weight(Kg./Mtr)	Weight(Kg./12')
1	6184	90.0	30.0	3.5	2.405	8.800-9.100

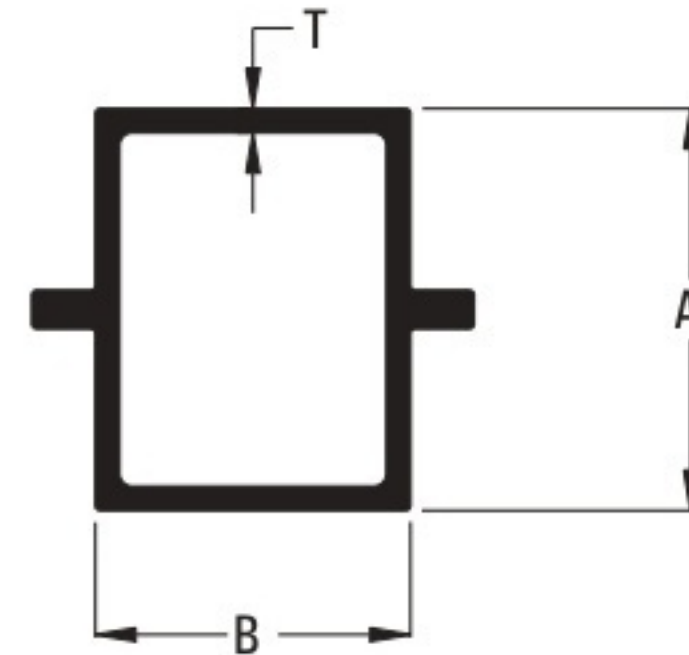

Sr. No	Section No.	A (mm)	B (mm)	T (mm)	Weight(Kg./Mtr)	Weight(Kg./12')
1	6185	25.0	19.6	1.5	0.389	1.425-1.625

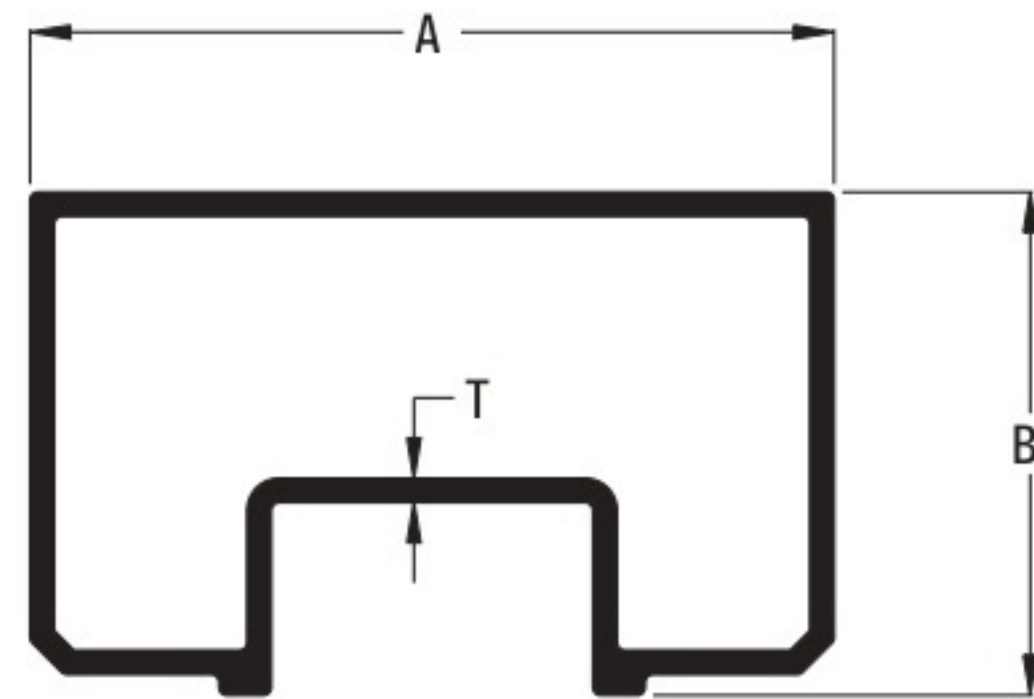

Sr. No	Section No.	A (mm)	B (mm)	T (mm)	Weight(Kg./Mtr)	Weight(Kg./12')
1	6186	50.0	30.3	1.5	0.989	2.630-2.830

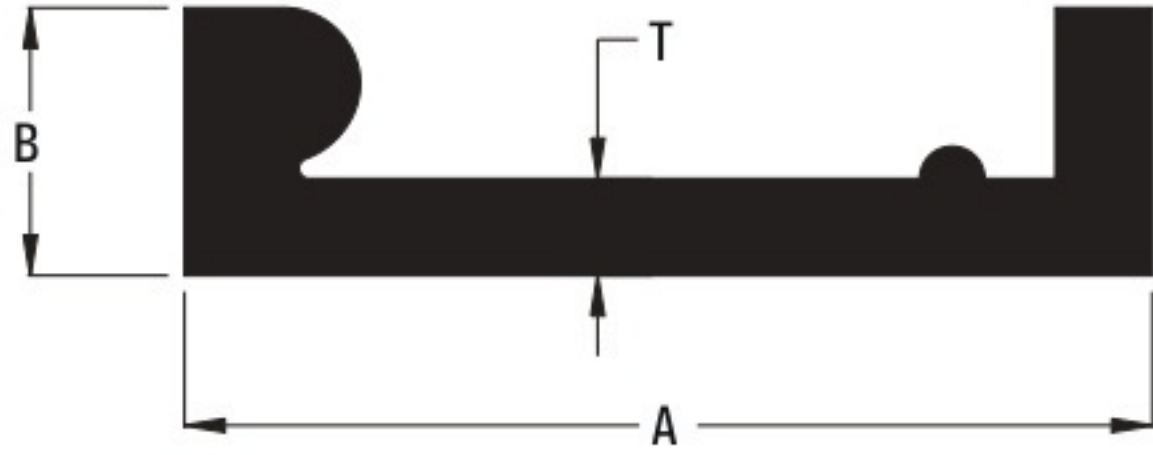

Sr. No	Section No.	A (mm)	B (mm)	T (mm)	Weight(Kg./Mtr)	Weight(Kg./12')
1	6187	150.0	41.5	15.0	8.967	32.800-33.300



Sr. No	Section No.	A (mm)	B (mm)	T (mm)	Weight(Kg./Mtr)	Weight(Kg./12')
1	6190	174.0	58.0	18.0	13.205	48.300-48.600



Sr. No	Section No.	A (mm)	B (mm)	T (mm)	Weight(Kg./Mtr)	Weight(Kg./12')
1	6188	175.0	43.0	21.0	12.986	47.500-47.900

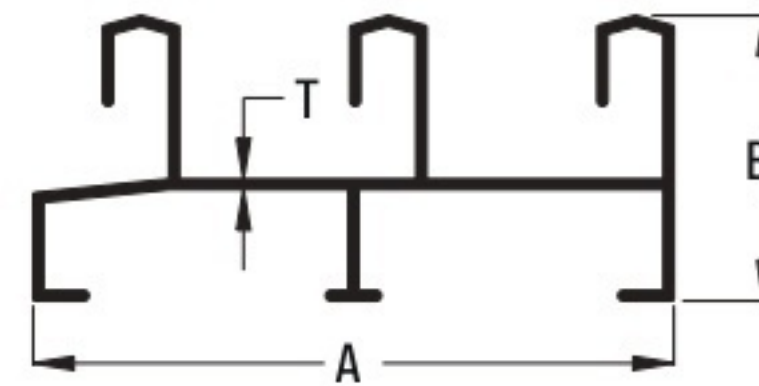

Sr. No	Section No.	A (mm)	B (mm)	T (mm)	Weight(Kg./Mtr)	Weight(Kg./12')
1	5017	92.00	41.00	1.50	1.148	4.200-4.600



Sr. No	Section No.	A (mm)	B (mm)	T (mm)	Weight(Kg./Mtr)	Weight(Kg./12')
1	6189	175.0	53.0	19.0	15.283	55.900-56.300

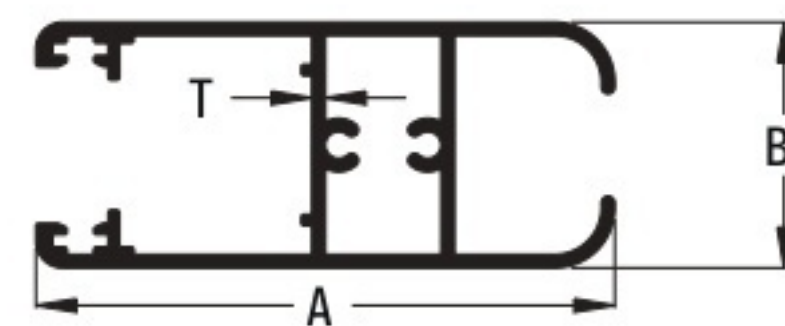

Sr. No	Section No.	A (mm)	B (mm)	T (mm)	Weight(Kg./Mtr)	Weight(Kg./12')
1	5018	65.00	27.60	1.50	0.929	3.400-3.800

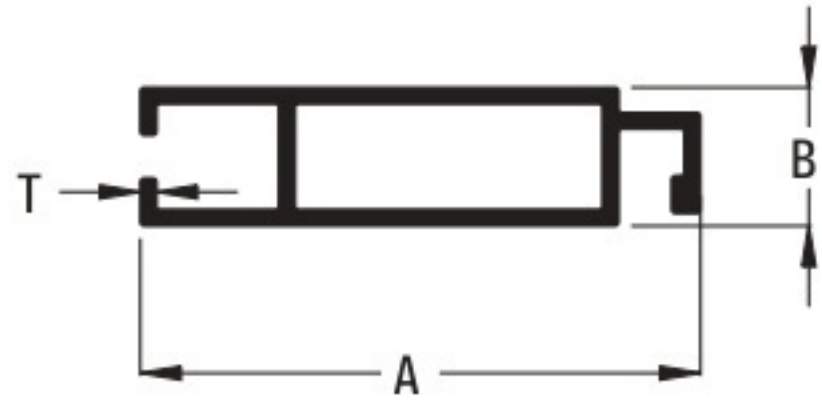

Sr. No	Section No.	A (mm)	B (mm)	T (mm)	Weight(Kg./Mtr)	Weight(Kg./12')
1	5019	45.50	11.00	1.30	0.396	1.450-1.750

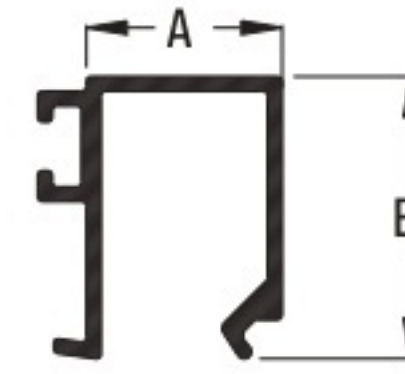

Sr. No	Section No.	A (mm)	B (mm)	T (mm)	Weight(Kg./Mtr)	Weight(Kg./12')
1	5023	12.07	17.40	0.90	0.150	0.550-0.750

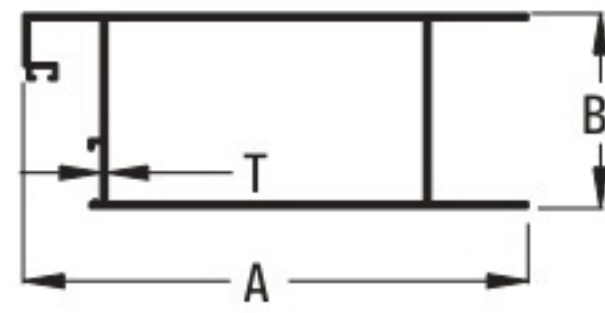

Sr. No	Section No.	A (mm)	B (mm)	T (mm)	Weight(Kg./Mtr)	Weight(Kg./12')
1	5020	114.00	44.00	1.50	1.291	4.725-5.125

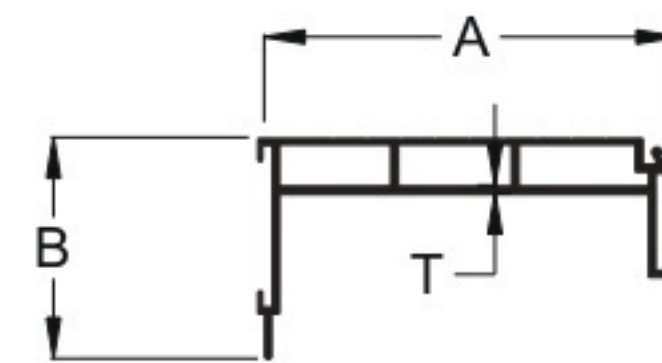

Sr. No	Section No.	A (mm)	B (mm)	T (mm)	Weight(Kg./Mtr)	Weight(Kg./12')
1	5031	127.0	68.0	2.4	2.303	8.425-8.650

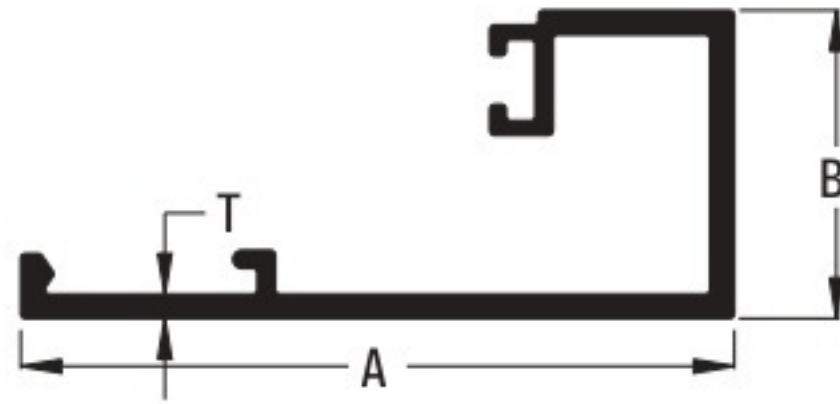

Sr. No	Section No.	A (mm)	B (mm)	T (mm)	Weight(Kg./Mtr)	Weight(Kg./12')
1	5021	44.00	19.00	1.50	0.342	1.250-1.550

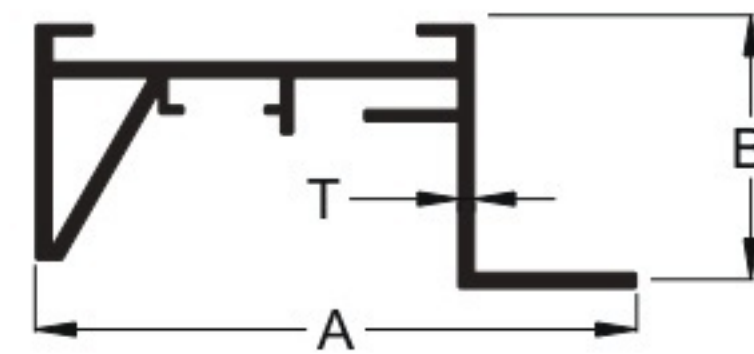

Sr. No	Section No.	A (mm)	B (mm)	T (mm)	Weight(Kg./Mtr)	Weight(Kg./12')
1	5033	74.0	29.00	1.90	0.932	3.410-3.610

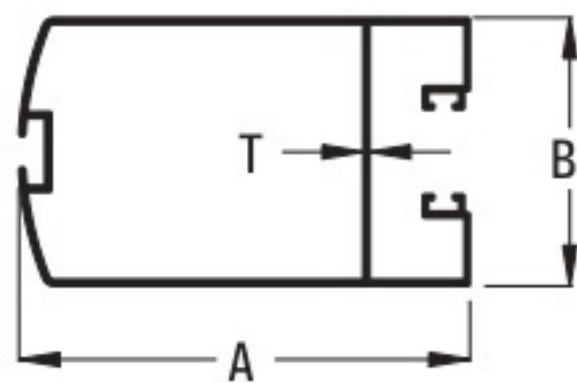

Sr. No	Section No.	A (mm)	B (mm)	T (mm)	Weight(Kg./Mtr)	Weight(Kg./12')
1	5022	73.90	44.00	1.10	0.842	3.080-3.480

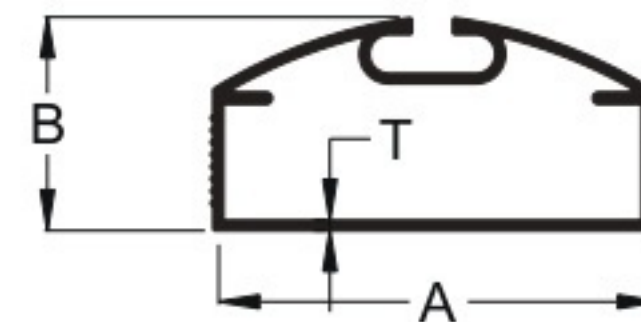

Sr. No	Section No.	A (mm)	B (mm)	T (mm)	Weight(Kg./Mtr)	Weight(Kg./12')
1	5034	54.10	26.27	1.30	0.629	2.300-2.500

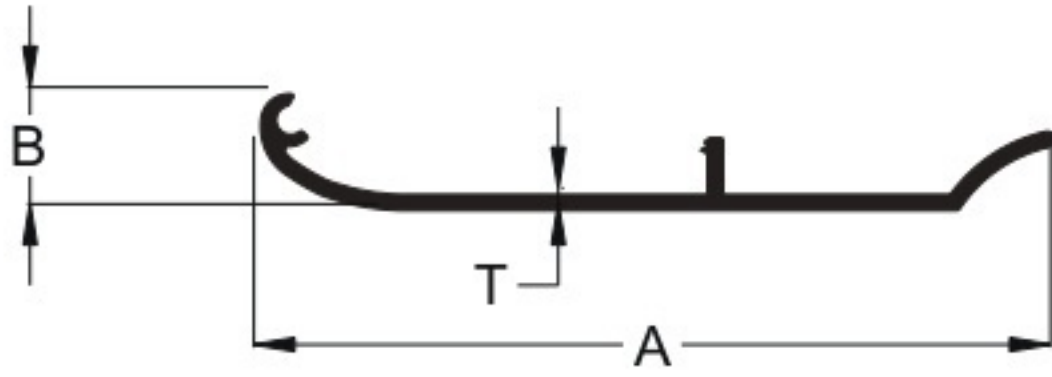

Sr. No	Section No.	A (mm)	B (mm)	T (mm)	Weight(Kg./Mtr)	Weight(Kg./12')
1	5035	98.00	14.38	1.90	0.623	2.280-2.500

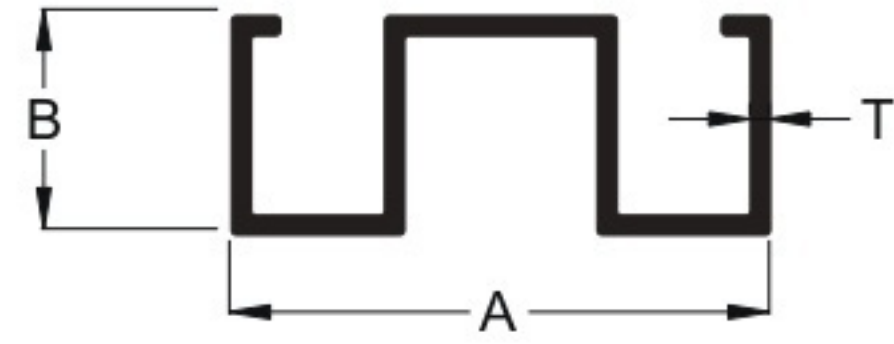

Sr. No	Section No.	A (mm)	B (mm)	T (mm)	Weight(Kg./Mtr)	Weight(Kg./12')
1	5040	33.2	13.5	1.2	0.279	1.020-1.150

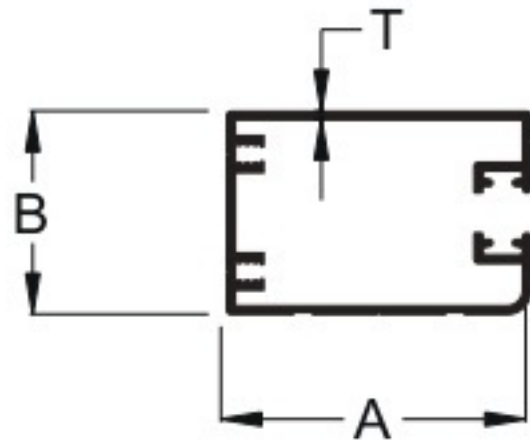

Sr. No	Section No.	A (mm)	B (mm)	T (mm)	Weight(Kg./Mtr)	Weight(Kg./12')
1	5036	75.0	50.0	2.0	1.627	5.950-6.250



Sr. No	Section No.	A (mm)	B (mm)	T (mm)	Weight(Kg./Mtr)	Weight(Kg./12')
1	5043	43.0	19.0	4.0	1.203	4.400-4.600

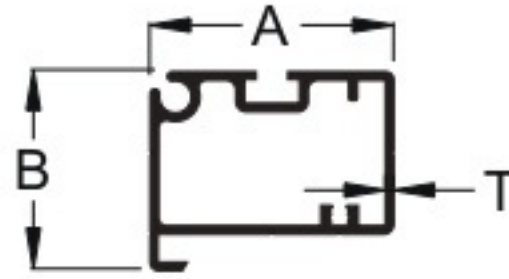

Sr. No	Section No.	A (mm)	B (mm)	T (mm)	Weight(Kg./Mtr)	Weight(Kg./12')
1	5037	60.0	49.00	2.00	1.383	5.060-5.360



Sr. No	Section No.	A (mm)	B (mm)	T (mm)	Weight(Kg./Mtr)	Weight(Kg./12')
1	5044	44.0	38.0	15.0	3.199	11.700-12.000

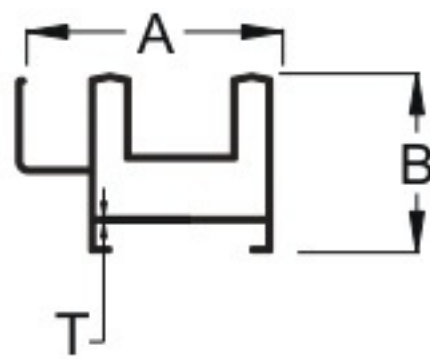

Sr. No	Section No.	A (mm)	B (mm)	T (mm)	Weight(Kg./Mtr)	Weight(Kg./12')
1	5038	63.0	44.0	1.30	0.888	3.250-3.450

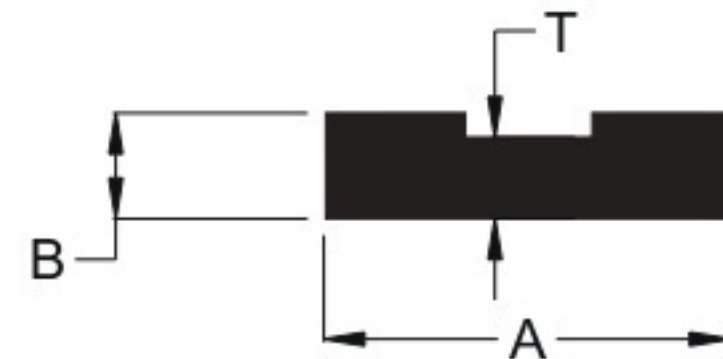

Sr. No	Section No.	A (mm)	B (mm)	T (mm)	Weight(Kg./Mtr)	Weight(Kg./12')
1	5045	50.0	13.00	10.00	1.629	5.960-6.100



Sr. No	Section No.	A (mm)	B (mm)	T (mm)	Weight(Kg./Mtr)	Weight(Kg./12')
1	5046	29.0	18.0	5.00	0.519	1.900-2.100

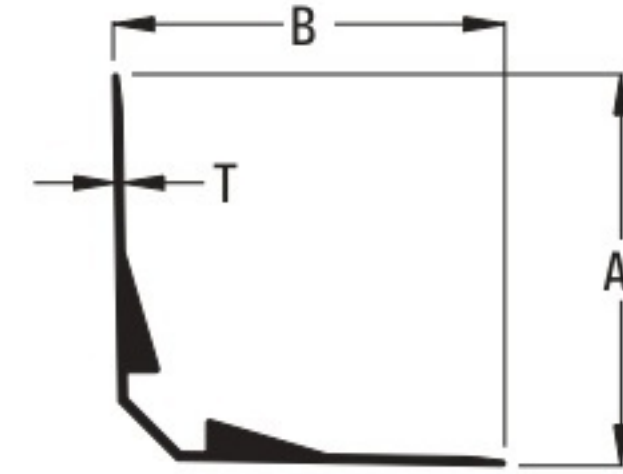

Sr. No	Section No.	A (mm)	B (mm)	T (mm)	Weight(Kg./Mtr)	Weight(Kg./12')
1	4526	37.86	37.86	0.8	0.255	0.935-1.135

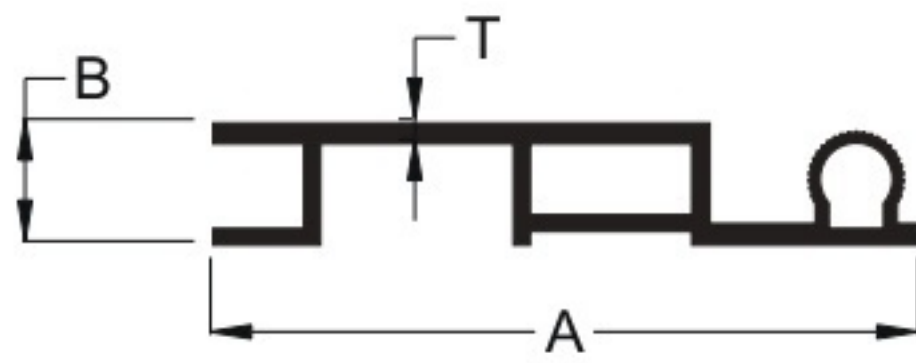

Sr. No	Section No.	A (mm)	B (mm)	T (mm)	Weight(Kg./Mtr)	Weight(Kg./12')
1	5047	87.0	15.0	2.5	1.080	3.950-4.150



Sr. No	Section No.	A (mm)	B (mm)	T (mm)	Weight(Kg./Mtr)	Weight(Kg./12')
1	5051	31.40	19.50	0.95	0.259	0.950-1.150

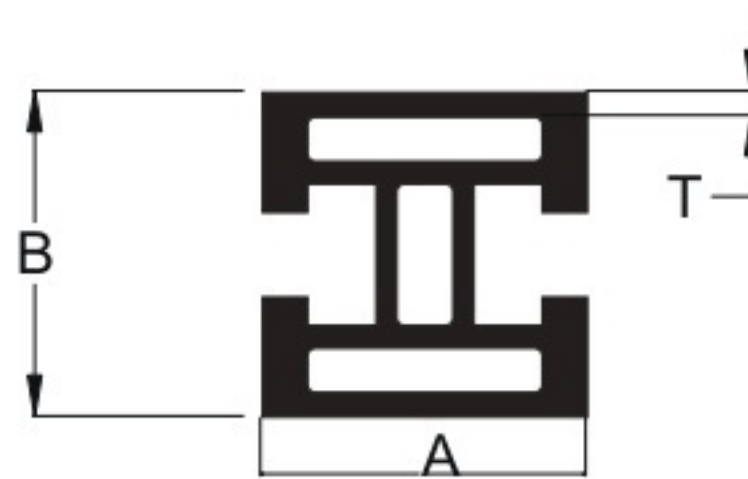

Sr. No	Section No.	A (mm)	B (mm)	T (mm)	Weight(Kg./Mtr)	Weight(Kg./12')
1	5048	40.0	40.0	3.0	2.023	7.400-7.700

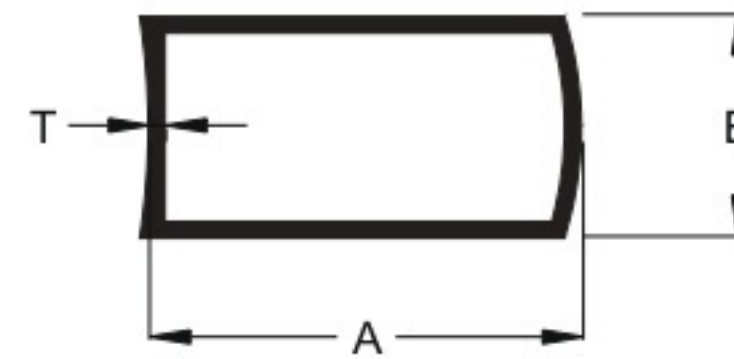

Sr. No	Section No.	A (mm)	B (mm)	T (mm)	Weight(Kg./Mtr)	Weight(Kg./12')
1	5052	25.4	13.0	0.95	0.191	0.700-0.850



Sr. No	Section No.	A (mm)	B (mm)	T (mm)	Weight(Kg./Mtr)	Weight(Kg./12')
1	5049	45.0	40.00	8.00	3.070	11.230-11.500

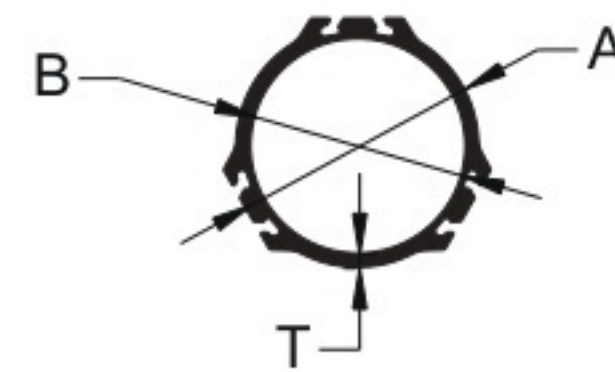

Sr. No	Section No.	A (mm)	B (mm)	T (mm)	Weight(Kg./Mtr)	Weight(Kg./12')
1	5053	39.90	35.30	2.3	0.847	3.100-3.400

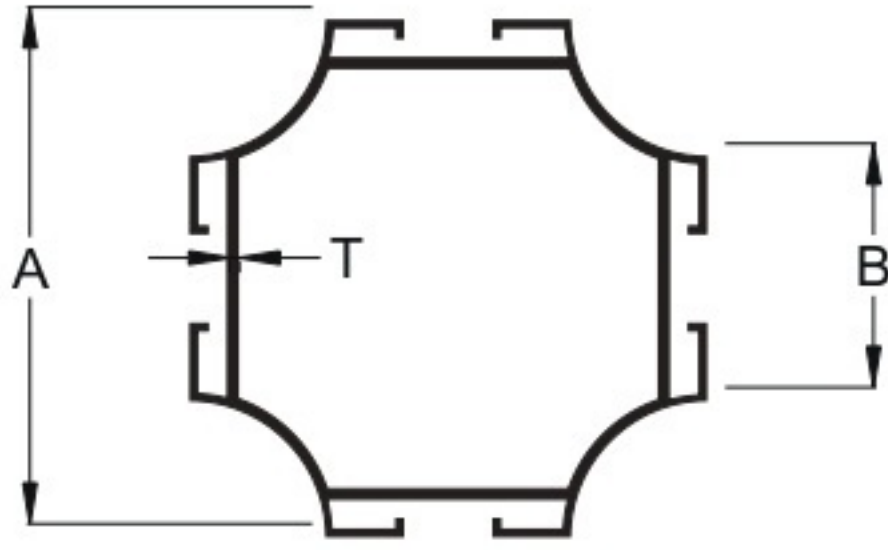

Sr. No	Section No.	A (mm)	B (mm)	T (mm)	Weight(Kg./Mtr)	Weight(Kg./12')
1	5100	158.90	75.0	3.0	5.285	19.330-20.000Kg./12'

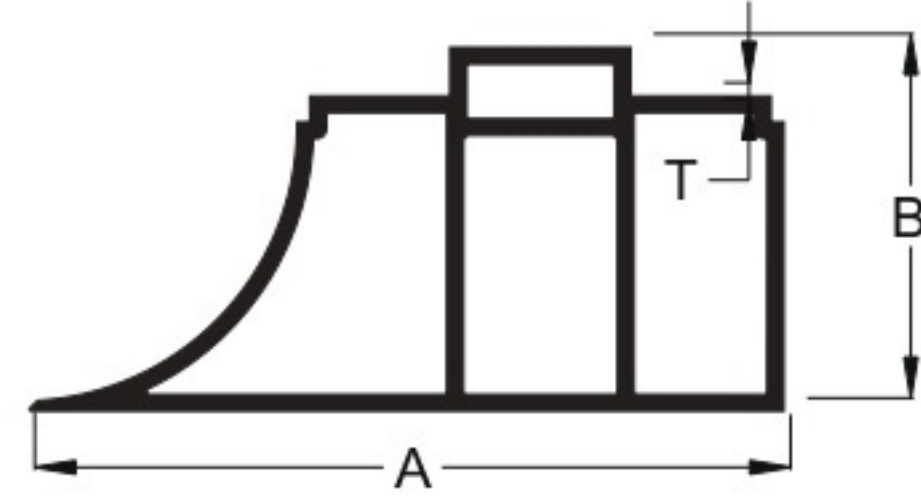

Sr. No	Section No.	A (mm)	B (mm)	T (mm)	Weight(Kg./Mtr)	Weight(Kg./12')
1	5104	116.30	56.0	2.50	3.773	13.800-14.300

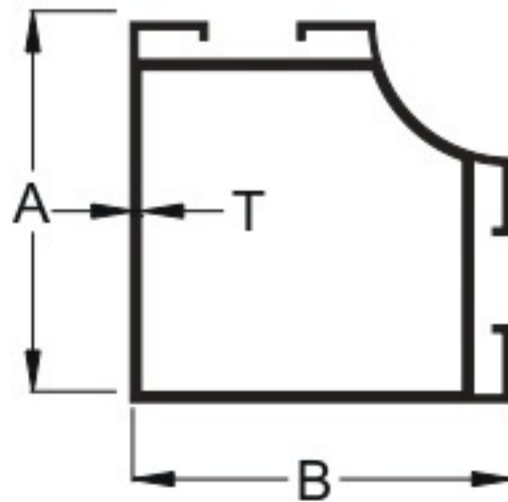

Sr. No	Section No.	A (mm)	B (mm)	T (mm)	Weight(Kg./Mtr)	Weight(Kg./12')
1	5101	116.95	117.0	3.0	0.964	14.500-14.800

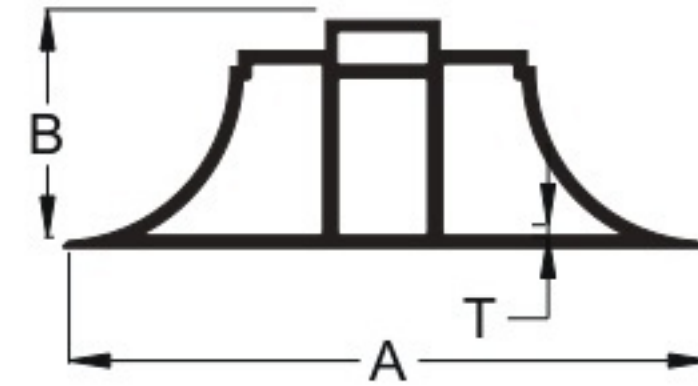

Sr. No	Section No.	A (mm)	B (mm)	T (mm)	Weight(Kg./Mtr)	Weight(Kg./12')
1	5105	157.5	56.0	3.0	1.709	6.250-6.450

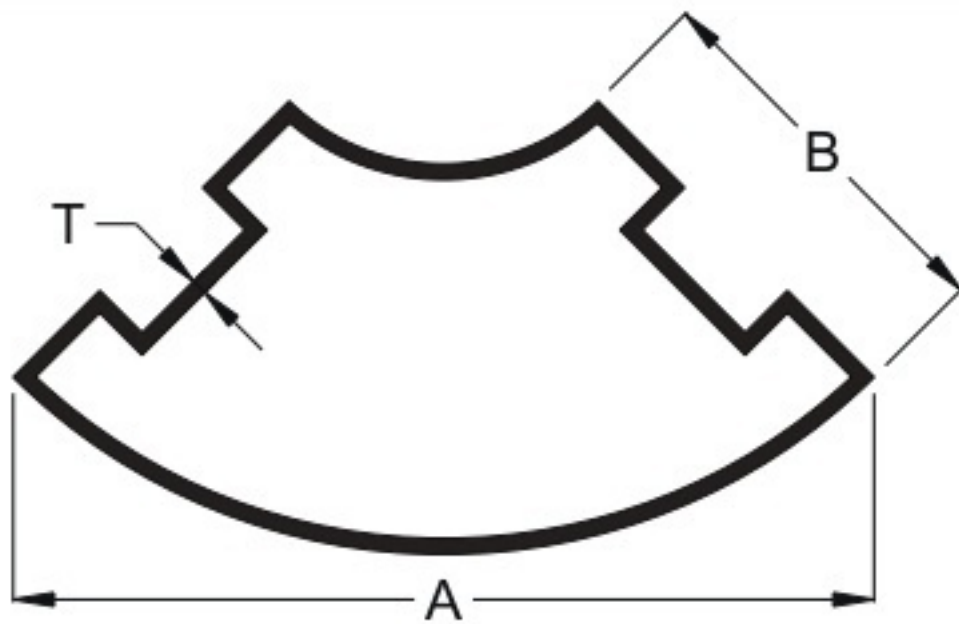

Sr. No	Section No.	A (mm)	B (mm)	T (mm)	Weight(Kg./Mtr)	Weight(Kg./12')
1	5102	165.39	75.0	3.0	3.439	12.580 - 13.050

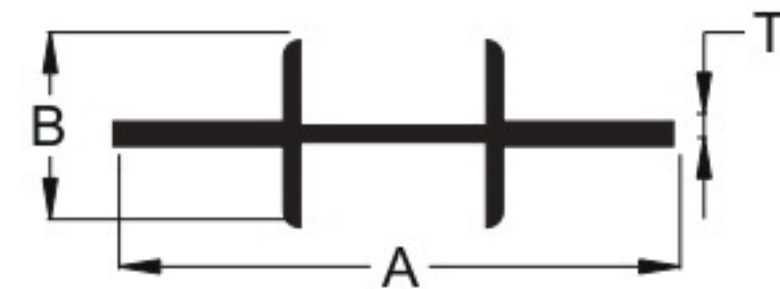

Sr. No	Section No.	A (mm)	B (mm)	T (mm)	Weight(Kg./Mtr)	Weight(Kg./12')
1	5106	69.0	23.0	3.0	0.703	2.570-2.770

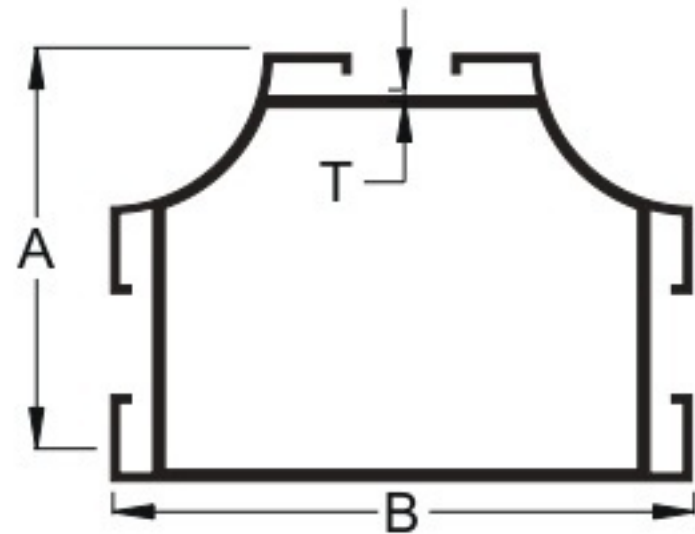

Sr. No	Section No.	A (mm)	B (mm)	T (mm)	Weight(Kg./Mtr)	Weight(Kg./12')
1	5103	116.95	158.90	3.0	4.702	17.200-17.600

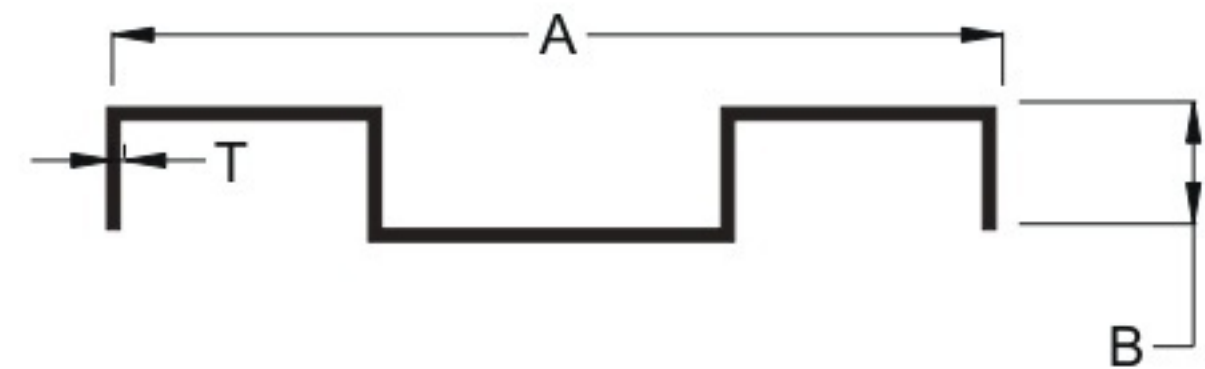

Sr. No	Section No.	A (mm)	B (mm)	T (mm)	Weight(Kg./Mtr)	Weight(Kg./12')
1	5107	73.0	10.0	2.0	0.301	1.100-1.300

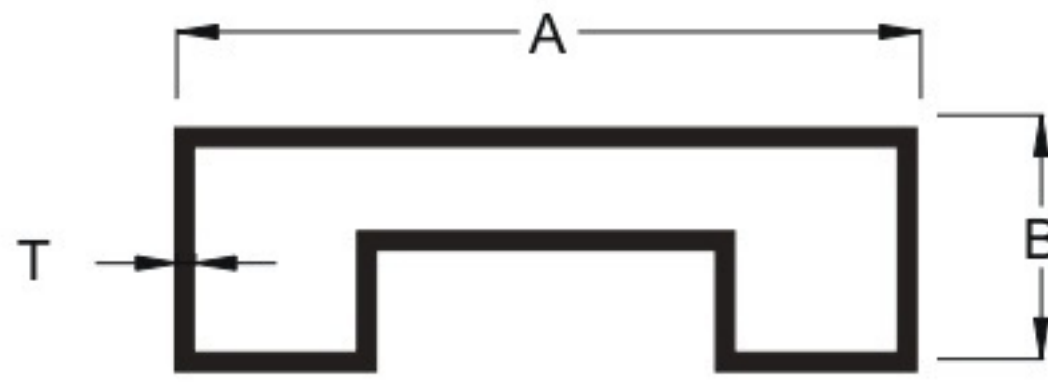

Sr. No	Section No.	A (mm)	B (mm)	T (mm)	Weight(Kg./Mtr)	Weight(Kg./12')
1	5108	61.0	20.0	1.50	0.711	2.600-2.800

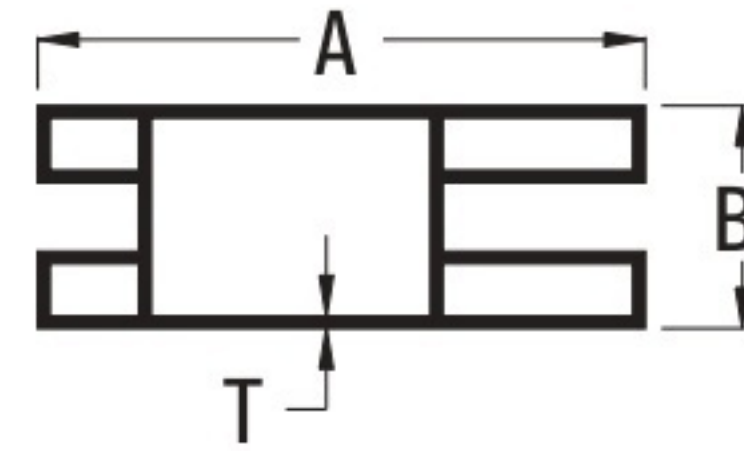

Sr. No	Section No.	A (mm)	B (mm)	T (mm)	Weight(Kg./Mtr)	Weight(Kg./12')
1	6102	150.0	55.0	3.0	4.866	17.800-18.300

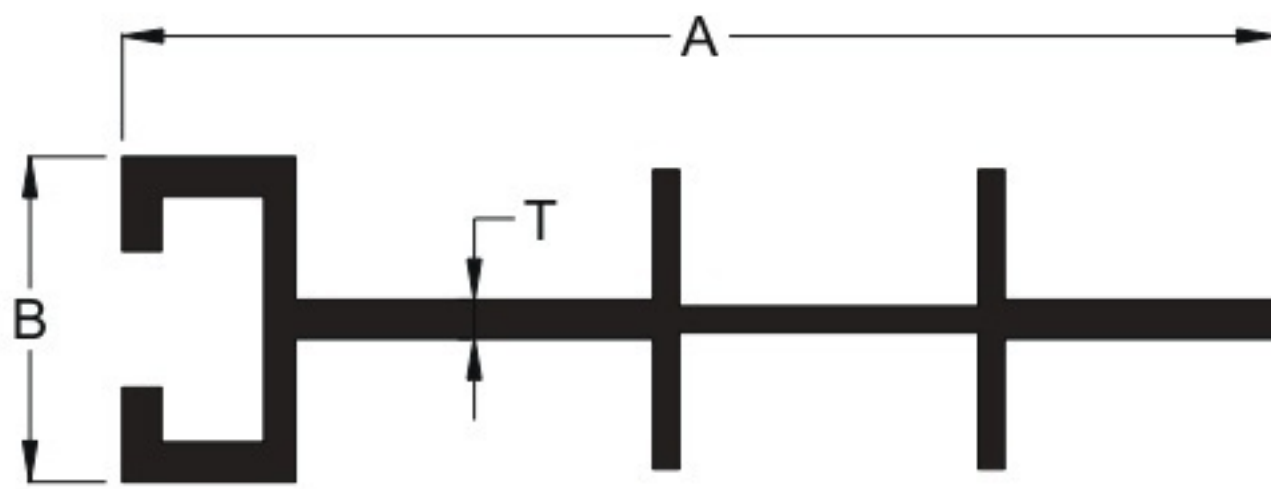

Sr. No	Section No.	A (mm)	B (mm)	T (mm)	Weight(Kg./Mtr)	Weight(Kg./12')
1	5109	88.8	25.0	3.00	1.175	4.300-4.500

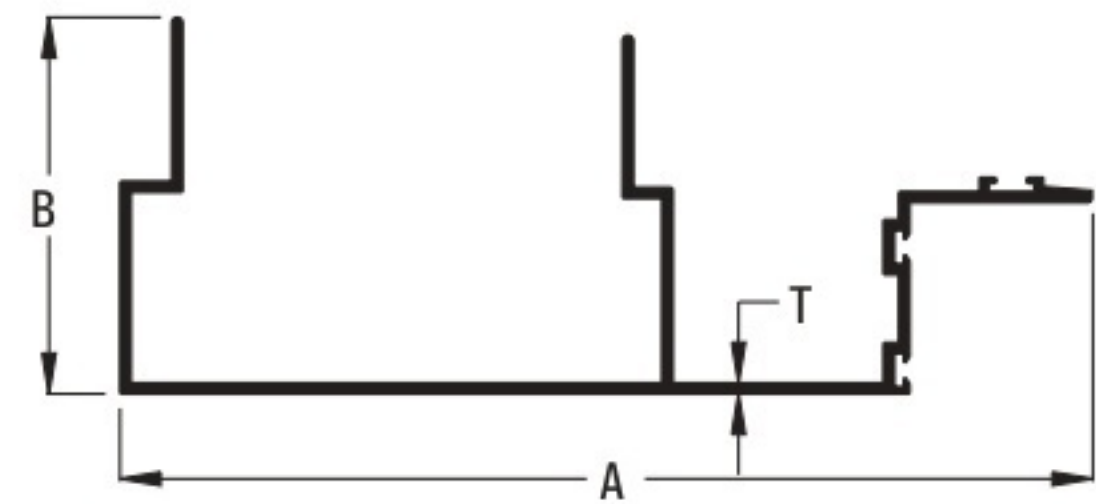

Sr. No	Section No.	A (mm)	B (mm)	T (mm)	Weight(Kg./Mtr)	Weight(Kg./12')
1	6103	160.0	62.0	1.80	1.654	6.050-6.250

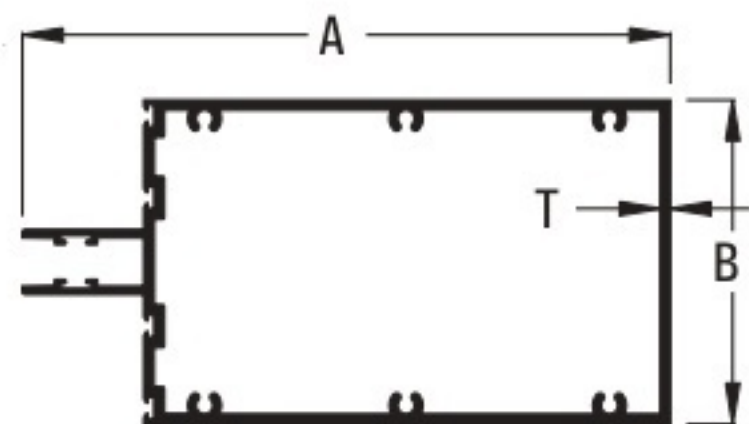

Sr. No	Section No.	A (mm)	B (mm)	T (mm)	Weight(Kg./Mtr)	Weight(Kg./12')
1	6100	160.0	80.0	2.50	3.554	13.000-13.300

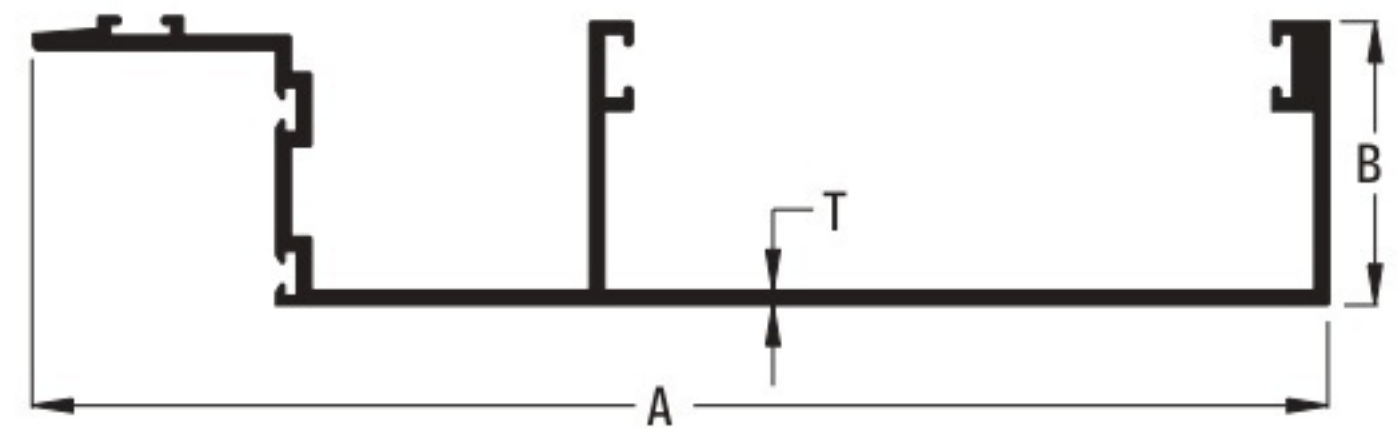

Sr. No	Section No.	A (mm)	B (mm)	T (mm)	Weight(Kg./Mtr)	Weight(Kg./12')
1	6104	160.0	35.0	1.80	1.613	5.900-6.100

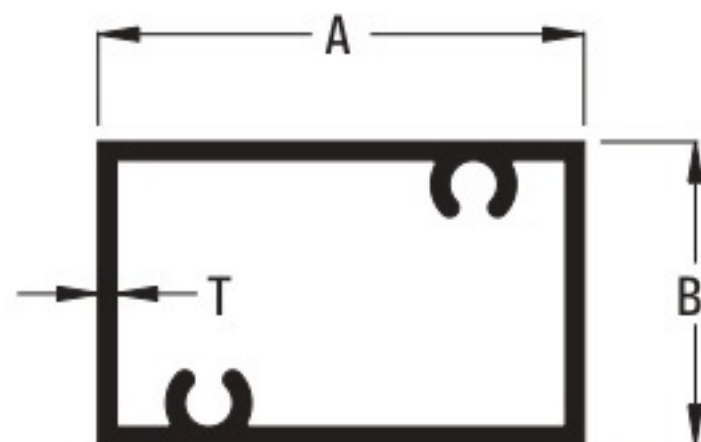

Sr. No	Section No.	A (mm)	B (mm)	T (mm)	Weight(Kg./Mtr)	Weight(Kg./12')
1	6101	40.0	25.0	1.50	0.588	2.150-2.350

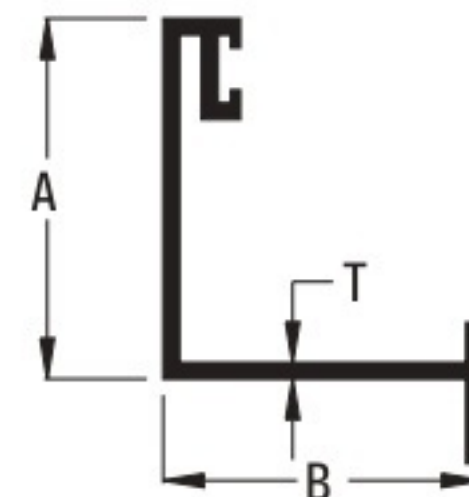

Sr. No	Section No.	A (mm)	B (mm)	T (mm)	Weight(Kg./Mtr)	Weight(Kg./12')
1	6105	44.50	39.50	2.0	0.645	2.360-2.560

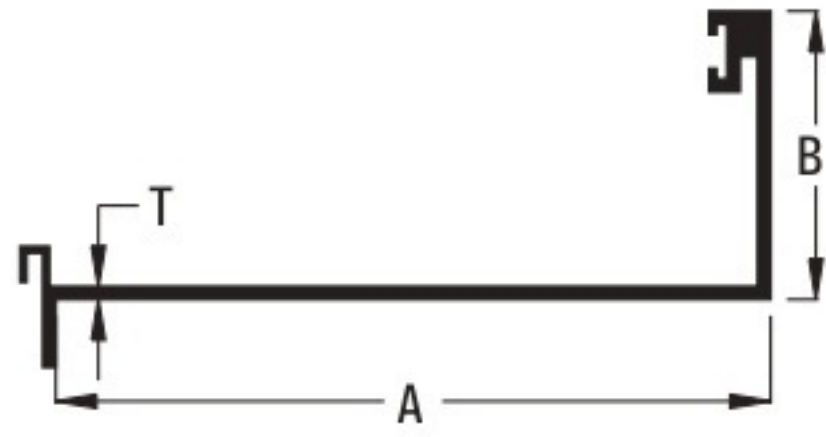

Sr. No	Section No.	A (mm)	B (mm)	T (mm)	Weight(Kg./Mtr)	Weight(Kg./12')
1	6106	110.30	44.5	2.0	1.094	4.000-4.200

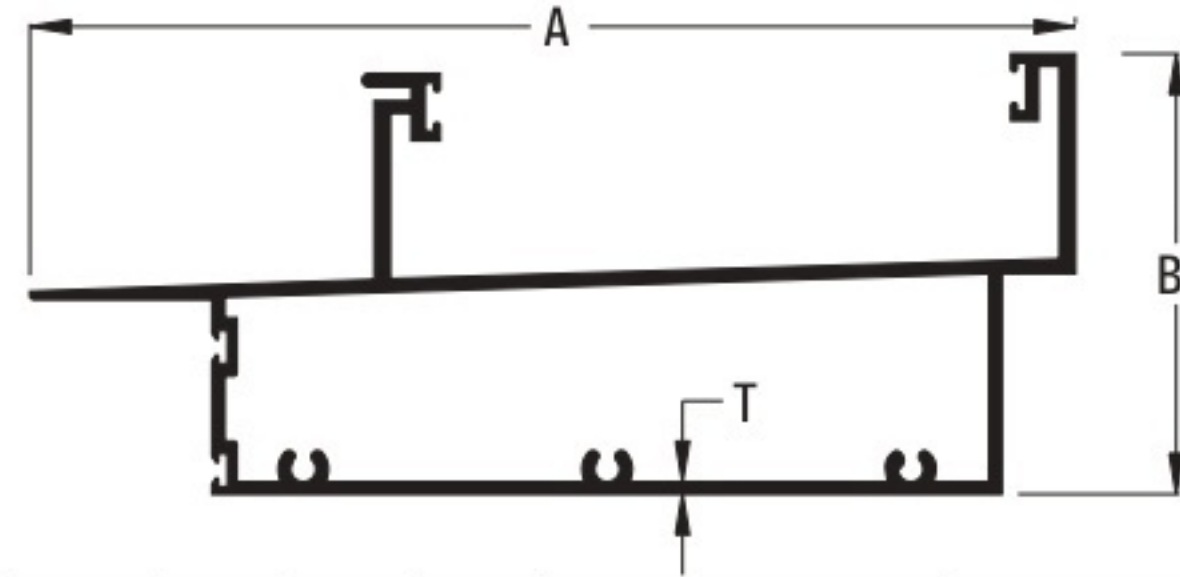

Sr. No	Section No.	A (mm)	B (mm)	T (mm)	Weight(Kg./Mtr)	Weight(Kg./12')
1	6110	172.1	72.5	2.0	2.953	10.800-11.100

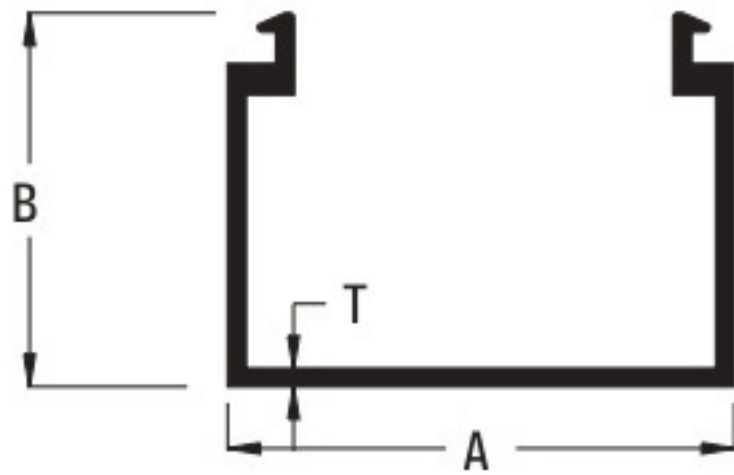

Sr. No	Section No.	A (mm)	B (mm)	T (mm)	Weight(Kg./Mtr)	Weight(Kg./12')
1	6107	27.8	20.51	1.00	0.205	0.750-0.850

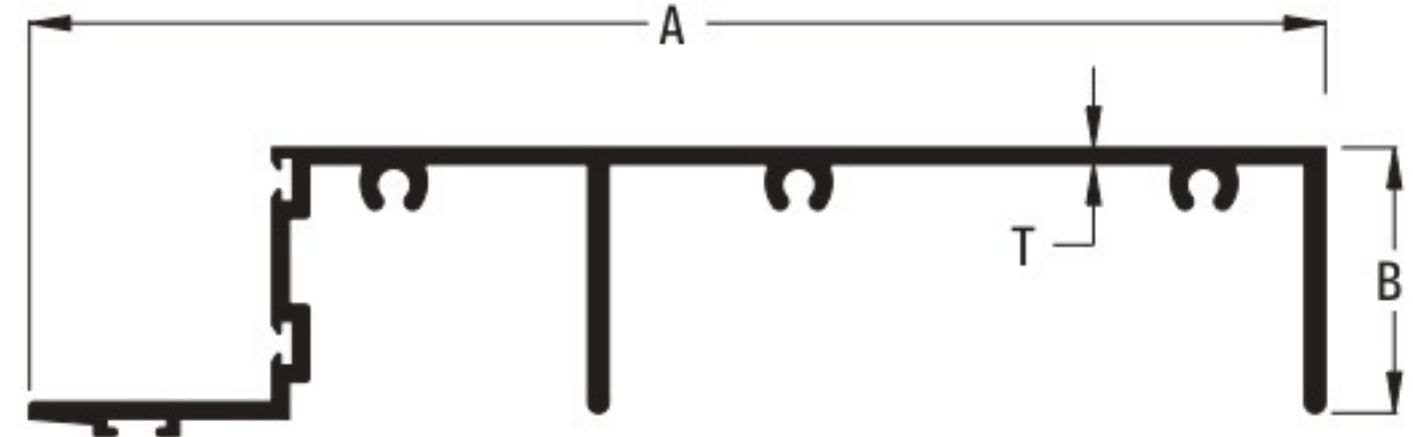

Sr. No	Section No.	A (mm)	B (mm)	T (mm)	Weight(Kg./Mtr)	Weight(Kg./12')
1	6111	160.0	32.80	2.00	1.668	6.100-6.300

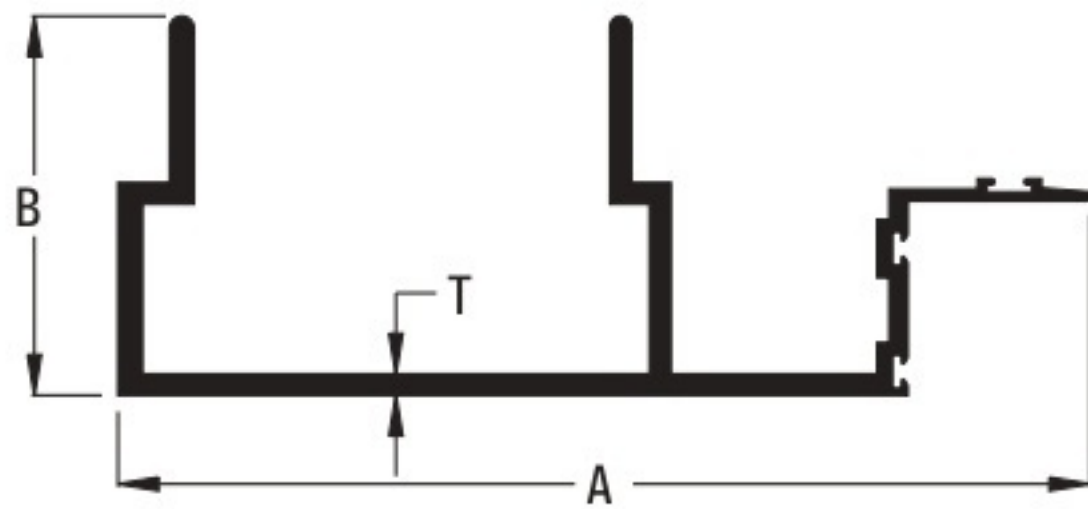

Sr. No	Section No.	A (mm)	B (mm)	T (mm)	Weight(Kg./Mtr)	Weight(Kg./12')
1	6108	160.0	62.4	3.50	2.980	10.900-11.200

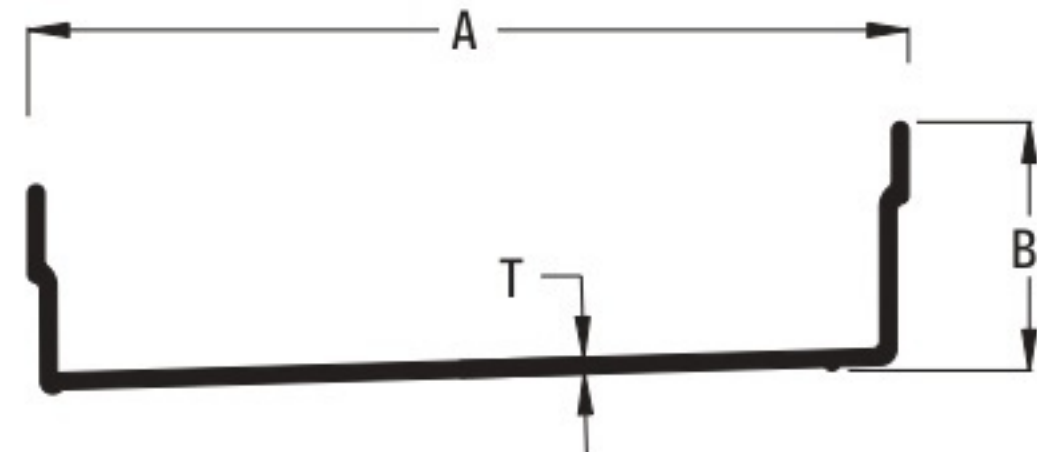

Sr. No	Section No.	A (mm)	B (mm)	T (mm)	Weight(Kg./Mtr)	Weight(Kg./12')
1	6112	108.7	30.70	2.00	0.861	3.150-3.350

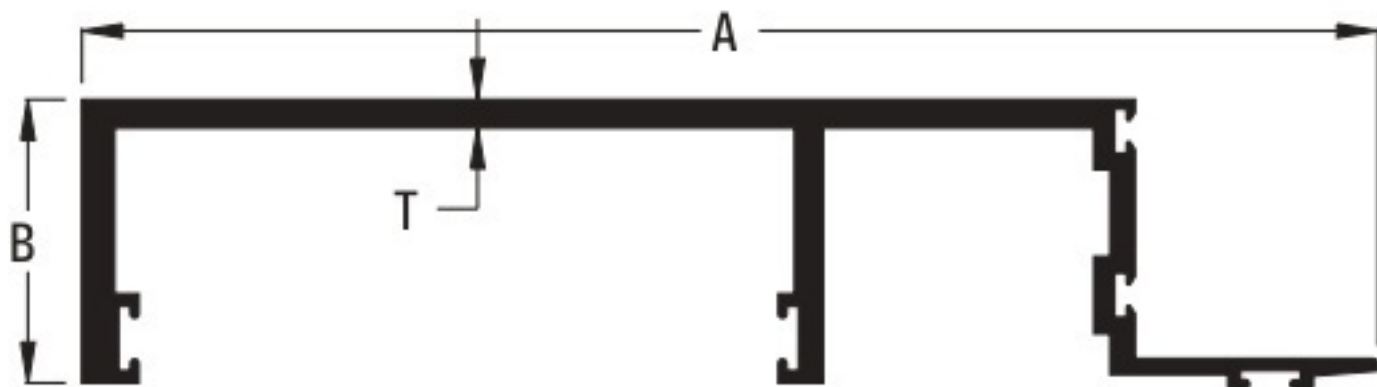

Sr. No	Section No.	A (mm)	B (mm)	T (mm)	Weight(Kg./Mtr)	Weight(Kg./12')
1	6109	160.0	35.0	3.5	2.351	8.600-8.900

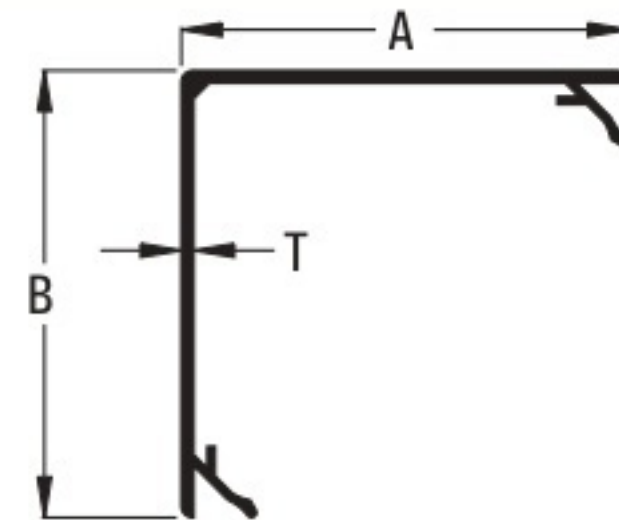

Sr. No	Section No.	A (mm)	B (mm)	T (mm)	Weight(Kg./Mtr)	Weight(Kg./12')
1	6095	57.51	57.51	1.6	0.574	2.100-2.300

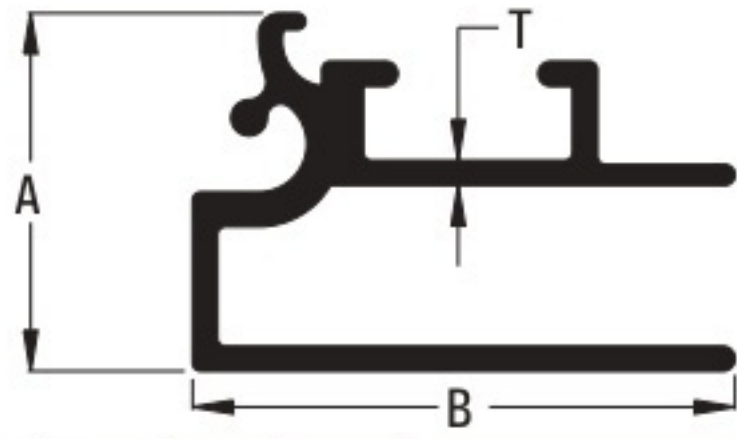

Sr. No	Section No.	A (mm)	B (mm)	T (mm)	Weight(Kg./Mtr)	Weight(Kg./12')
1	6155	22.1	33.5	1.5	0.159	0.580-0.700

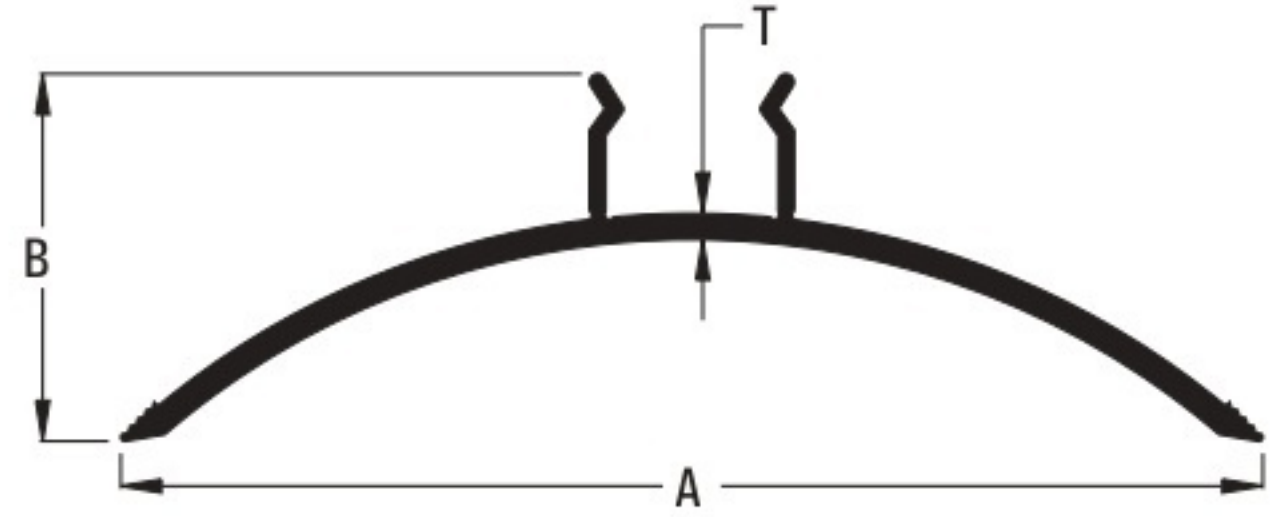

Sr. No	Section No.	A (mm)	B (mm)	T (mm)	Weight(Kg./Mtr)	Weight(Kg./12')
1	6096	70.5	22.7	1.60	0.522	1.910-2.110

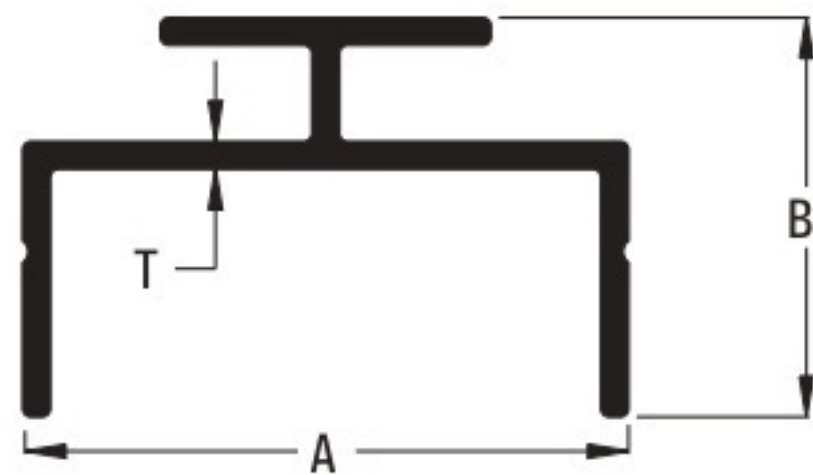

Sr. No	Section No.	A (mm)	B (mm)	T (mm)	Weight(Kg./Mtr)	Weight(Kg./12')
1	6134	37.3	24.7	1.5	0.150	0.550-0.750

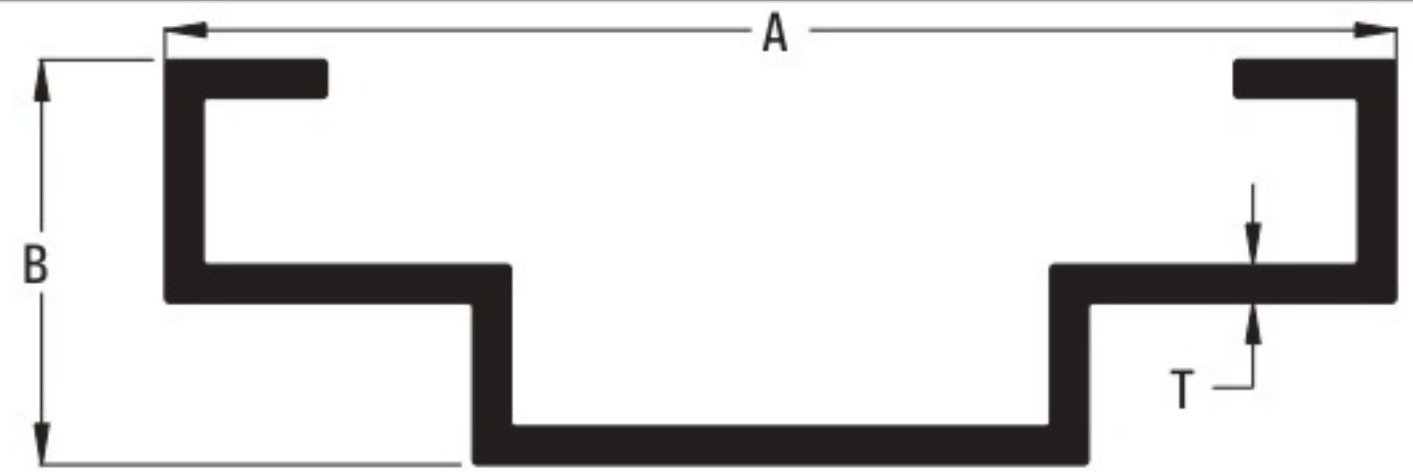

Sr. No	Section No.	A (mm)	B (mm)	T (mm)	Weight(Kg./Mtr)	Weight(Kg./12')
1	6084	114	25	2.35	0.867	3.170-3.370

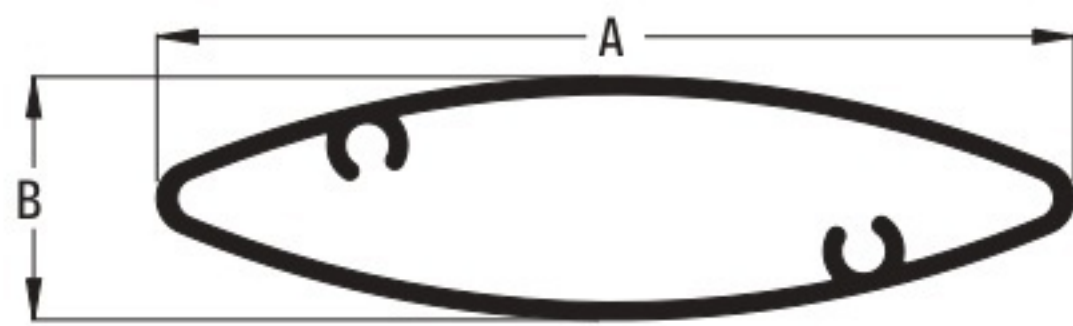

Sr. No	Section No.	A (mm)	B (mm)	T (mm)	Weight(Kg./Mtr)	Weight(Kg./12')
1	6150	56.6	15	...	0.656	2.400-2.600

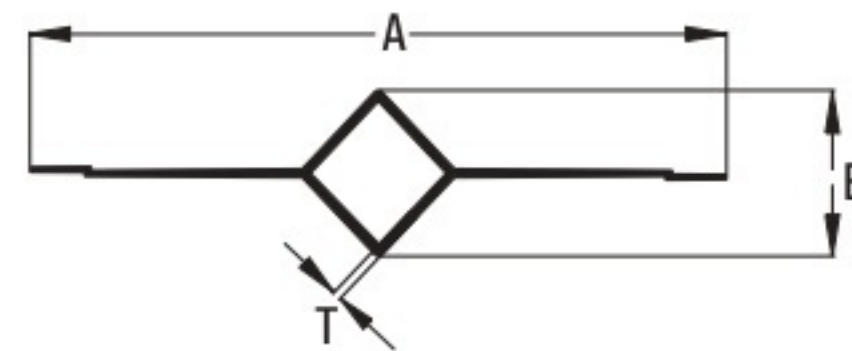

Sr. No	Section No.	A (mm)	B (mm)	T (mm)	Weight(Kg./Mtr)	Weight(Kg./12')
1	6007	159.5	38	2.0	1.053	3.850-4.050

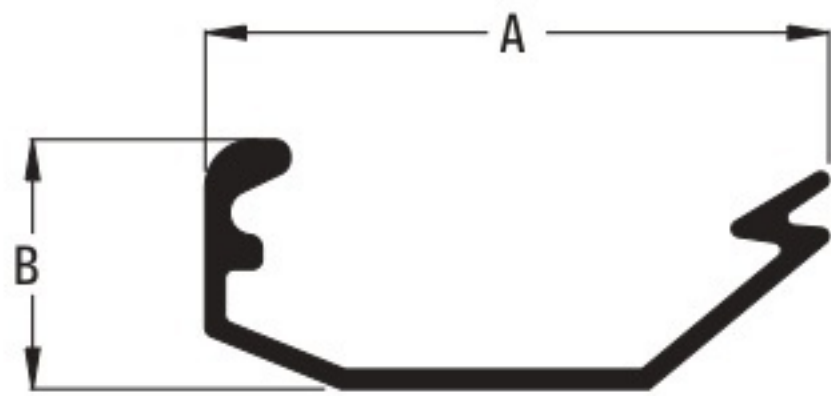

Sr. No	Section No.	A (mm)	B (mm)	T (mm)	Weight(Kg./Mtr)	Weight(Kg./12')
1	6154	38.5	15.4	...	0.070	0.225-0.325

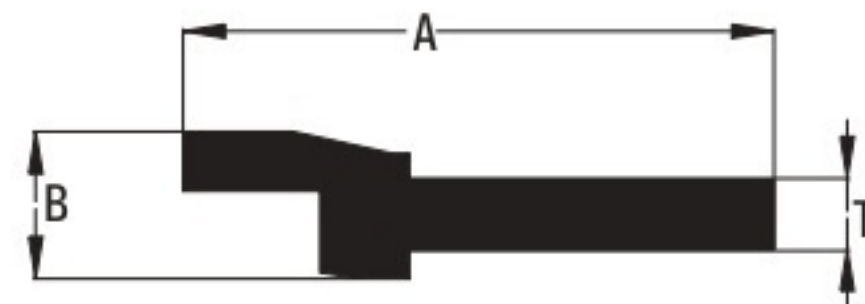

Sr. No	Section No.	A (mm)	B (mm)	T (mm)	Weight(Kg./Mtr)	Weight(Kg./12')
1	6008	47.4	11.8	5.8	0.793	2.900-3.100

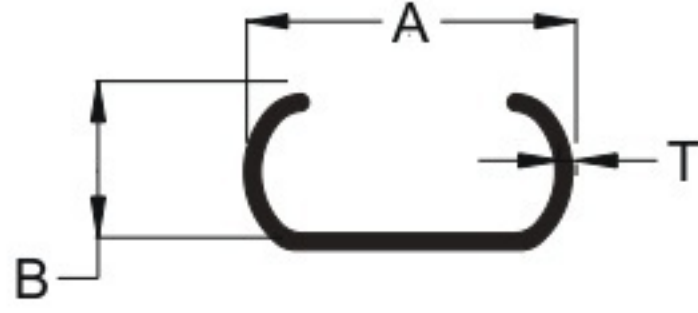

Sr. No	Section No.	A (mm)	B (mm)	T (mm)	Weight(Kg./Mtr)	Weight(Kg./12')
1	6009	66.5	31.6	3.35	1.094	4.000-4.300

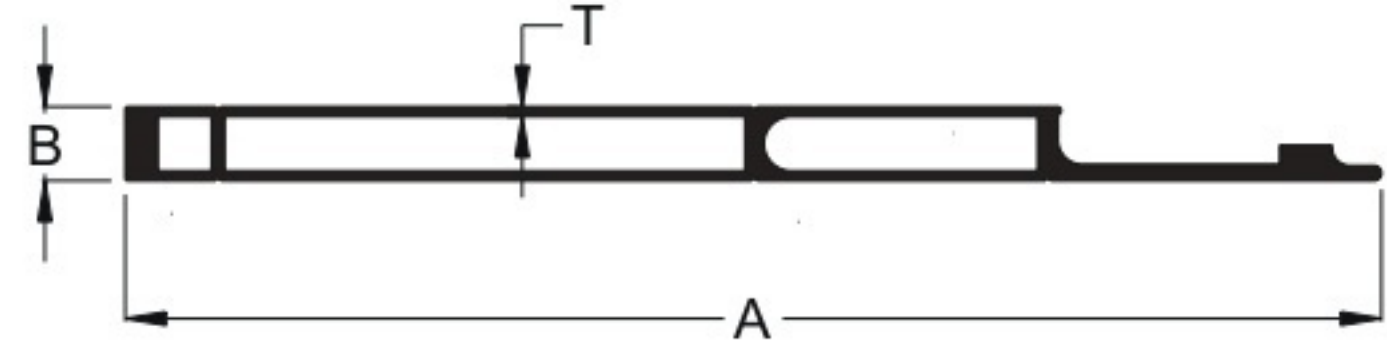

Sr. No	Section No.	A (mm)	B (mm)	T (mm)	Weight(Kg./Mtr)	Weight(Kg./12')
1	6191	154.5	9.10	1.20	0.719	2.630 - 2.830

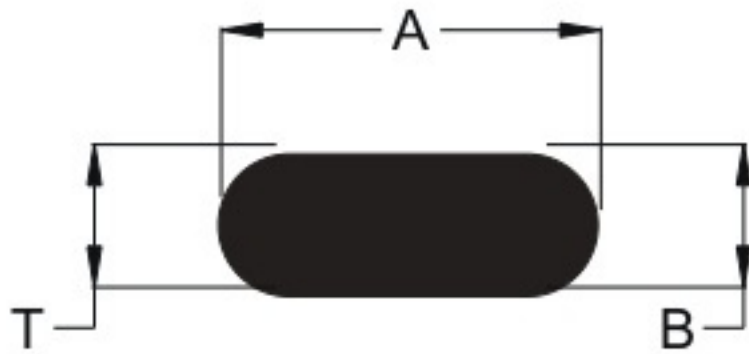

Sr. No	Section No.	A (mm)	B (mm)	T (mm)	Weight(Kg./Mtr)	Weight(Kg./12')
1	6010	16	6	6	0.238	0.870-0.970

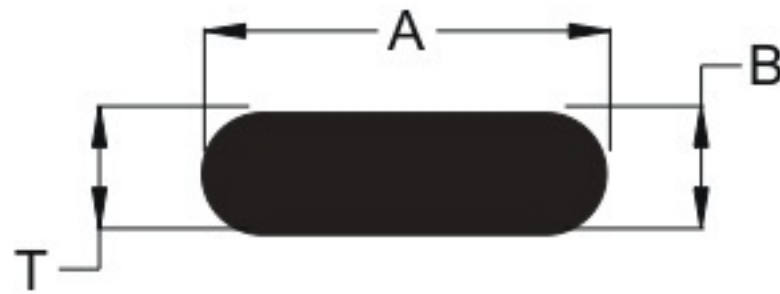

Sr. No	Section No.	A (mm)	B (mm)	T (mm)	Weight(Kg./Mtr)	Weight(Kg./12')
1	6011	19.9	6	6	0.301	1.100-1.200



Sr. No	Section No.	A (mm)	B (mm)	T (mm)	Weight(Kg./Mtr)	Weight(Kg./12')
1	6016	64.8	0.8	0.139	0.510-0.610

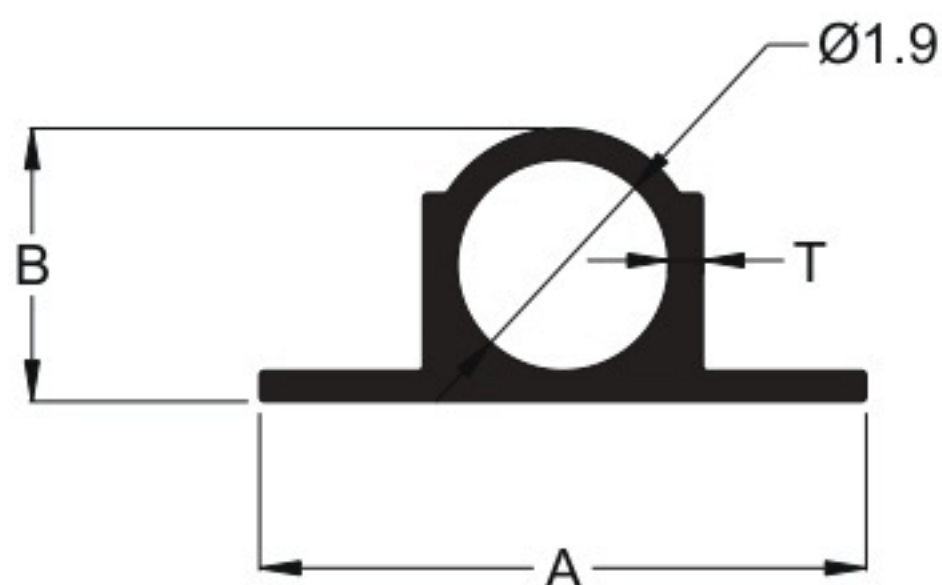

Sr. No	Section No.	A (mm)	B (mm)	T (mm)	Weight(Kg./Mtr)	Weight(Kg./12')
1	1722	37.3	15.2	2.10	0.448	1.640 - 1.840



Sr. No	Section No.	A (mm)	B (mm)	T (mm)	Weight(Kg./Mtr)	Weight(Kg./12')
1	6017	79.75	0.8	0.172	0.630-0.730

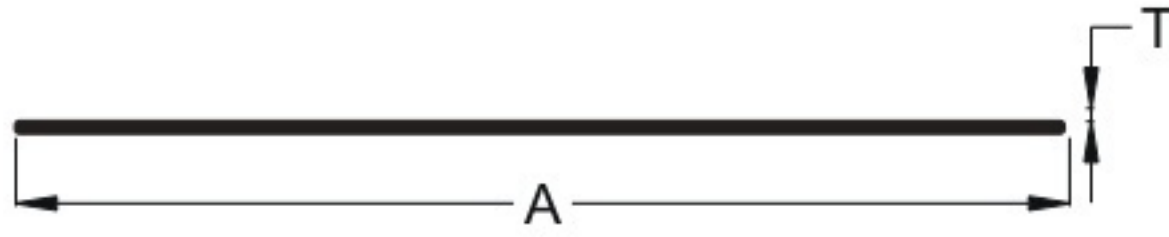

Sr. No	Section No.	A (mm)	B (mm)	T (mm)	Weight(Kg./Mtr)	Weight(Kg./12')
1	6018	97.60	----	0.8	0.210	0.770-0.870

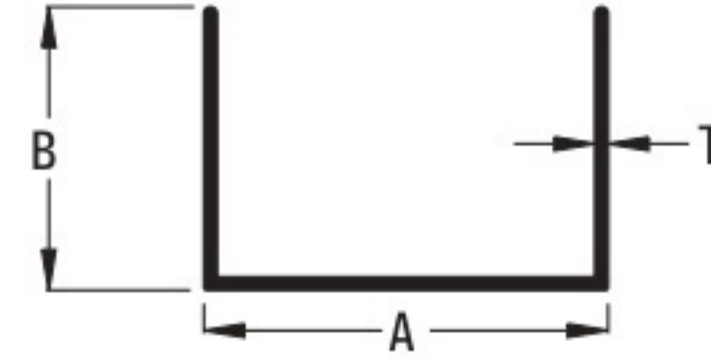

Sr. No	Section No.	A (mm)	B (mm)	T (mm)	Weight(Kg./Mtr)	Weight(Kg./12')
1	6022	42.8	30.0	1.4	0.369	1.350-1.450

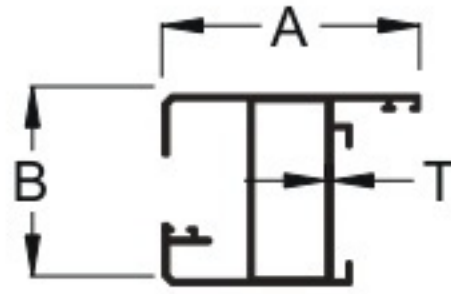

Sr. No	Section No.	A (mm)	B (mm)	T (mm)	Weight(Kg./Mtr)	Weight(Kg./12')
1	6019	54	40	1.5	0.806	2.950-3.150

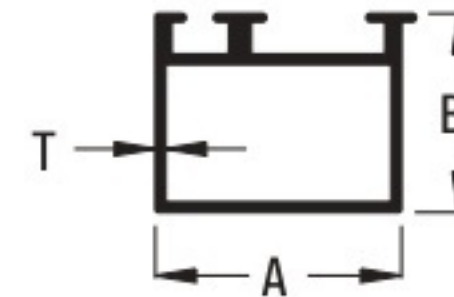

Sr. No	Section No.	A (mm)	B (mm)	T (mm)	Weight(Kg./Mtr)	Weight(Kg./12')
1	6023	26.6	21.5	1.1	0.336	1.230-1.430

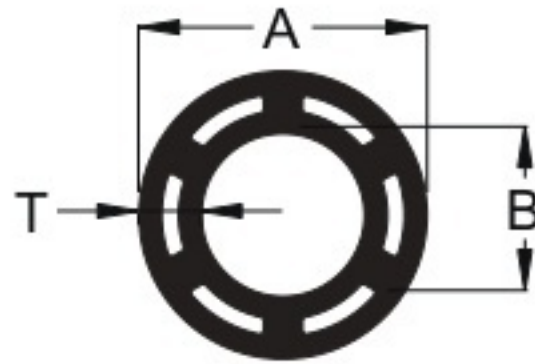

Sr. No	Section No.	A (mm)	B (mm)	T (mm)	Weight(Kg./Mtr)	Weight(Kg./12')
1	3969/A	67.0	38.0	14.5	5.277	19.300-19.600

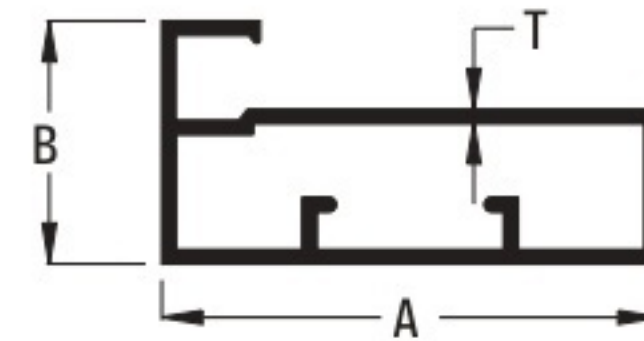

Sr. No	Section No.	A (mm)	B (mm)	T (mm)	Weight(Kg./Mtr)	Weight(Kg./12')
1	6024	45.0	22.0	1.3	0.481	1.760-2.000

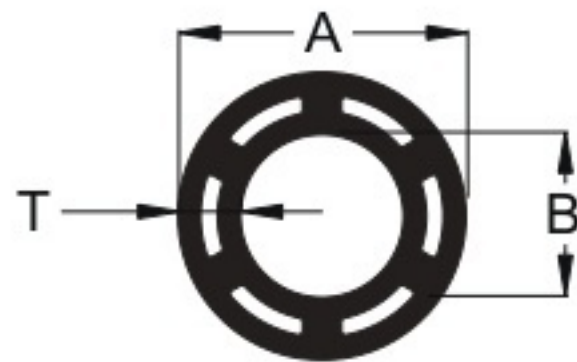

Sr. No	Section No.	A (mm)	B (mm)	T (mm)	Weight(Kg./Mtr)	Weight(Kg./12')
1	3969	71.0	38.0	16.0	6.471	23.670-24.170

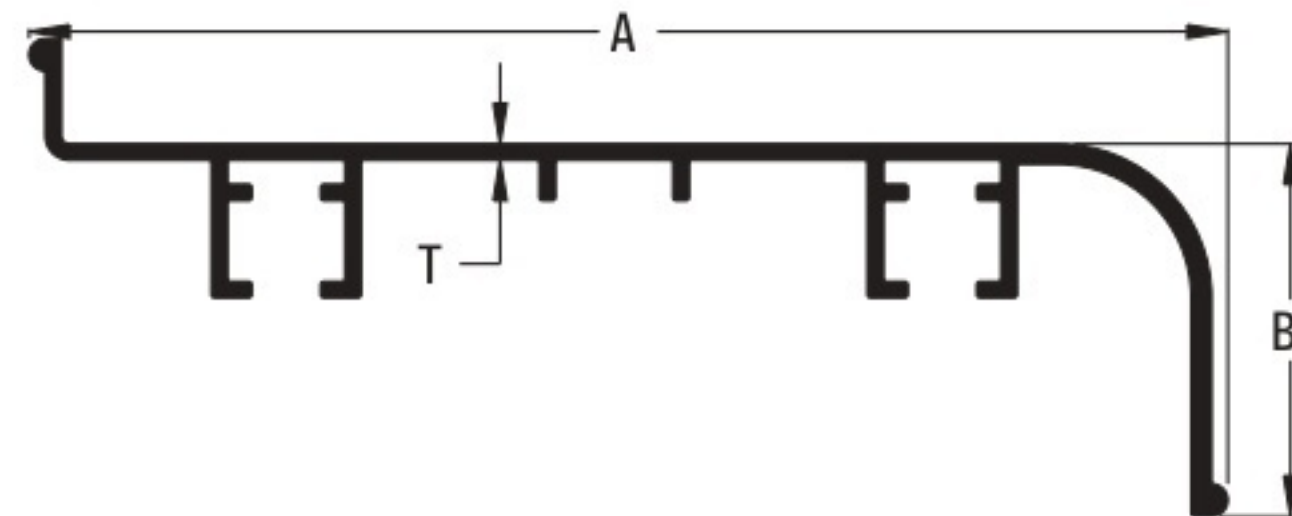

Sr. No	Section No.	A (mm)	B (mm)	T (mm)	Weight(Kg./Mtr)	Weight(Kg./12')
1	6025	148.0	46.0	2.0	1.695	6.200-6.500

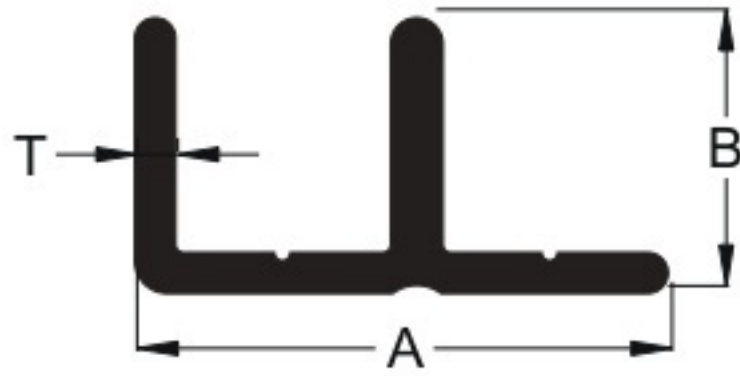

Sr. No	Section No.	A (mm)	B (mm)	T (mm)	Weight(Kg./Mtr)	Weight(Kg./12')
1	6026	32.9	17.0	2.5	0.432	1.580-1.780

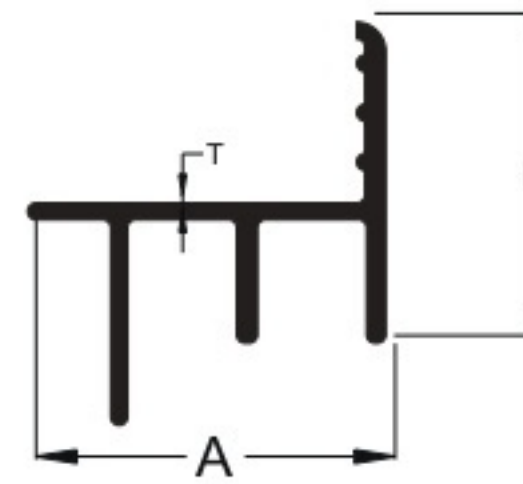

Sr. No	Section No.	A (mm)	B (mm)	T (mm)	Weight(Kg./Mtr)	Weight(Kg./12')
1	6030	43.5	39.0	2.0	0.723	2.645-2.845

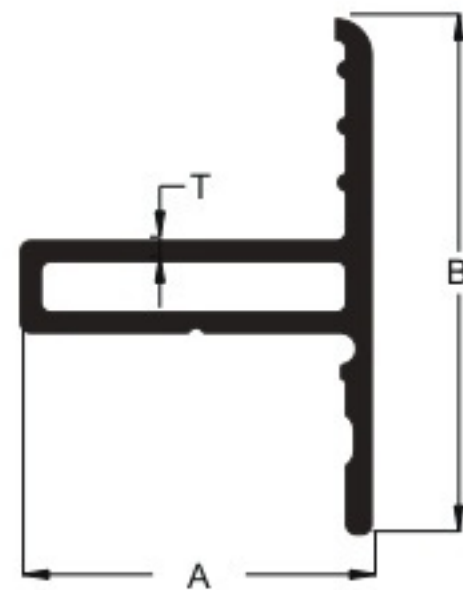

Sr. No	Section No.	A (mm)	B (mm)	T (mm)	Weight(Kg./Mtr)	Weight(Kg./12')
1	6027	34.8	51.1	2.0	0.711	2.600-2.800

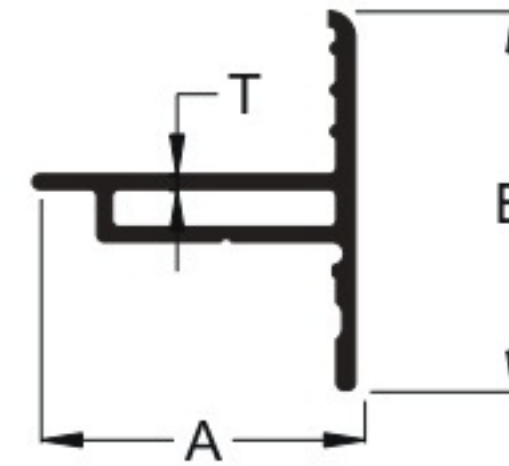

Sr. No	Section No.	A (mm)	B (mm)	T (mm)	Weight(Kg./Mtr)	Weight(Kg./12')
1	6031	43.5	51.1	2.0	0.761	2.785-3.000

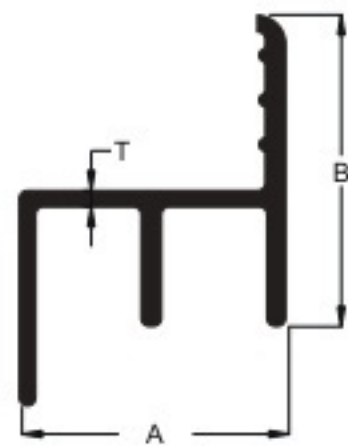

Sr. No	Section No.	A (mm)	B (mm)	T (mm)	Weight(Kg./Mtr)	Weight(Kg./12')
1	6028	33.4	39.0	2.0	0.656	2.430-2.630

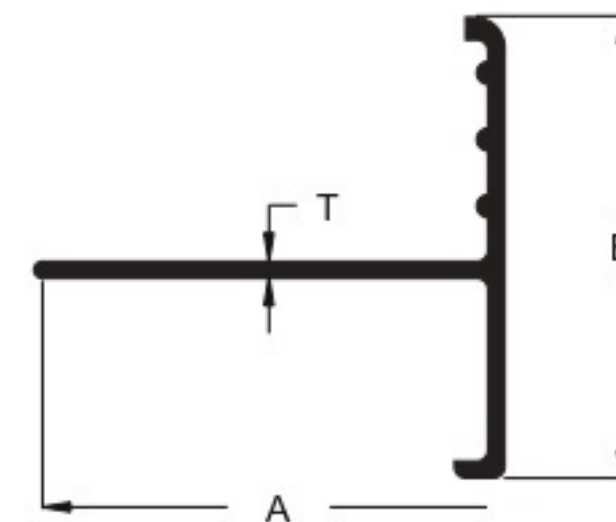

Sr. No	Section No.	A (mm)	B (mm)	T (mm)	Weight(Kg./Mtr)	Weight(Kg./12')
1	6032	42.4	41.5	1.5	0.355	1.300-1.500

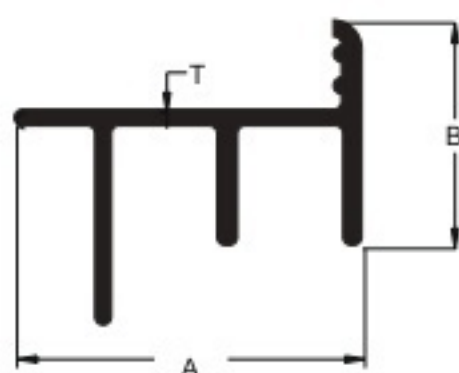

Sr. No	Section No.	A (mm)	B (mm)	T (mm)	Weight(Kg./Mtr)	Weight(Kg./12')
1	6029	43.5	28.2	2.0	1.695	6.200-6.500

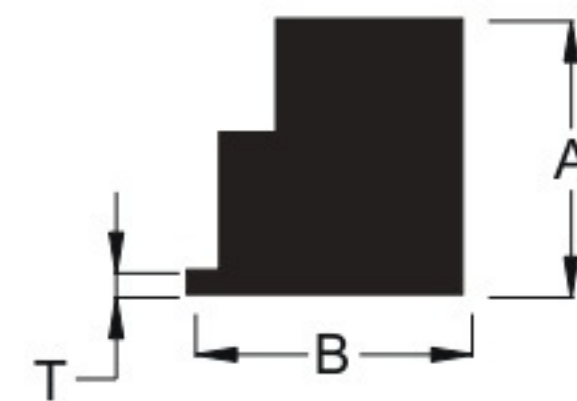

Sr. No	Section No.	A (mm)	B (mm)	T (mm)	Weight(Kg./Mtr)	Weight(Kg./12')
1	6033	34.0	34.0	3.0	2.253	9.230-9.430

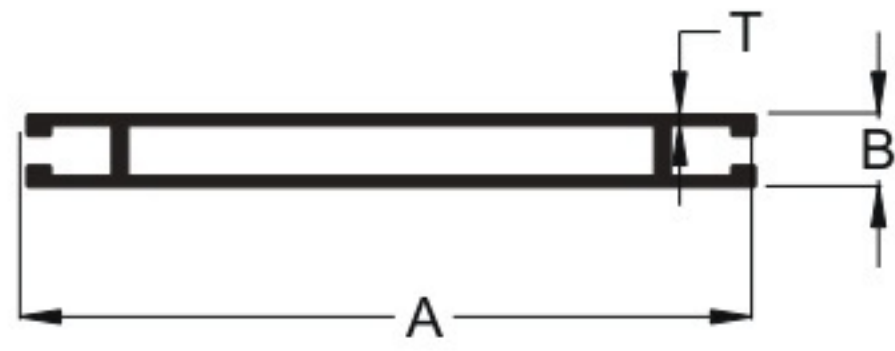

Sr. No	Section No.	A (mm)	B (mm)	T (mm)	Weight(Kg./Mtr)	Weight(Kg./12')
1	6034	45.0	9.0	1.4	0.793	2.900-3.100

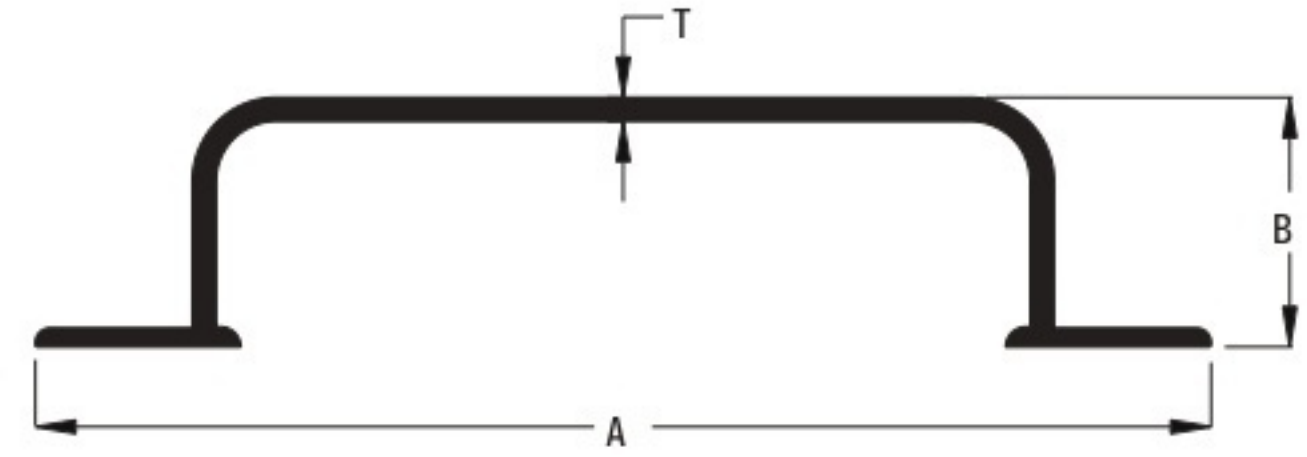

Sr. No	Section No.	A (mm)	B (mm)	T (mm)	Weight(Kg./Mtr)	Weight(Kg./12')
1	6194	146.0	31.0	2.95	1.613	5.550-5.900

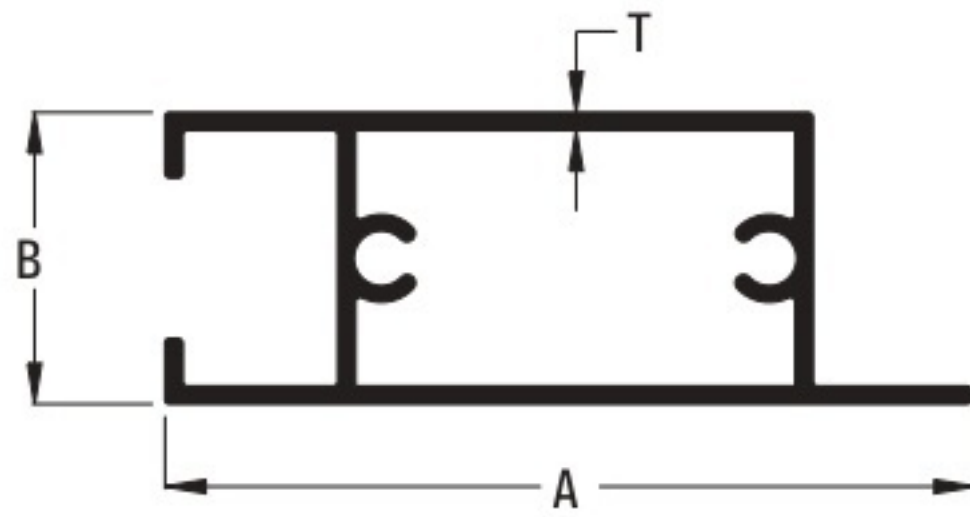

Sr. No	Section No.	A (mm)	B (mm)	T (mm)	Weight(Kg./Mtr)	Weight(Kg./12')
1	6085	50	18	1.1	0.424	1.550-1.700

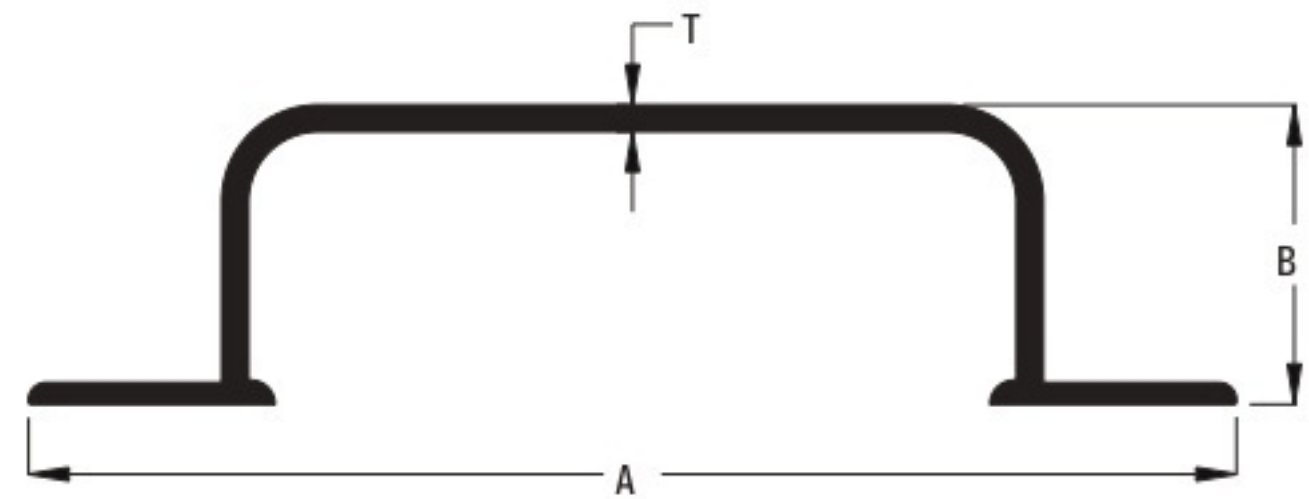

Sr. No	Section No.	A (mm)	B (mm)	T (mm)	Weight(Kg./Mtr)	Weight(Kg./12')
1	6176	125.0	31.0	2.8	1.312	4.600-4.800

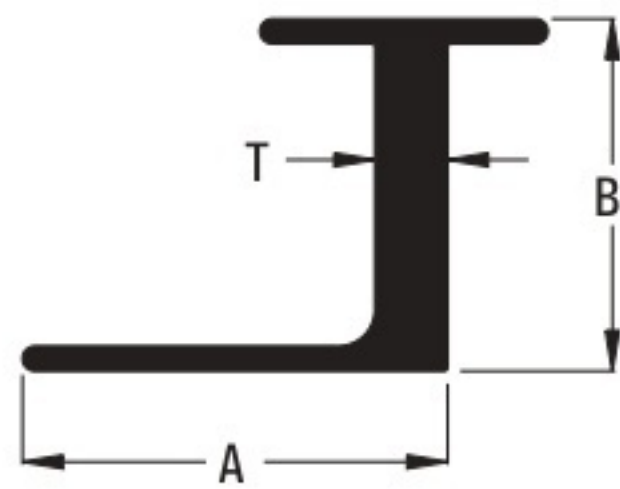

Sr. No	Section No.	A (mm)	B (mm)	T (mm)	Weight(Kg./Mtr)	Weight(Kg./12')
1	6037	35.0	29.0	6.0	0.729	2.670-2.870

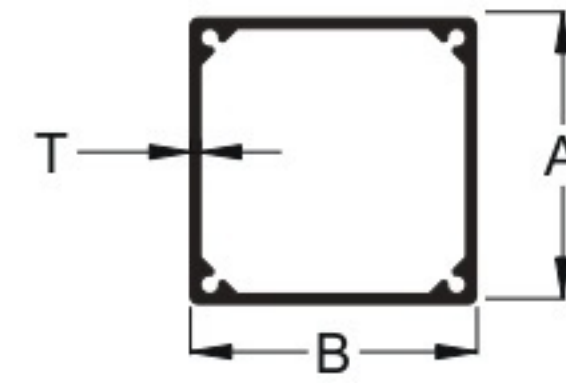

Sr. No	Section No.	A (mm)	B (mm)	T (mm)	Weight(Kg./Mtr)	Weight(Kg./12')
1	6041	70.5	70.5	2.4	1.982	7.250-7.450

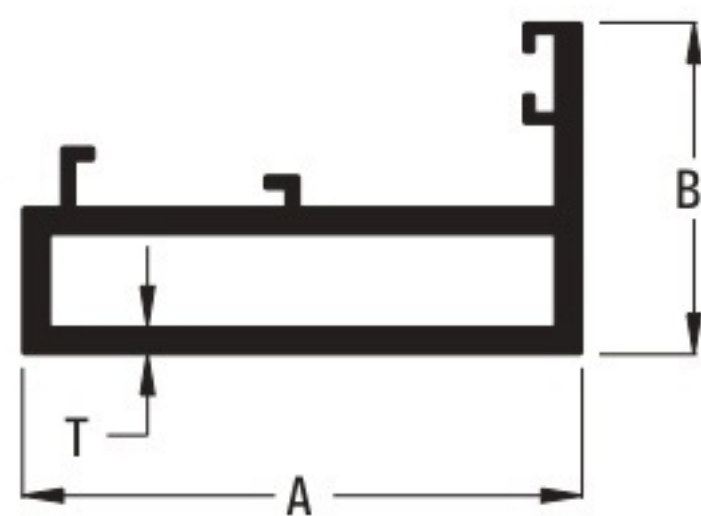

Sr. No	Section No.	A (mm)	B (mm)	T (mm)	Weight(Kg./Mtr)	Weight(Kg./12')
1	6038	61.4	36.4	3.0	0.422	5.200-5.400

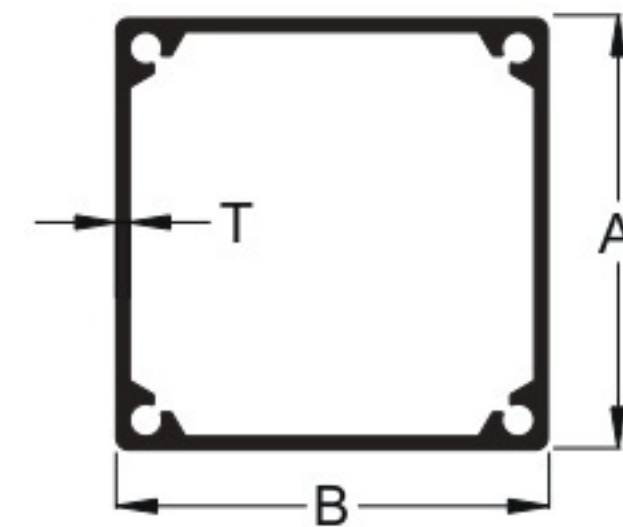

Sr. No	Section No.	A (mm)	B (mm)	T (mm)	Weight(Kg./Mtr)	Weight(Kg./12')
1	6042	106.5	106.5	3.0	4.224	15.450-15.650

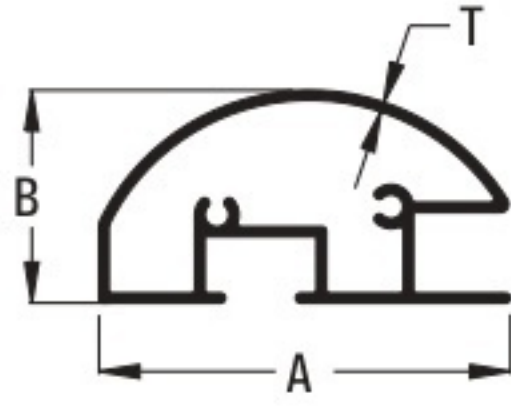

Sr. No	Section No.	A (mm)	B (mm)	T (mm)	Weight(Kg./Mtr)	Weight(Kg./12')
1	6043	50.8	26.3	1.2	0.585	2.140-2.340

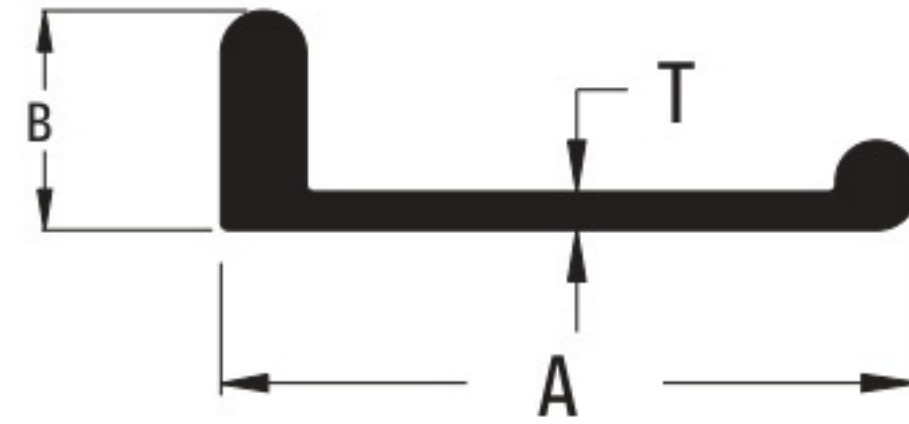

Sr. No	Section No.	A (mm)	B (mm)	T (mm)	Weight(Kg./Mtr)	Weight(Kg./12')
1	6062	27.30	8.50	1.5	0.184	0.675-0.775

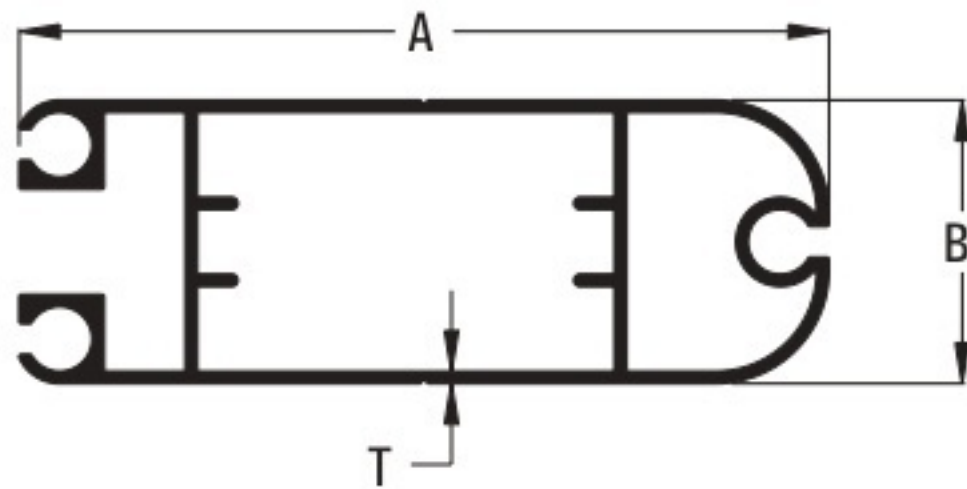

Sr. No	Section No.	A (mm)	B (mm)	T (mm)	Weight(Kg./Mtr)	Weight(Kg./12')
1	6045	100	35.0	1.5	1.531	5.600-5.800

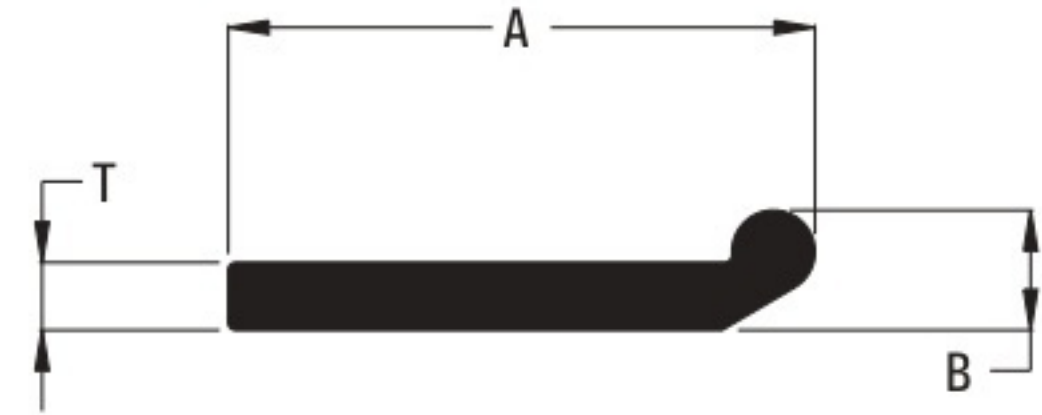

Sr. No	Section No.	A (mm)	B (mm)	T (mm)	Weight(Kg./Mtr)	Weight(Kg./12')
1	6063	23.0	4.7	2.7	0.168	0.615-0.715

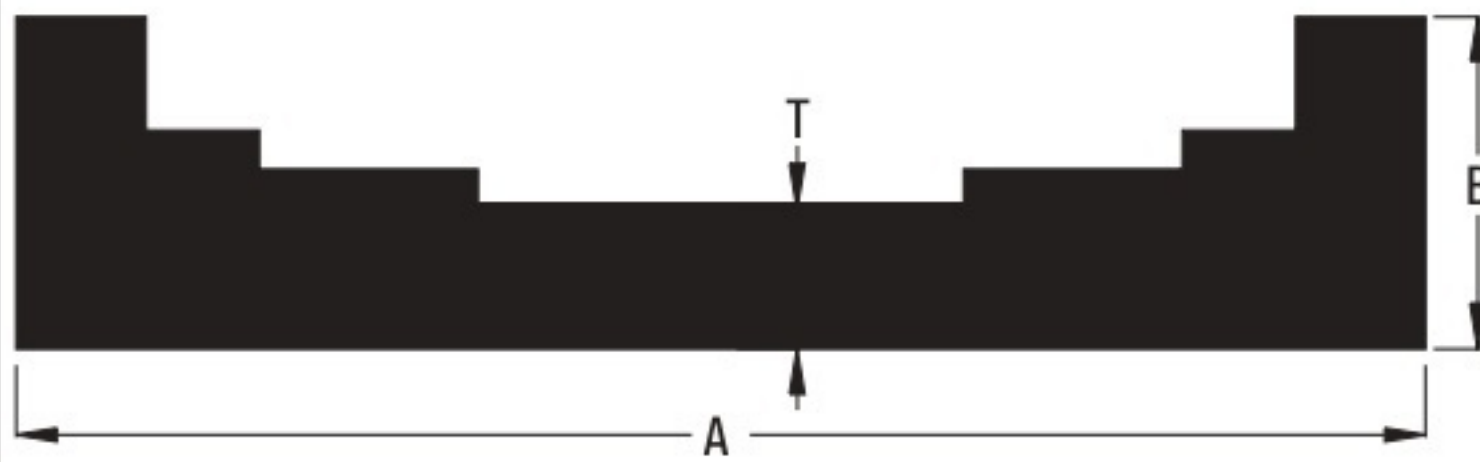

Sr. No	Section No.	A (mm)	B (mm)	T (mm)	Weight(Kg./Mtr)	Weight(Kg./12')
1	6060	174.0	41.0	18.0	11.756	43.000-45.000

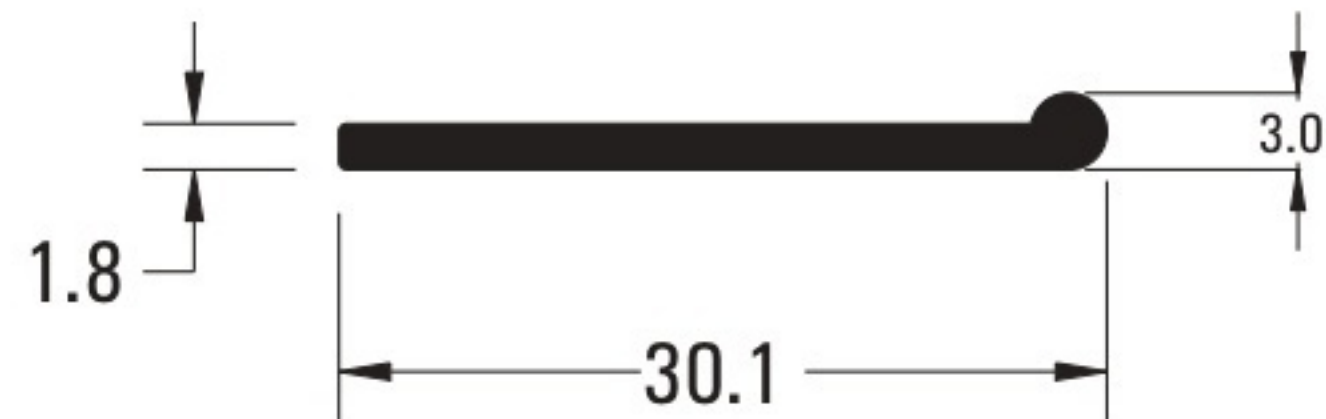

Sr. No	Section No.	A (mm)	B (mm)	T (mm)	Weight(Kg./Mtr)	Weight(Kg./12')
1	6064	30.10	3.0	1.8	0.152	0.555-0.655

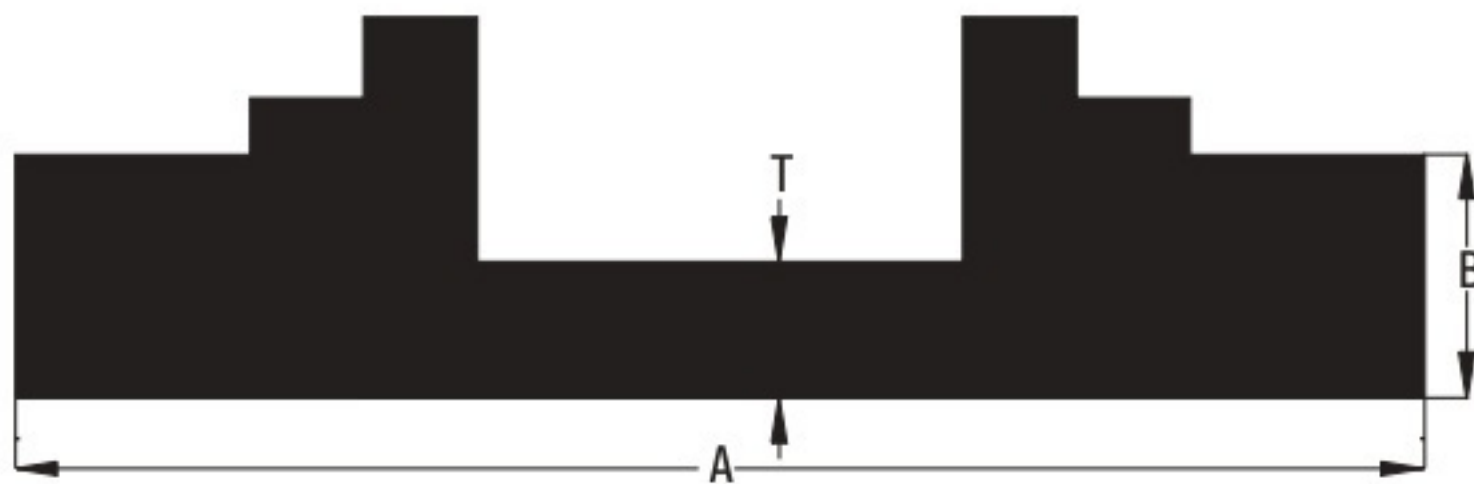

Sr. No	Section No.	A (mm)	B (mm)	T (mm)	Weight(Kg./Mtr)	Weight(Kg./12')
1	6061	174.0	30.0	16.80	13.779	50.400-52.400

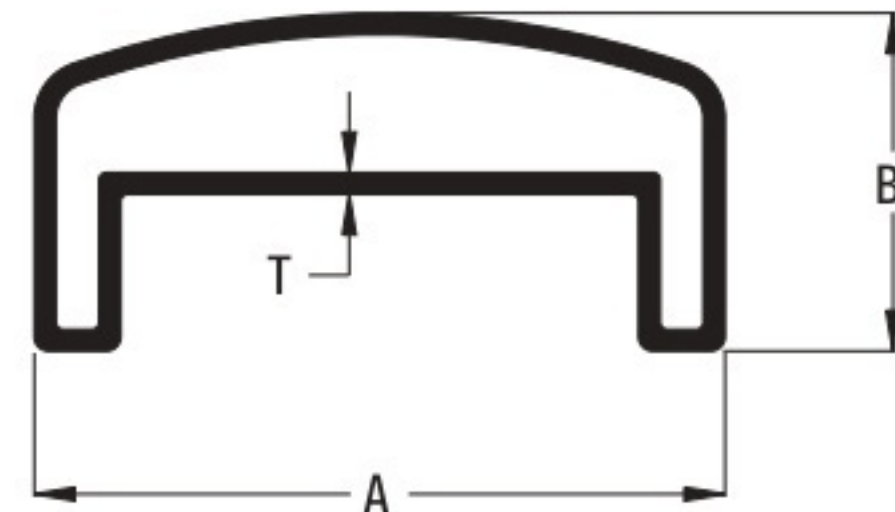

Sr. No	Section No.	A (mm)	B (mm)	T (mm)	Weight(Kg./Mtr)	Weight(Kg./12')
1	2482	48.48	23.73	1.5	0.601	2.200-2.400

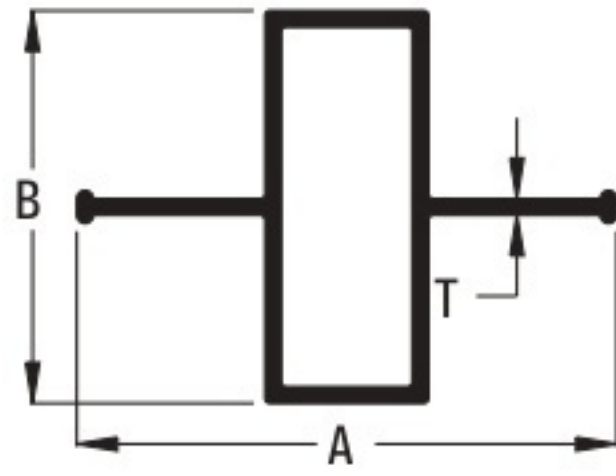

Sr. No	Section No.	A (mm)	B (mm)	T (mm)	Weight(Kg./Mtr)	Weight(Kg./12')
1	6066	33.0	24.0	1.0	0.238	0.870-0.970

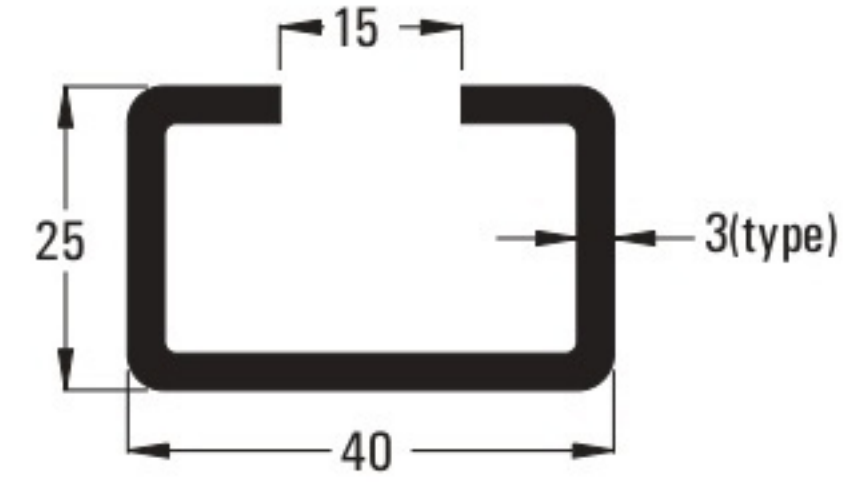

Sr. No	Section No.	A (mm)	B (mm)	T (mm)	Weight(Kg./Mtr)	Weight(Kg./12')
1	6070	40.0	25.0	3.0	0.820	3.000-3.200

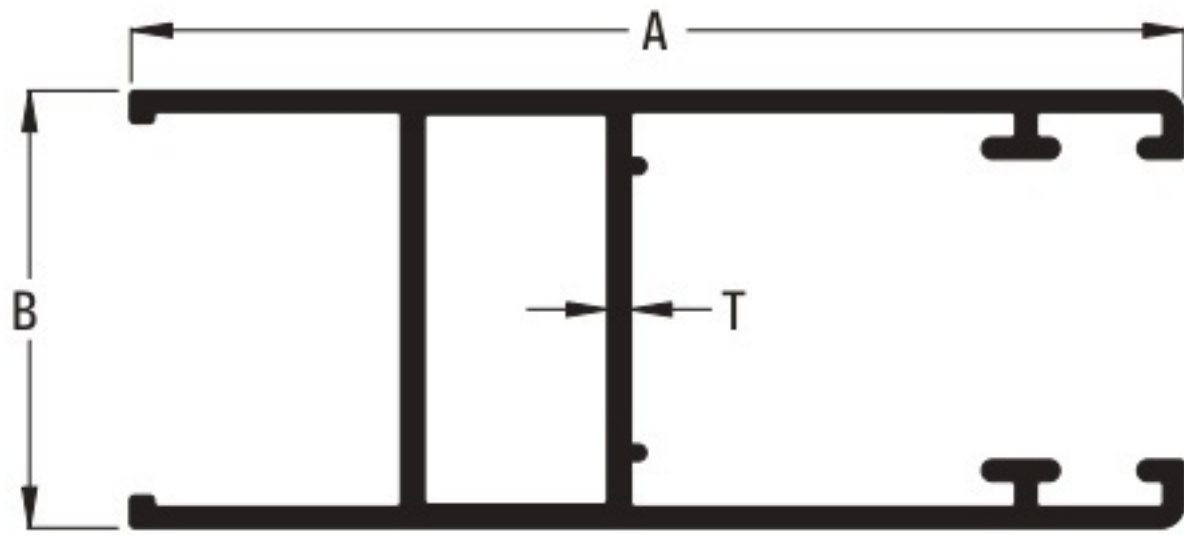

Sr. No	Section No.	A (mm)	B (mm)	T (mm)	Weight(Kg./Mtr)	Weight(Kg./12')
1	6087	65	27	1.5	0.765	2.800-3.000

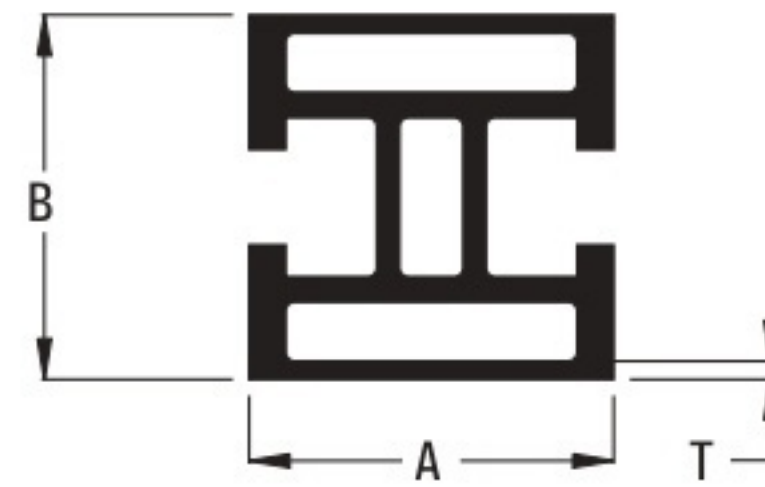

Sr. No	Section No.	A (mm)	B (mm)	T (mm)	Weight(Kg./Mtr)	Weight(Kg./12')
1	6071	40.0	40.0	2.0	1.709	6.250-6.450

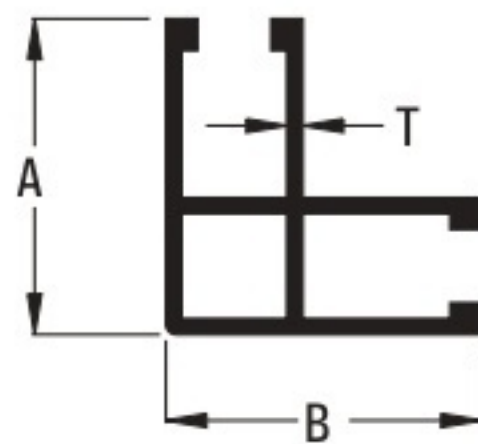

Sr. No	Section No.	A (mm)	B (mm)	T (mm)	Weight(Kg./Mtr)	Weight(Kg./12')
1	4520	30	30	1.5	0.509	1.865-2.065



Sr. No	Section No.	A (mm)	B (mm)	T (mm)	Weight(Kg./Mtr)	Weight(Kg./12')
1	6072	176.45	19.0	---	9.049	33.100-34.000



Sr. No	Section No.	A (mm)	B (mm)	T (mm)	Weight(Kg./Mtr)	Weight(Kg./12')
1	6069	66.50	22.0	1.25	0.640	2.340-2.540

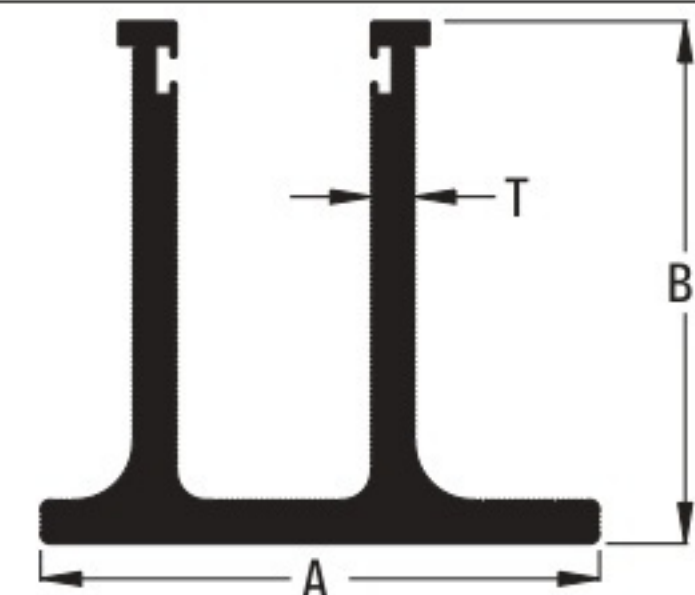

Sr. No	Section No.	A (mm)	B (mm)	T (mm)	Weight(Kg./Mtr)	Weight(Kg./12')
1	6097	115	107.5	9	7.423	27.150-27.450

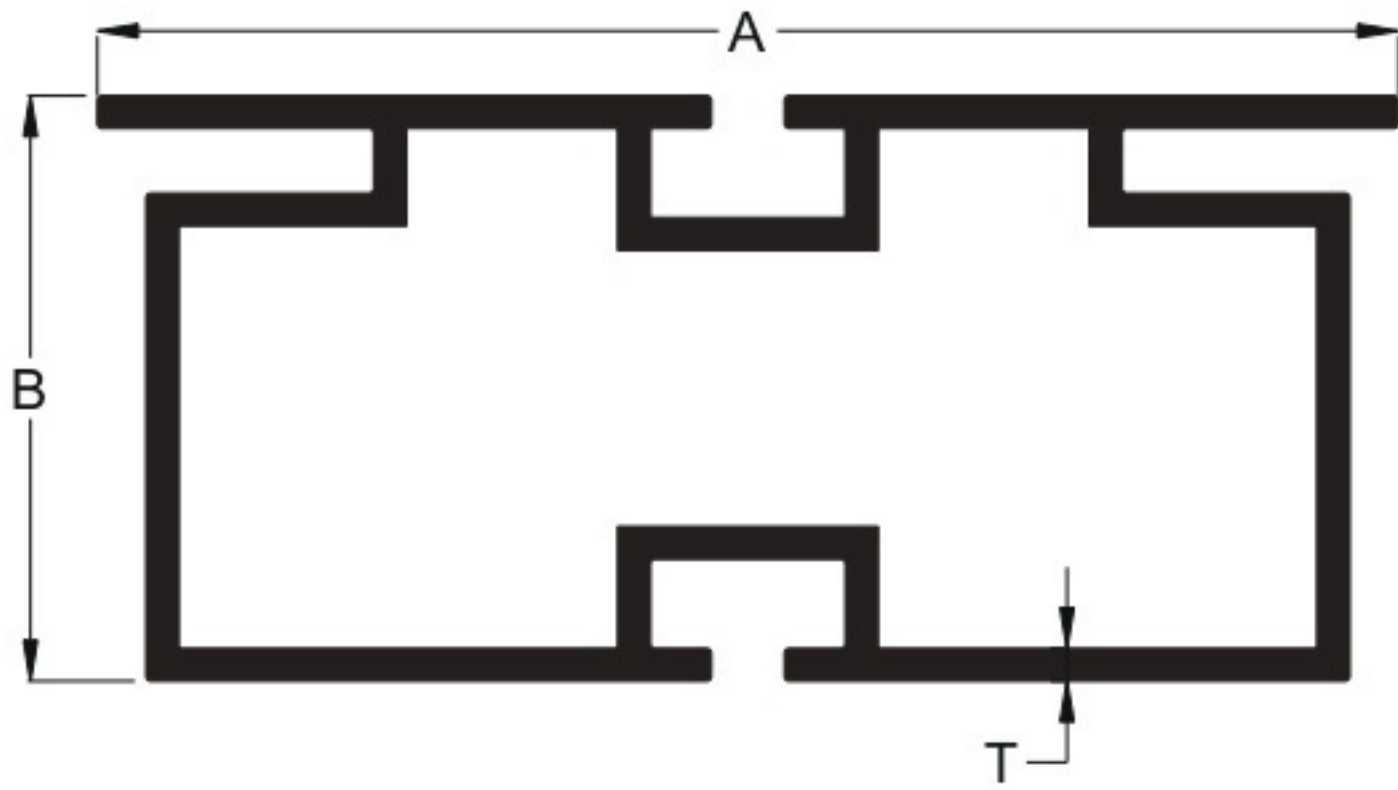

Sr. No	Section No.	A (mm)	B (mm)	T (mm)	Weight(Kg./Mtr)	Weight(Kg./12')
1	6151	80	36.0	2	2.283	8.350-8.650

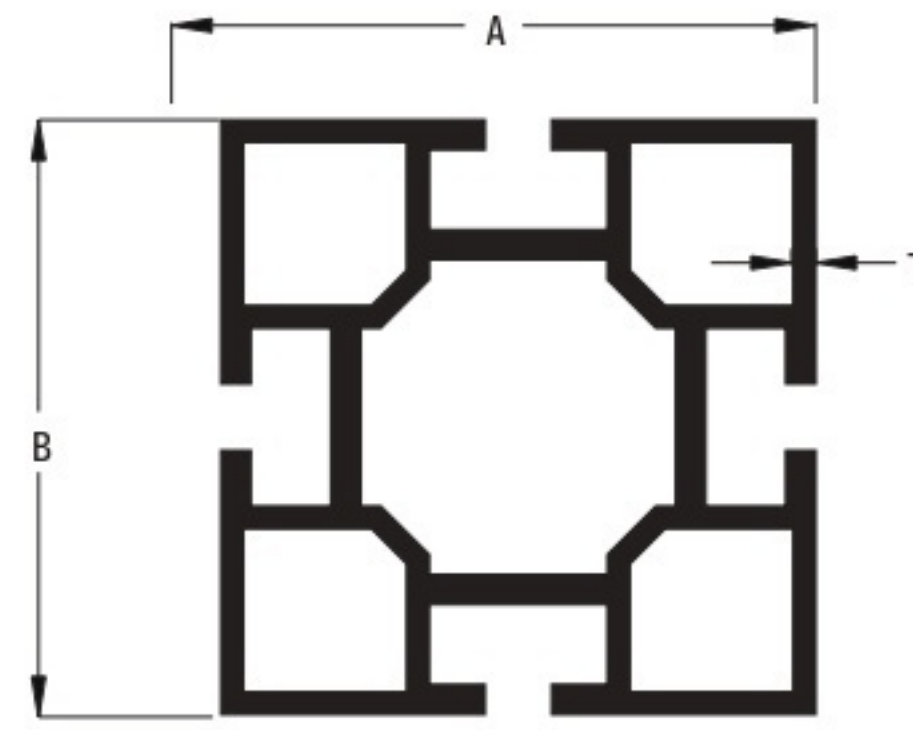

Sr. No	Section No.	A (mm)	B (mm)	T (mm)	Weight(Kg./Mtr)	Weight(Kg./12')
1	6175	40.0	40.0	1.50	1.191	4.355-4.500

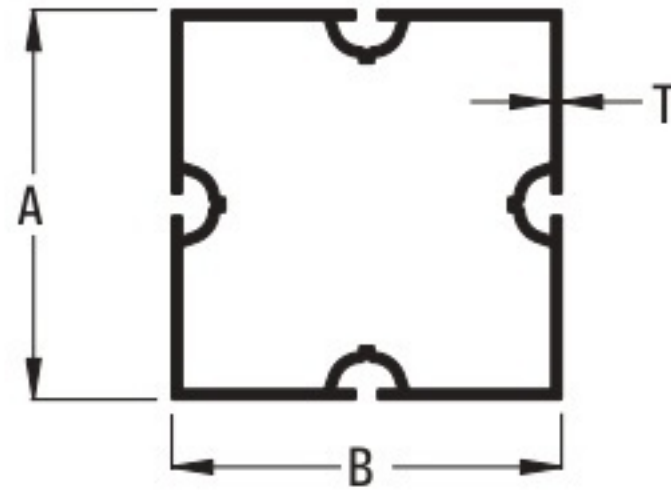

Sr. No	Section No.	A (mm)	B (mm)	T (mm)	Weight(Kg./Mtr)	Weight(Kg./12')
1	6152	80.2	80.2	2.10	2.187	8.000-8.300

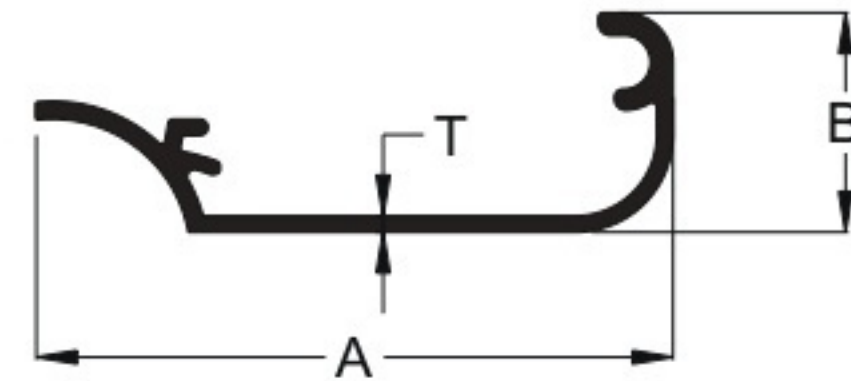

Sr. No	Section No.	A (mm)	B (mm)	T (mm)	Weight(Kg./Mtr)	Weight(Kg./12')
1	6180	39.2	13.5	1.0	0.184	0.675 - 0.800

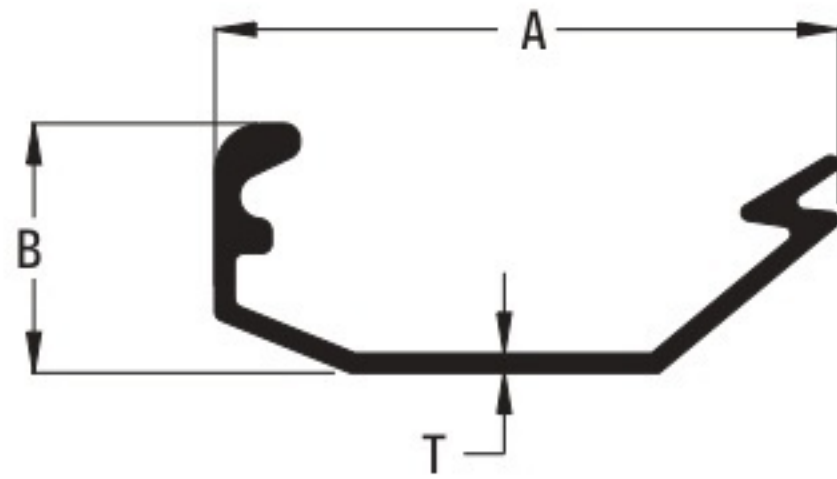

Sr. No	Section No.	A (mm)	B (mm)	T (mm)	Weight(Kg./Mtr)	Weight(Kg./12')
1	6154	19.20	7.7	0.6	0.062	0.225-0.325

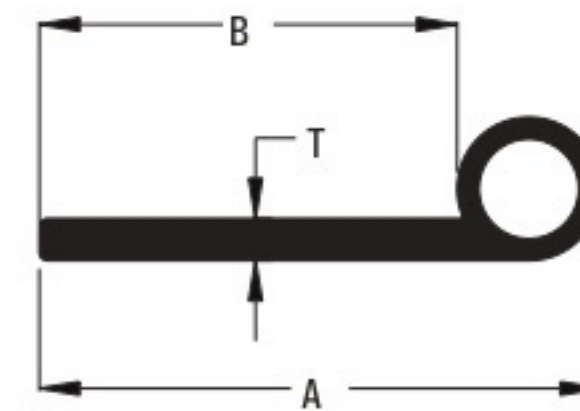

Sr. No	Section No.	A (mm)	B (mm)	T (mm)	Weight(Kg./Mtr)	Weight(Kg./12')
1	6177	34.85	26.19	2.6	0.301	1.000-1.100

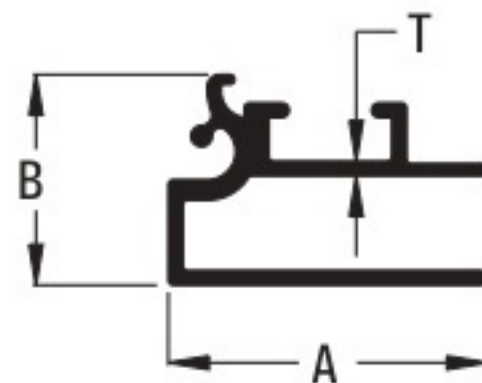

Sr. No	Section No.	A (mm)	B (mm)	T (mm)	Weight(Kg./Mtr)	Weight(Kg./12')
1	6155	19.7	13	0.9	0.159	0.580-0.700

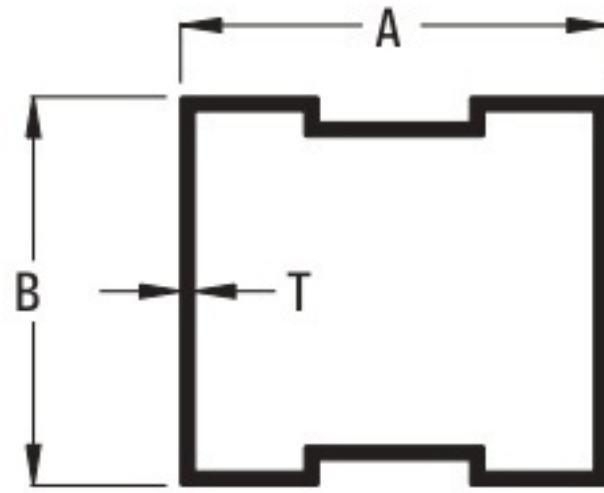

Sr. No	Section No.	A (mm)	B (mm)	T (mm)	Weight(Kg./Mtr)	Weight(Kg./12')
1	6088	55	50	1.8	1.053	3.850-4.050

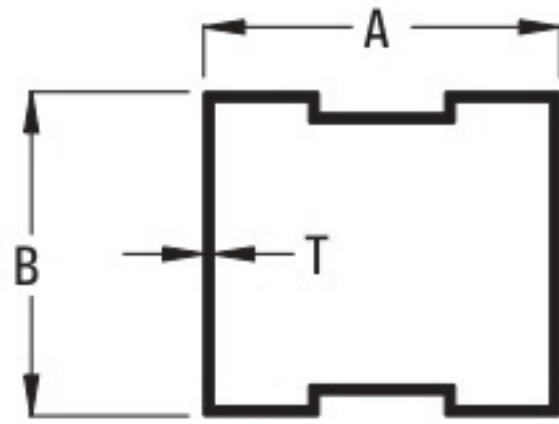

Sr. No	Section No.	A (mm)	B (mm)	T (mm)	Weight(Kg./Mtr)	Weight(Kg./12')
1	6089	55	50	1.50	0.875	3.200-3.400

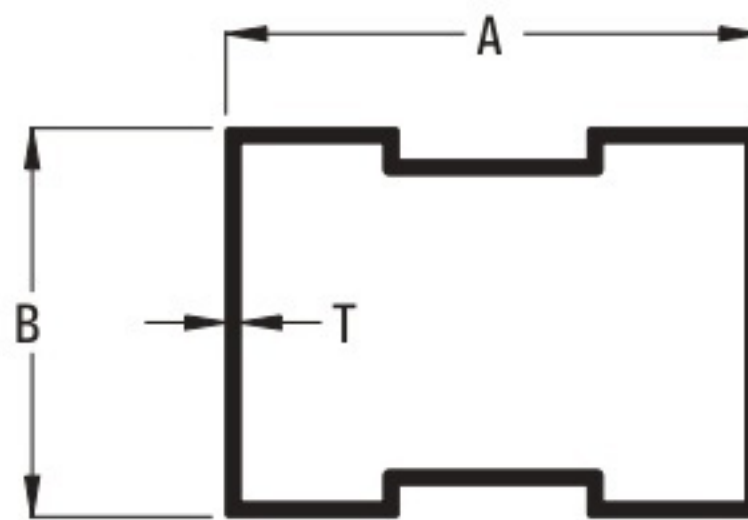

Sr. No	Section No.	A (mm)	B (mm)	T (mm)	Weight(Kg./Mtr)	Weight(Kg./12')
1	6090	55	40	1.50	0.793	2.900-3.100

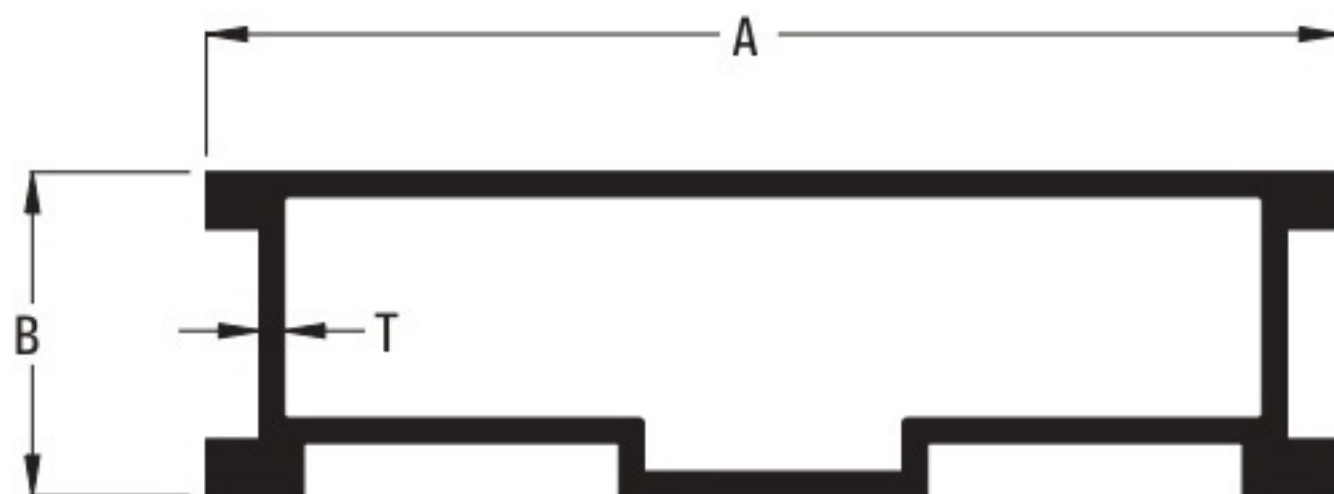

Sr. No	Section No.	A (mm)	B (mm)	T (mm)	Weight(Kg./Mtr)	Weight(Kg./12')
1	6091	70.0	20.0	1.50	0.820	3.000-3.200

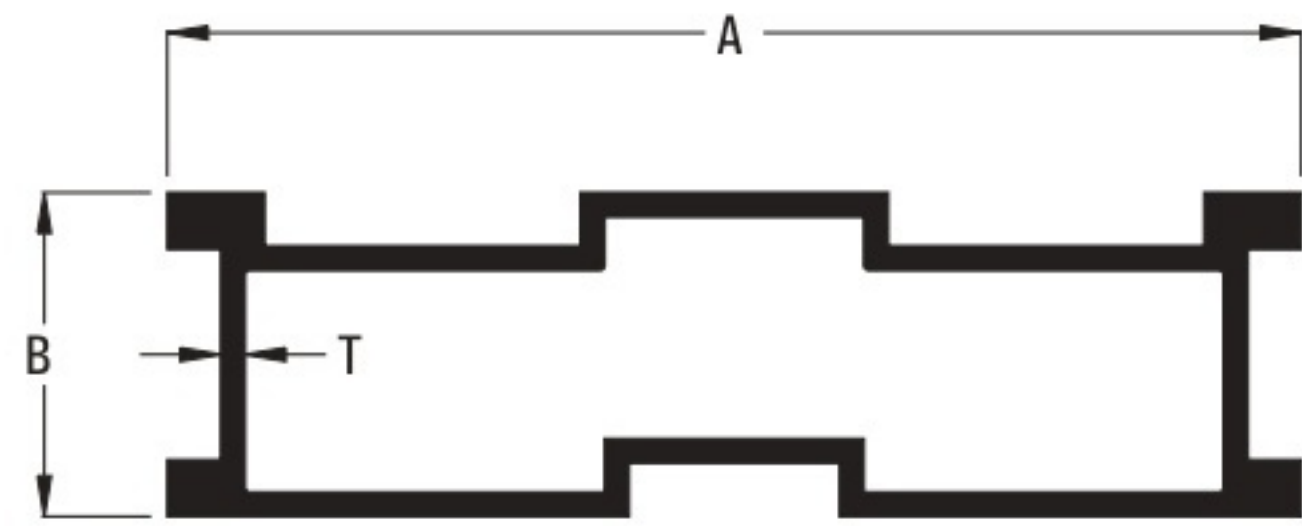

Sr. No	Section No.	A (mm)	B (mm)	T (mm)	Weight(Kg./Mtr)	Weight(Kg./12')
1	6099	70.0	20.0	1.5	0.848	3.100-3.300



Sr. No	Section No.	A (mm)	B (mm)	T (mm)	Weight(Kg./Mtr)	Weight(Kg./12')
1	6161	150.0	25.0	1.5	1.079	3.950-4.200



Sr. No	Section No.	A (mm)	B (mm)	T (mm)	Weight(Kg./Mtr)	Weight(Kg./12')
1	6162	75.0	25.0	1.5	0.574	2.100-2.300

Solar Panel SECTION

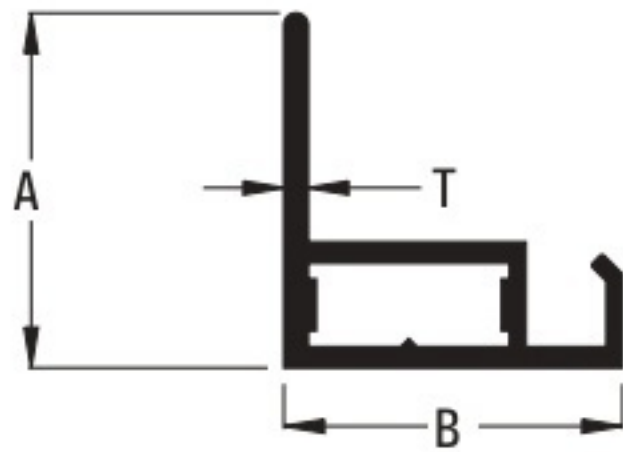

Sr. No	Section No.	A (mm)	B (mm)	T (mm)	Weight(Kg./Mtr)	Weight(Kg./12')
1	6158	22	21	1.5	0.244	0.891-1.091

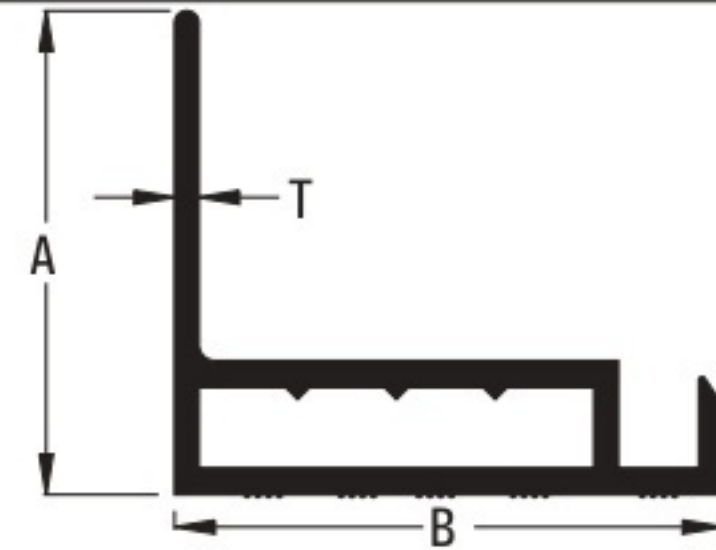

Sr. No	Section No.	A (mm)	B (mm)	T (mm)	Weight(Kg./Mtr)	Weight(Kg./12')
1	6093	30	34	1.5	0.426	1.5597-1.7597

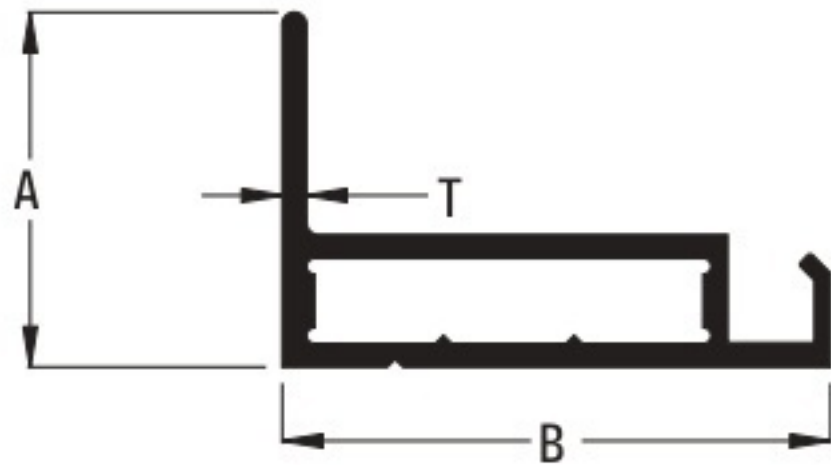

Sr. No	Section No.	A (mm)	B (mm)	T (mm)	Weight(Kg./Mtr)	Weight(Kg./12')
1	6156	22	34	1.5	0.369	1.350-1.550

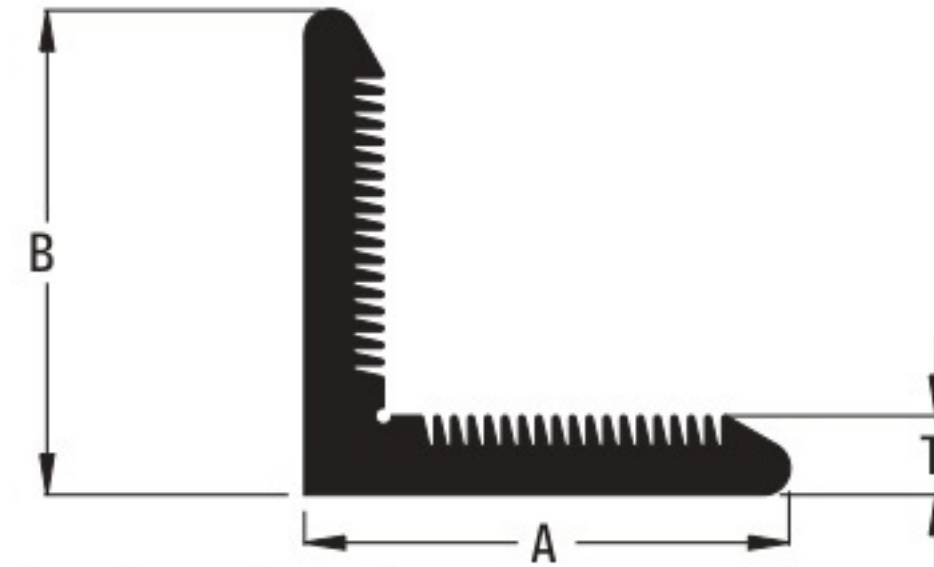

Sr. No	Section No.	A (mm)	B (mm)	T (mm)	Weight(Kg./Mtr)	Weight(Kg./12')
1	6159	30	30	5	1.230	4.500-4.700

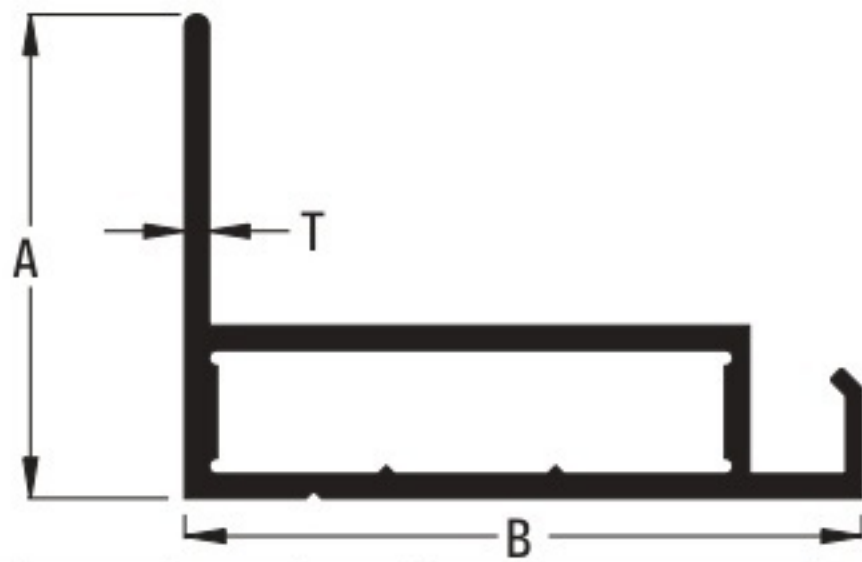

Sr. No	Section No.	A (mm)	B (mm)	T (mm)	Weight(Kg./Mtr)	Weight(Kg./12')
1	6157	30	42	1.5	0.478	1.750-1.950

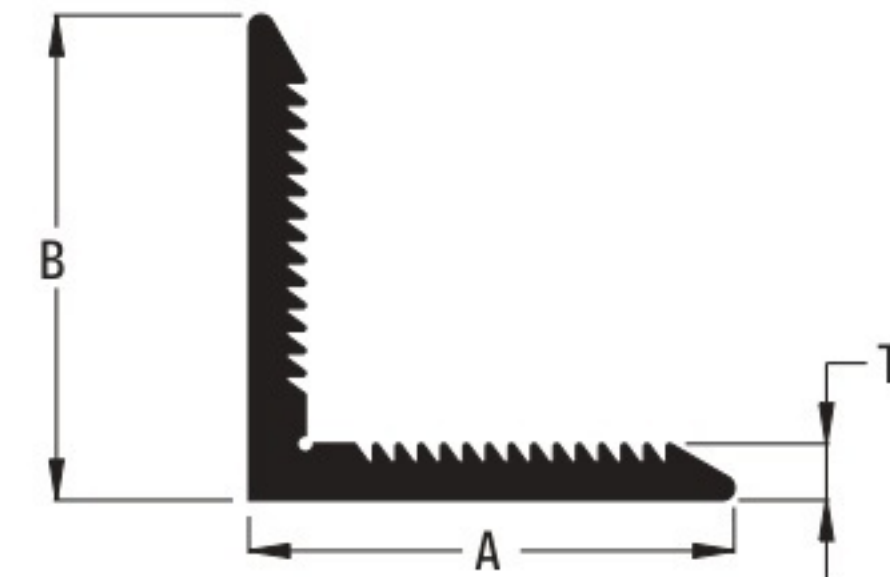

Sr. No	Section No.	A (mm)	B (mm)	T (mm)	Weight(Kg./Mtr)	Weight(Kg./12')
1	6160	30.1	30.1	5	0.913	3.340-3.640

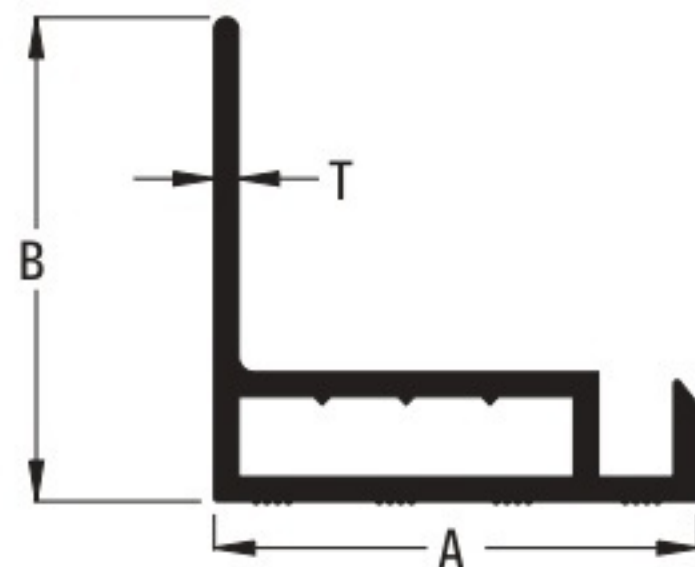

Sr. No	Section No.	A (mm)	B (mm)	T (mm)	Weight(Kg./Mtr)	Weight(Kg./12')
1	6094	30	30	1.5	0.372	1.360-1.560

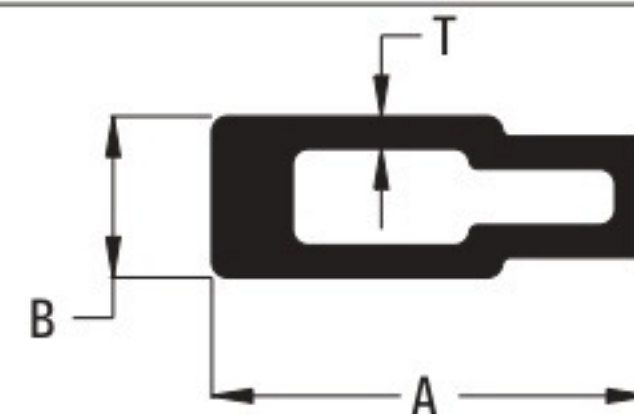

Sr. No	Section No.	A (mm)	B (mm)	T (mm)	Weight(Kg./Mtr)	Weight(Kg./12')
1	4519	27.0	10.0	2.0	0.406	1.486-1.686

LIFT SECTION

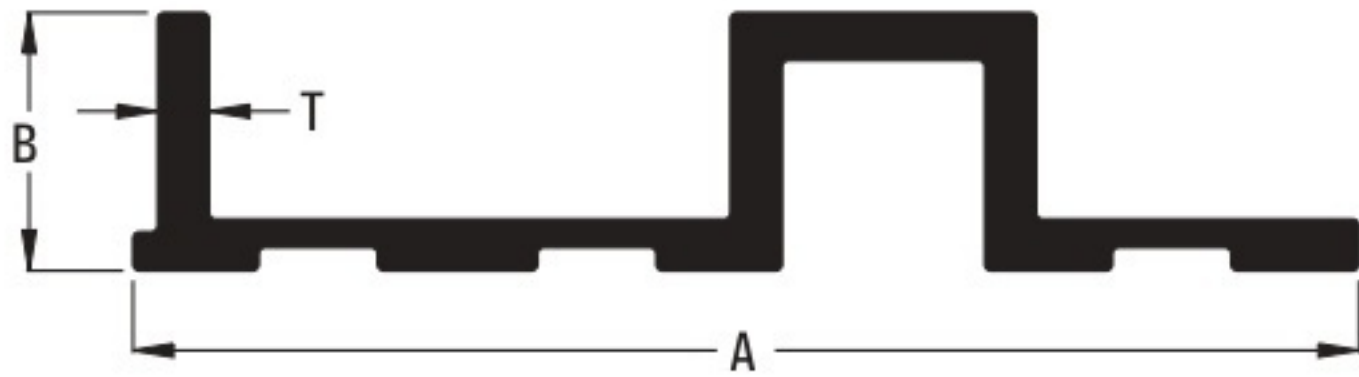

Sr. No	Section No.	A (mm)	B (mm)	T (mm)	Weight(Kg./Mtr)	Weight(Kg./12')
1	2116	95	20	4.0	1.394	5.100-5.500

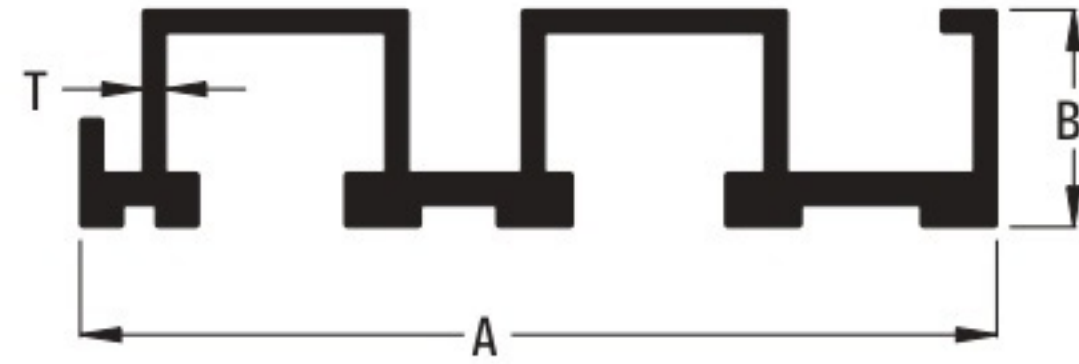

Sr. No	Section No.	A (mm)	B (mm)	T (mm)	Weight(Kg./Mtr)	Weight(Kg./12')
1	2488	84.40	20.00	2.10	1.340	4.900-5.100



Sr. No	Section No.	A (mm)	B (mm)	T (mm)	Weight(Kg./Mtr)	Weight(Kg./12')
1	2117	54.0	30.0	1.50	0.984	3.600-4.000



Sr. No	Section No.	A (mm)	B (mm)	T (mm)	Weight(Kg./Mtr)	Weight(Kg./12')
1	2489	121.0	17.00	3.00	1.651	6.050-6.250

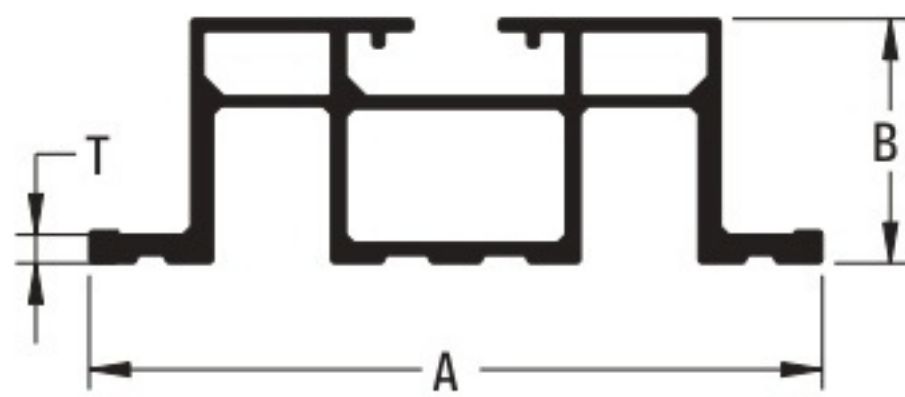

Sr. No	Section No.	A (mm)	B (mm)	T (mm)	Weight(Kg./Mtr)	Weight(Kg./12')
1	2118	90.90	30.30	3.50	1.504	5.500-6.000

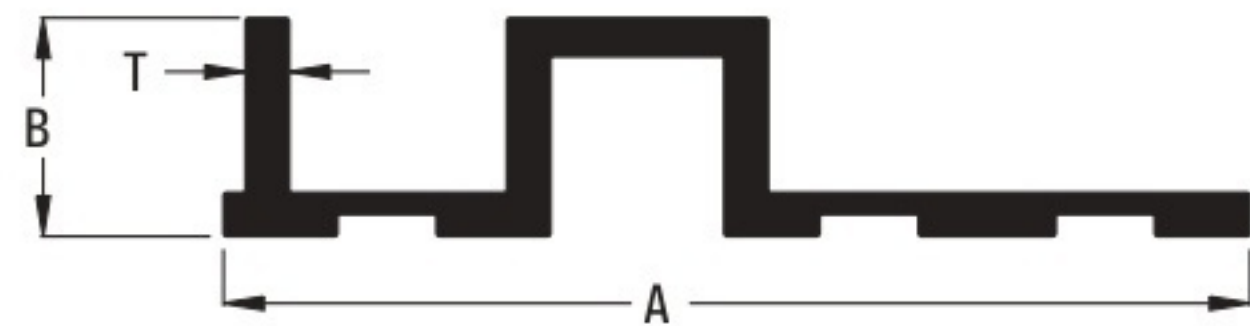

Sr. No	Section No.	A (mm)	B (mm)	T (mm)	Weight(Kg./Mtr)	Weight(Kg./12')
1	2490	93.5	19.9	4.00	1.340	4.900-5.100

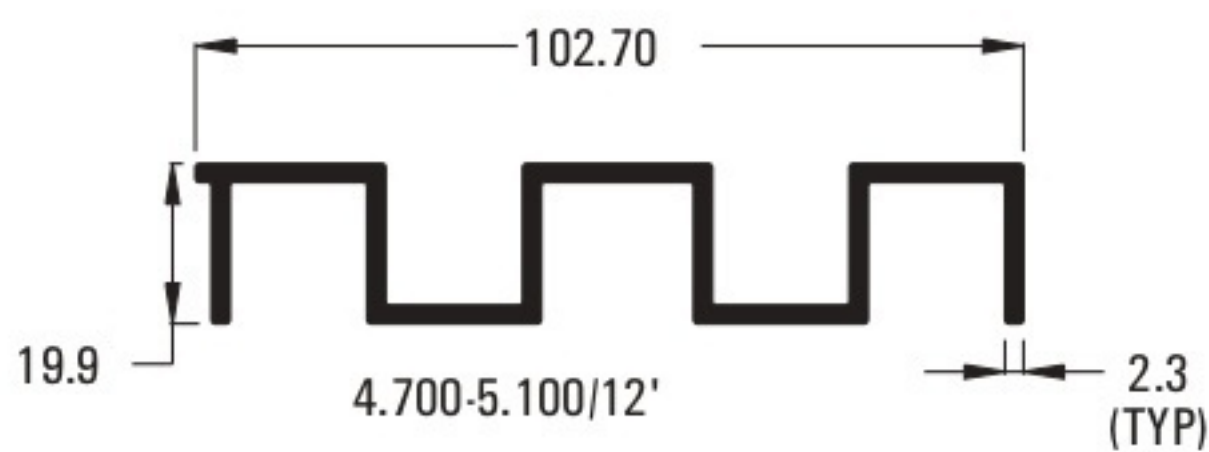

Sr. No	Section No.	A (mm)	B (mm)	T (mm)	Weight(Kg./Mtr)	Weight(Kg./12')
1	2465	102.70	19.90	2.30	1.285	4.700-5.100



Sr. No	Section No.	A (mm)	B (mm)	T (mm)	Weight(Kg./Mtr)	Weight(Kg./12')
1	5039	115.0	20.0	4.0	2.215	8.100-8.400

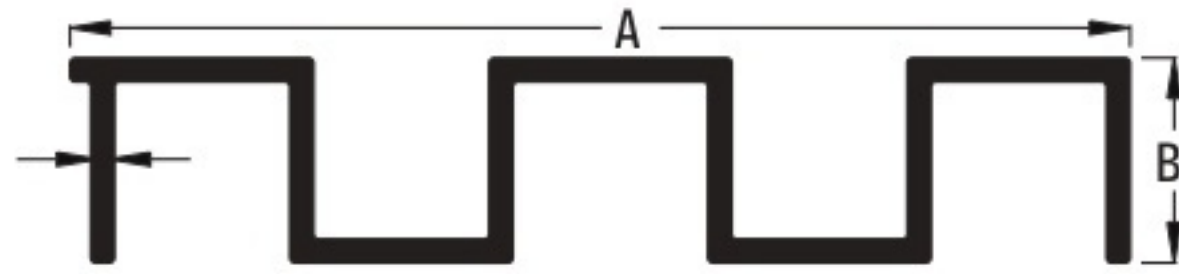

Sr. No	Section No.	A (mm)	B (mm)	T (mm)	Weight(Kg./Mtr)	Weight(Kg./12')
1	2465	102.70	19.85	2.30	1.285	4.700-5.100

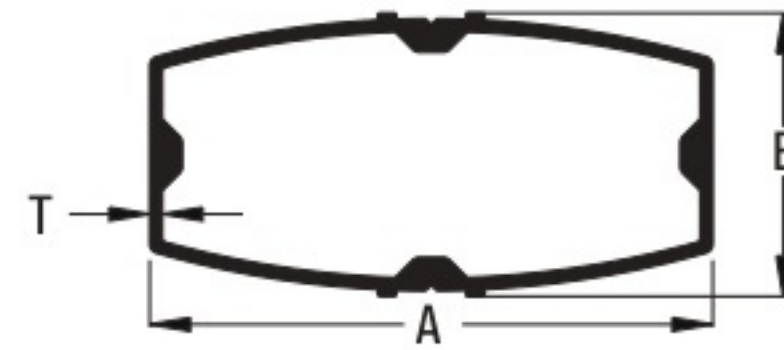

Sr. No	Section No.	A (mm)	B (mm)	T (mm)	Weight(Kg./Mtr)	Weight(Kg./12')
1	3945	60.60	30.50	1.35	0.710	2.600-3.00
2	3946	75.00	36.10	1.70	0.984	3.600-4.00

EXHIBITION

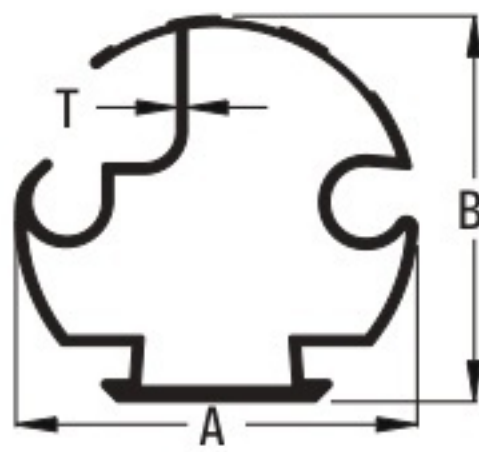

Sr. No	Section No.	A (mm)	B (mm)	T (mm)	Weight(Kg./Mtr)	Weight(Kg./12')
1	3949	54.05	51.90	1.35	0.888	3.250-3.650

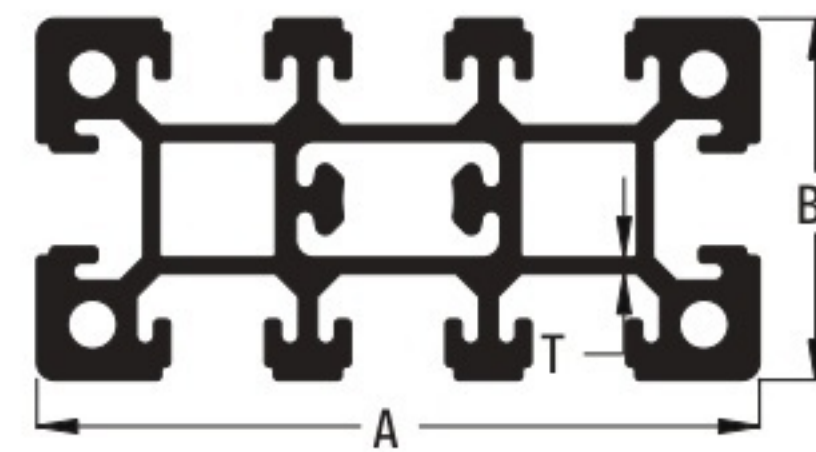

Sr. No	Section No.	A (mm)	B (mm)	T (mm)	Weight(Kg./Mtr)	Weight(Kg./Mtr.)
1	2454	80.00	40.00	1.8	0.875	3.20-3.40

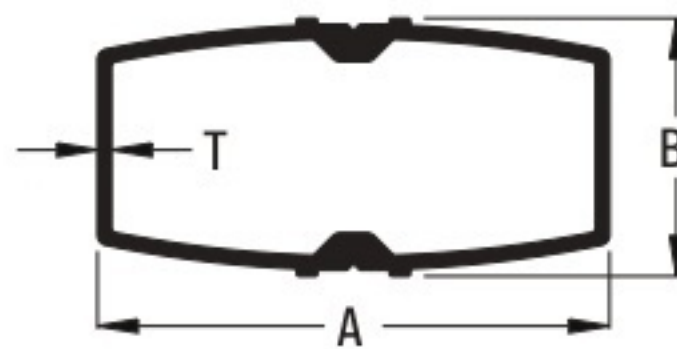

Sr. No	Section No.	A (mm)	B (mm)	T (mm)	Weight(Kg./Mtr)	Weight(Kg./12')
1	3944	49.60	25.00	1.35	0.547	2.000-2.350

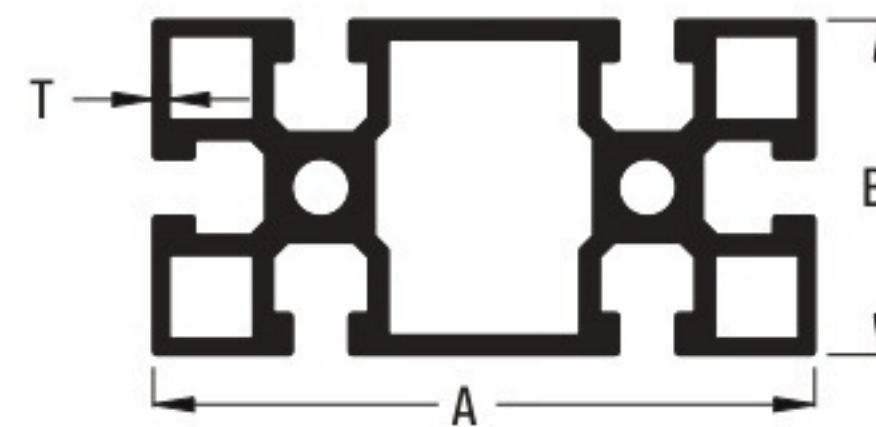

Sr. No	Section No.	A (mm)	B (mm)	T (mm)	Weight(Kg./Mtr)	Weight(Kg./12')
1	2483	89.50	45.3	2.10	3.650	13.350-13.550

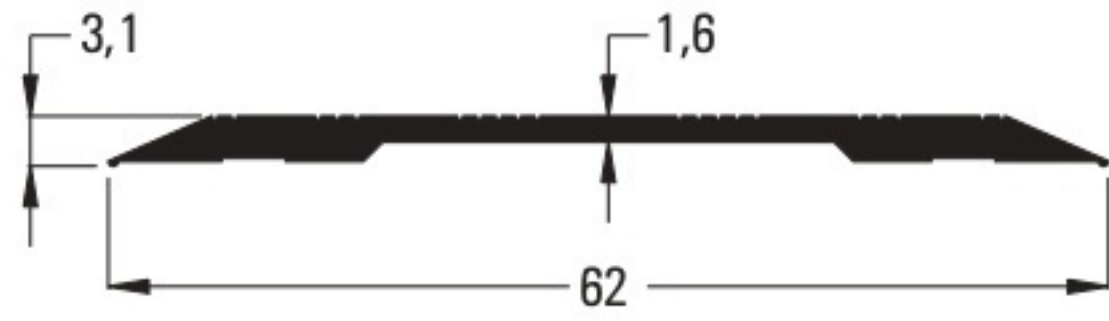

Sr. No	Section No.	A (mm)	B (mm)	T (mm)	Weight(Kg./Mtr)	Weight(Kg./12')
1	2494	158.0	7.8	4.0	1.995	7.300-7.500

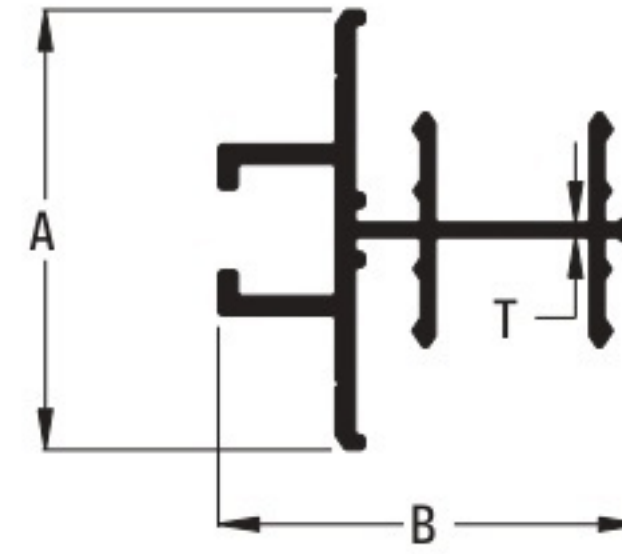

Sr. No	Section No.	A (mm)	B (mm)	T (mm)	Weight(Kg./Mtr)	Weight(Kg./12')
1	2469	45.0	43.1	1.5	0.749	2.740-2.940

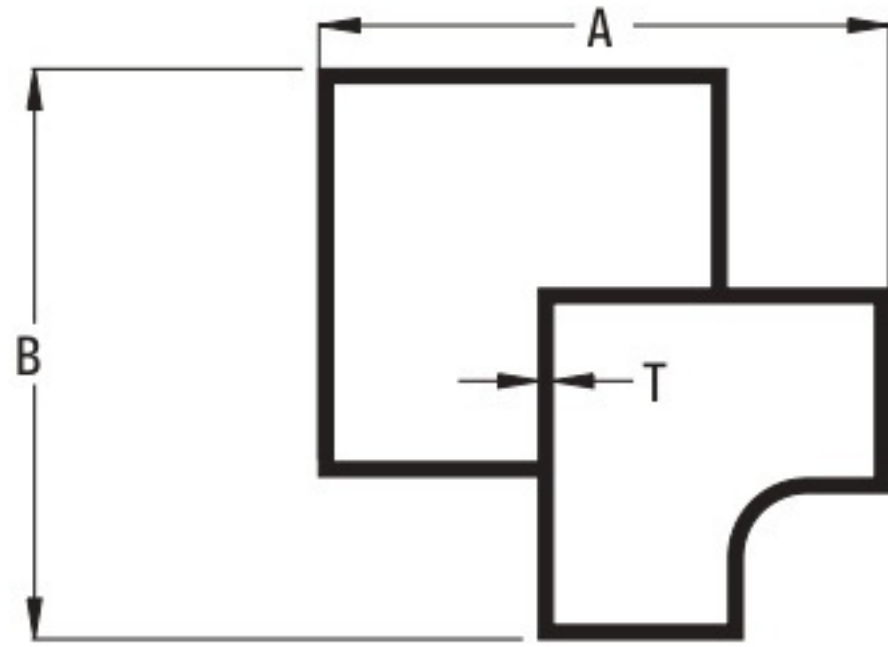

Sr. No	Section No.	A (mm)	B (mm)	T (mm)	Weight(Kg./Mtr)	Weight(Kg./12')
1	2420	70.70	70.70	1.65	1.394	5.100-5.500

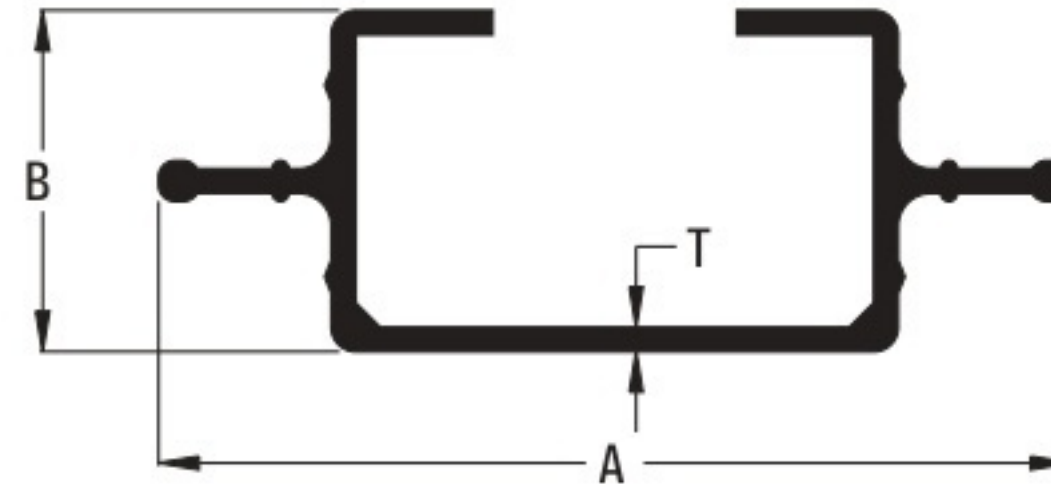

Sr. No	Section No.	A (mm)	B (mm)	T (mm)	Weight(Kg./Mtr)	Weight(Kg./12')
1	2573	56.0	21.0	1.5	0.492	1.800-2.000

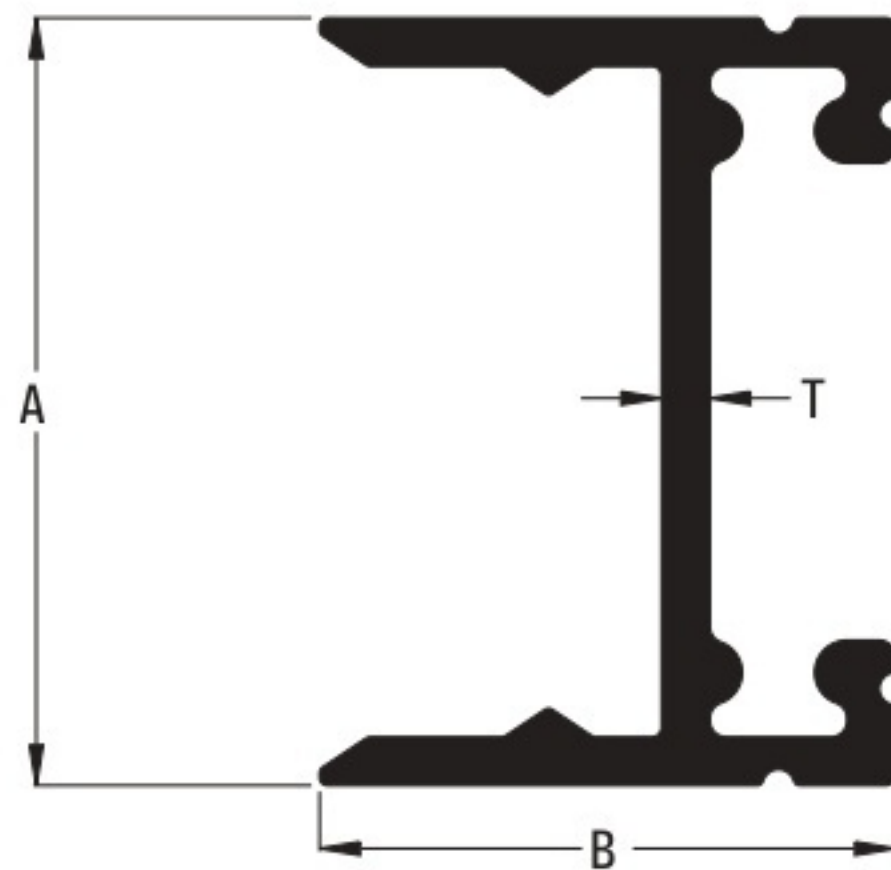

Sr. No	Section No.	A (mm)	B (mm)	T (mm)	Weight(Kg./Mtr)	Weight(Kg./12')
1	2468	24.0	18.0	1.50	0.270	0.990-1.090

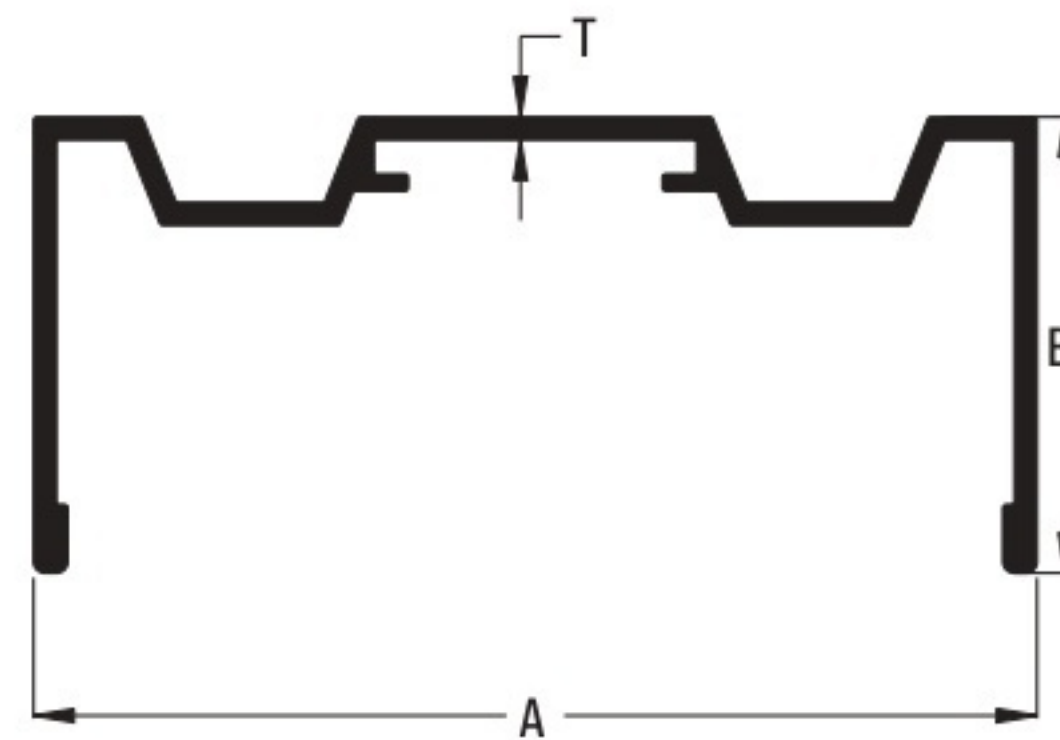

Sr. No	Section No.	A (mm)	B (mm)	T (mm)	Weight(Kg./Mtr)	Weight(Kg./12')
1	2476	24.0	18.0	1.50	1.070	3.900-4.100

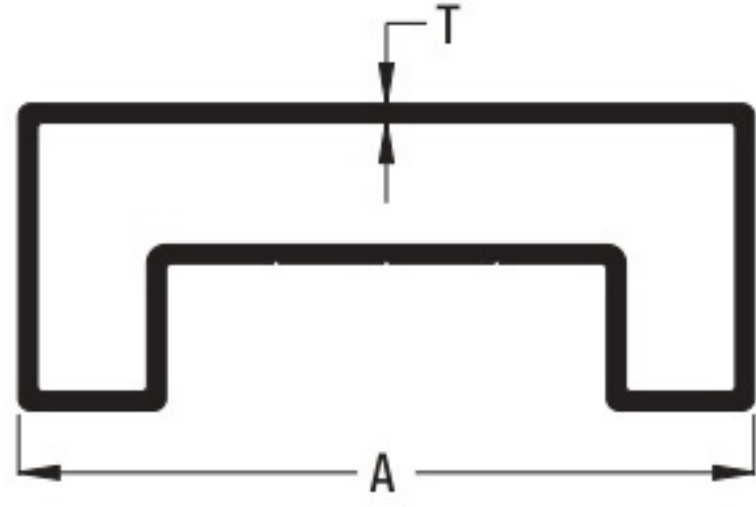

Sr. No	Section No.	A (mm)	B (mm)	T (mm)	Weight(Kg./Mtr)	Weight(Kg./12')
1	2478	60.60	25.25	1.5	0.755	2.760-2.960

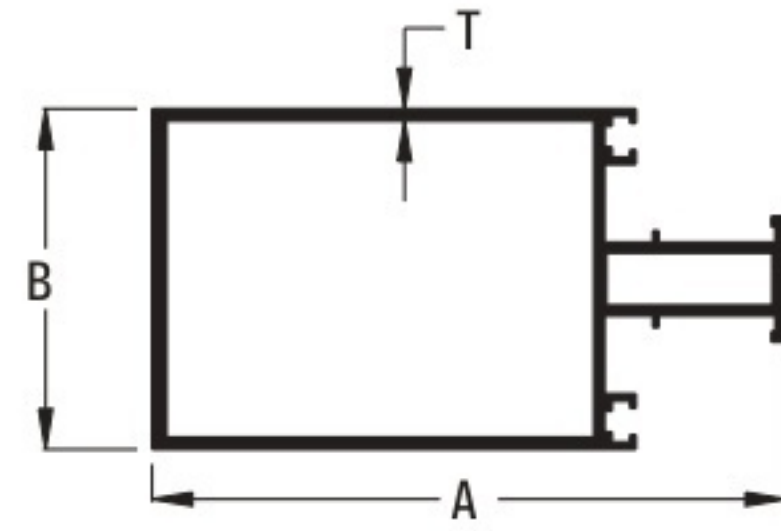

Sr. No	Section No.	A (mm)	B (mm)	T (mm)	Weight(Kg./Mtr)	Weight(Kg./12')
1	2514	100.0	70.4	2.5	2.966	10.850-11.250

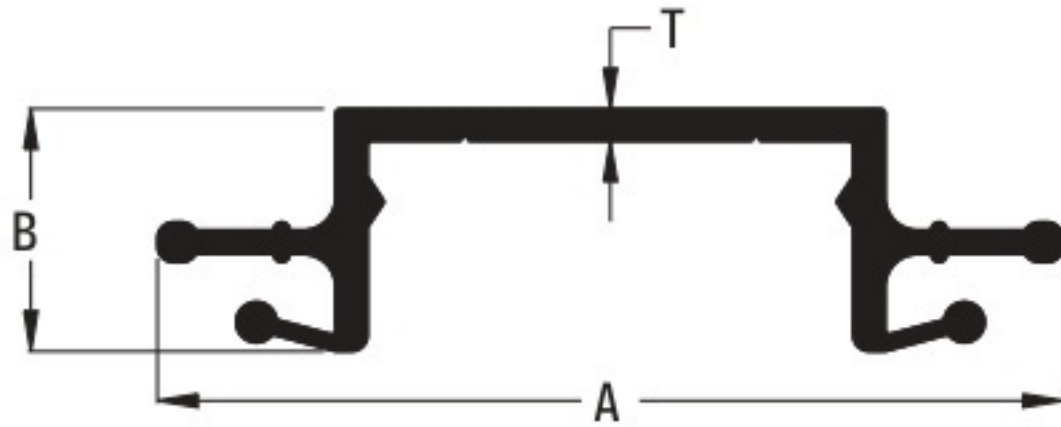

Sr. No	Section No.	A (mm)	B (mm)	T (mm)	Weight(Kg./Mtr)	Weight(Kg./12')
1	2479	56.56	15.15	2.0	0.492	1.800-2.000

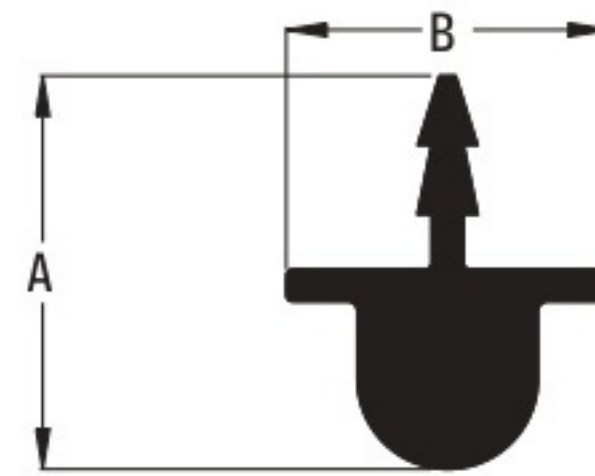

Sr. No	Section No.	A (mm)	B (mm)	T (mm)	Weight(Kg./Mtr)	Weight(Kg./12')
1	2517	12.20	10.0	...	0.116	0.425-0.525



Sr. No	Section No.	A (mm)	B (mm)	T (mm)	Weight(Kg./Mtr)	Weight(Kg./12')
1	2481	56.66	13.10	1.63	0.328	1.200-1.400



Sr. No	Section No.	A (mm)	B (mm)	Ø (mm)	Weight(Kg./Mtr)	Weight(Kg./12')
1	1721	29.7	16.5	10.25	0.191	0.600-0.700

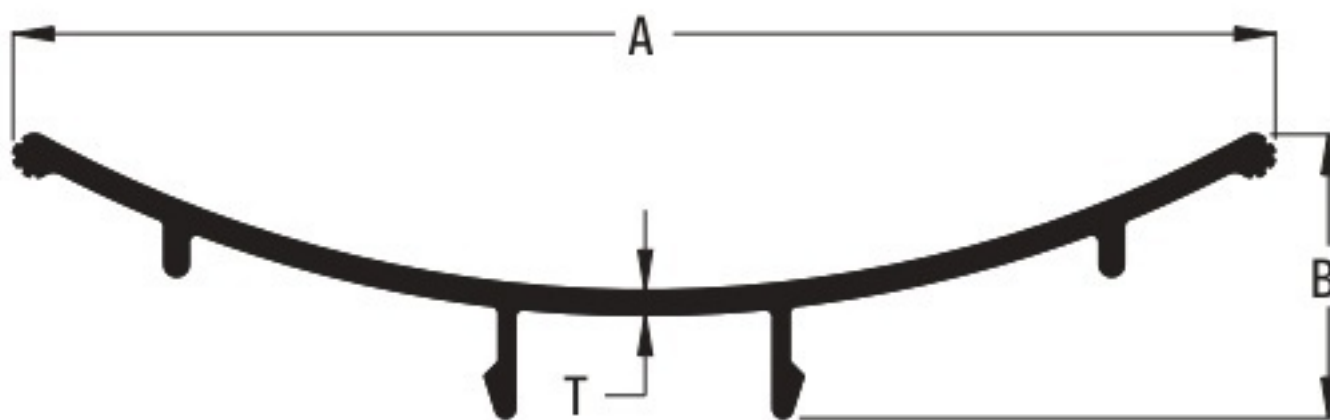

Sr. No	Section No.	A (mm)	B (mm)	T (mm)	Weight(Kg./Mtr)	Weight(Kg./12')
1	2495	78.2	17.6	1.5	0.410	1.500-1.800

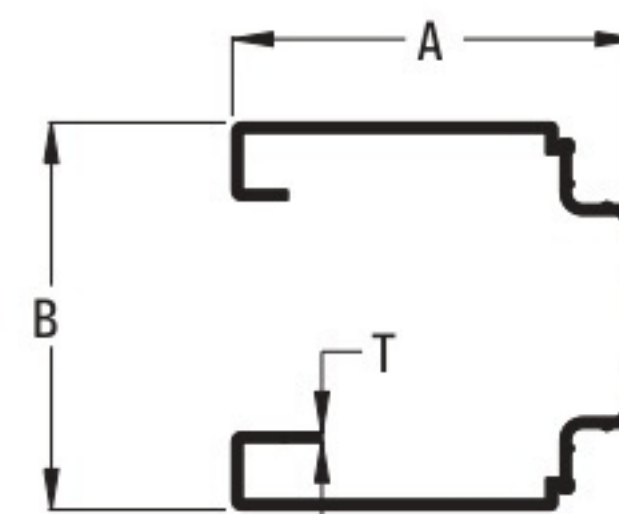

Sr. No	Section No.	A (mm)	B (mm)	T (mm)	Weight(Kg./Mtr)	Weight(Kg./12')
1	2531	62.65	60.0	1.5	0.888	3.250-3.550

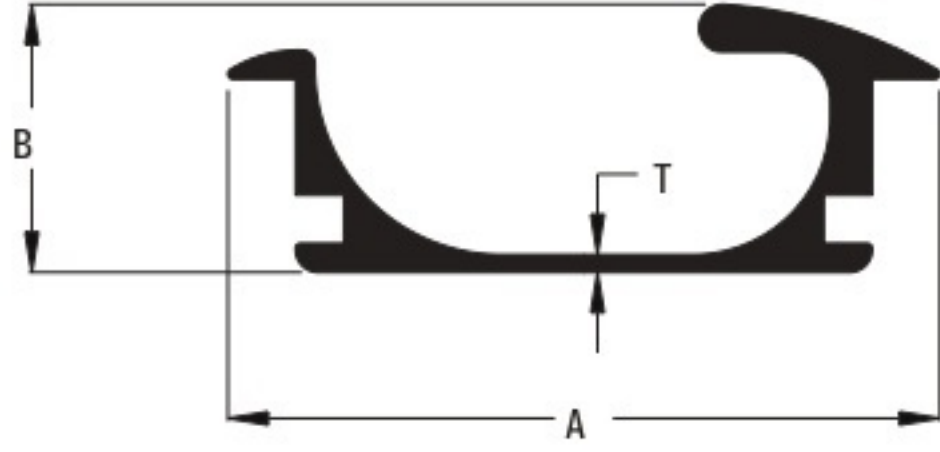

Sr. No	Section No.	A (mm)	B (mm)	T (mm)	Weight(Kg./Mtr)	Weight(Kg./12')
1	6075	44.2	16.65	1.10	0.410	1.500-1.700

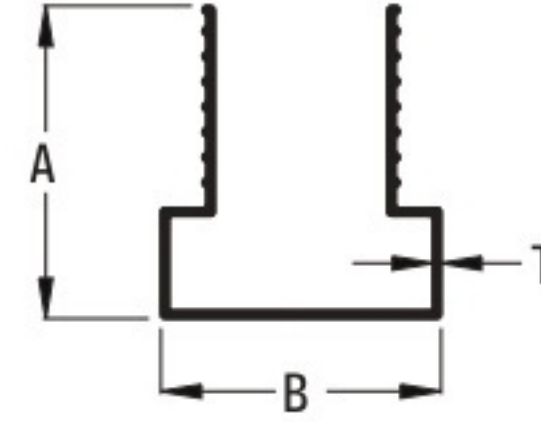

Sr. No	Section No.	A (mm)	B (mm)	T (mm)	Weight(Kg./Mtr)	Weight(Kg./12')
1	3780	19.4	17.4	0.5	0.101	0.370-0.470



Sr. No	Section No.	A (mm)	B (mm)	T (mm)	Weight(Kg./Mtr)	Weight(Kg./12')
1	2559	22.10	10.80	2.20	0.265	0.970-1.170

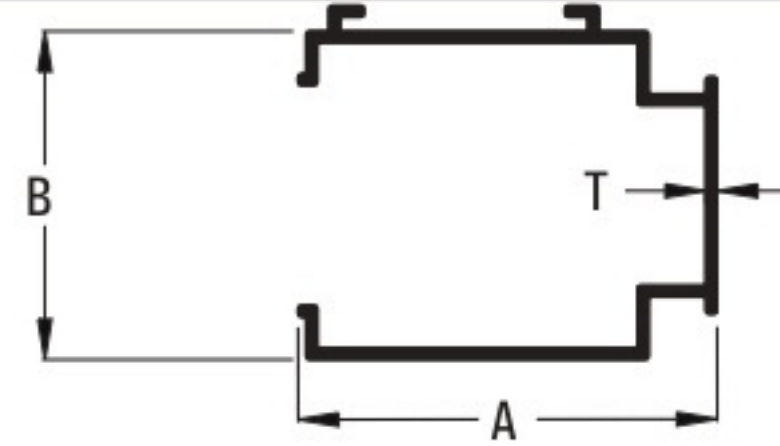

Sr. No	Section No.	A (mm)	B (mm)	T (mm)	Weight(Kg./Mtr)	Weight(Kg./12')
1	3782	37.10	31.36	1.0	0.314	1.150-1.350

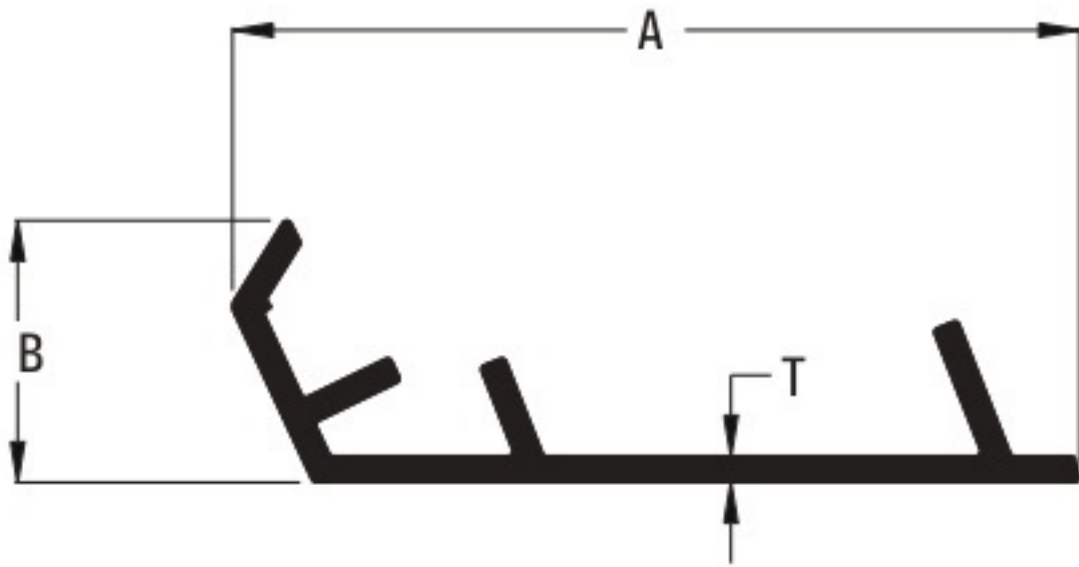

Sr. No	Section No.	A (mm)	B (mm)	T (mm)	Weight(Kg./Mtr)	Weight(Kg./12')
1	2562	52.50	16.25	1.65	0.377	1.380-1.580

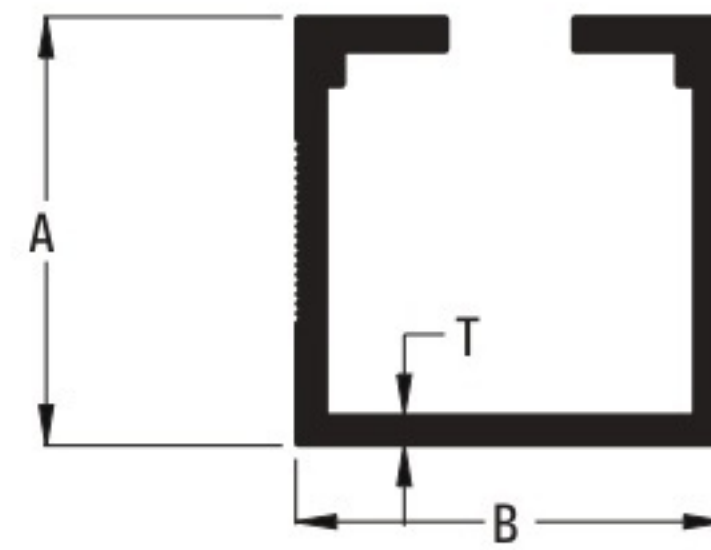

Sr. No	Section No.	A (mm)	B (mm)	T (mm)	Weight(Kg./Mtr)	Weight(Kg./12')
1	3783	44.30	44.30	3.15	1.326	4.850-5.050

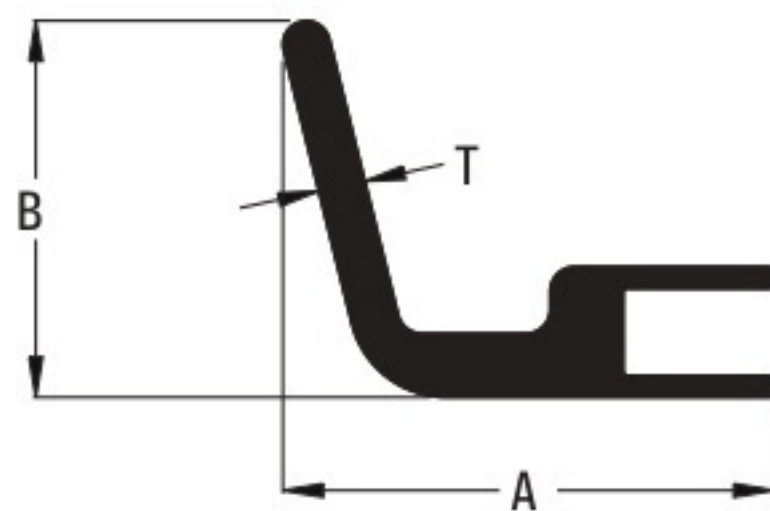

Sr. No	Section No.	A (mm)	B (mm)	T (mm)	Weight(Kg./Mtr)	Weight(Kg./12')
1	3627	60.90	46.70	5.9	1.714	6.270-6.470

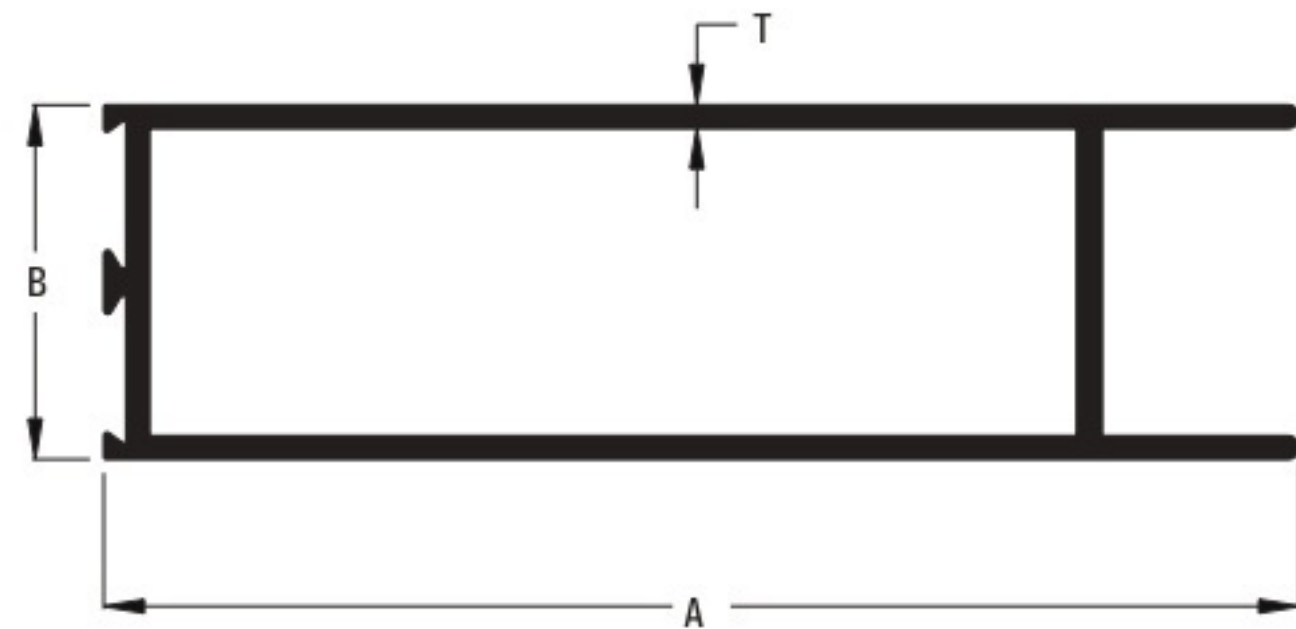

Sr. No	Section No.	A (mm)	B (mm)	T (mm)	Weight(Kg./Mtr)	Weight(Kg./12')
1	2341	150.0	44.60	2.90	3.062	11.200-11.500

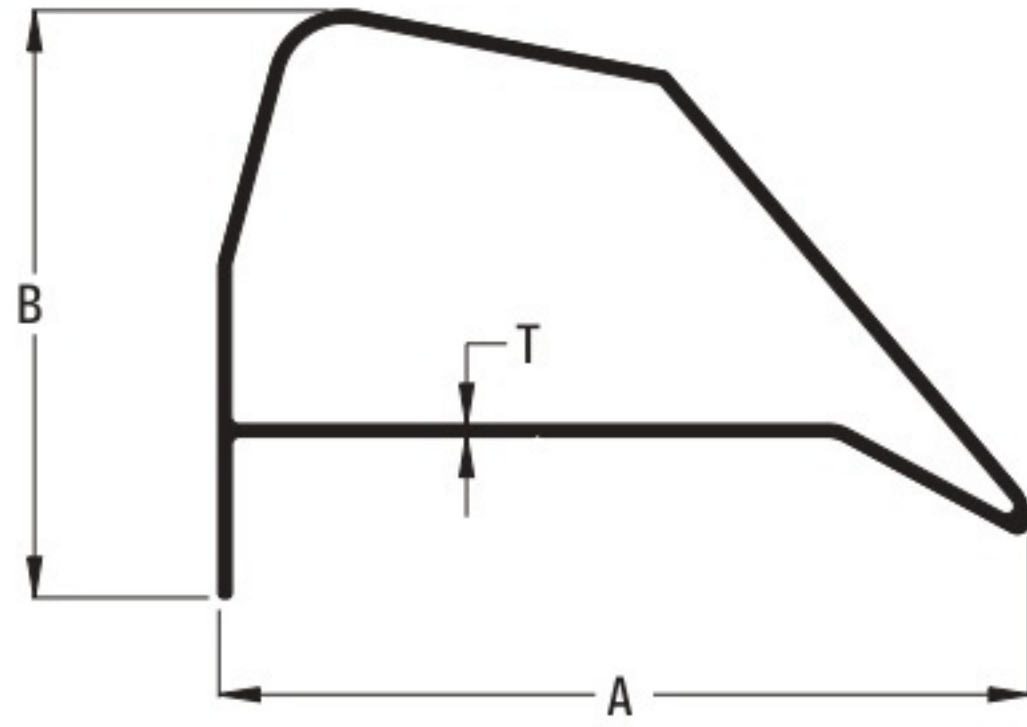

Sr. No	Section No.	A (mm)	B (mm)	T (mm)	Weight(Kg./Mtr)	Weight(Kg./12')
1	3960	100.5	72.8	1.5	1.170	4.300-4.700

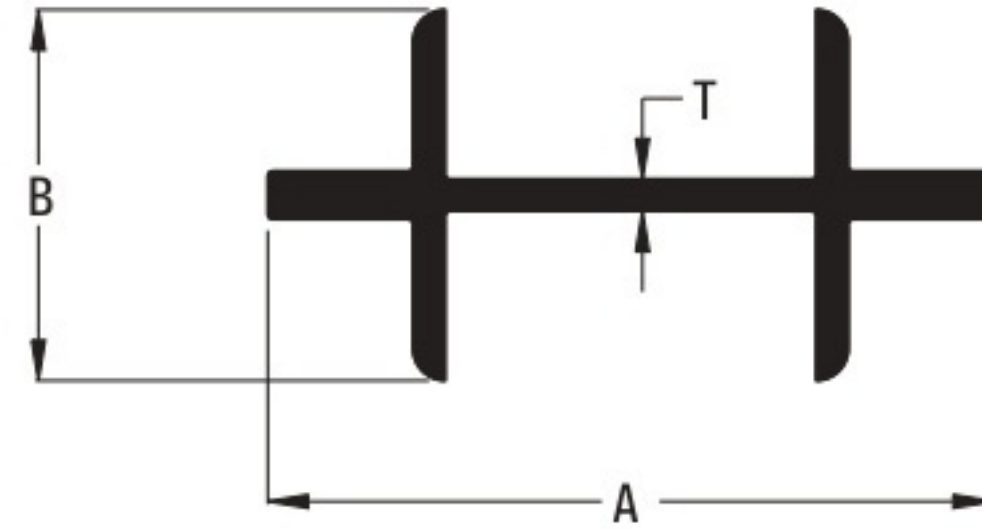

Sr. No	Section No.	A (mm)	B (mm)	T (mm)	Weight(Kg./Mtr)	Weight(Kg./12')
1	4524	45.0	23.0	2.0	0.510	1.865-2.065



Sr. No	Section No.	A (mm)	B (mm)	T (mm)	Weight(Kg./Mtr)	Weight(Kg./12')
1	3961	21.40	9.70	---	0.395	1.450-1.650

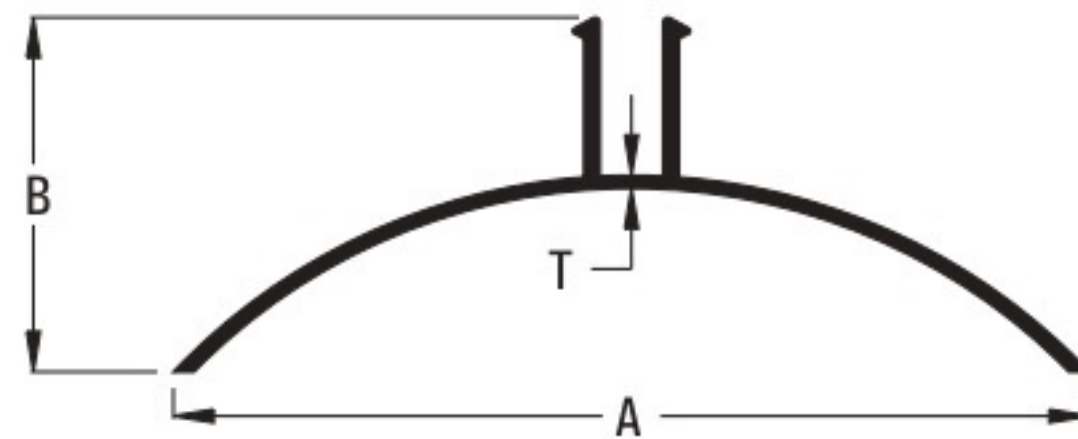

Sr. No	Section No.	A (mm)	B (mm)	T (mm)	Weight(Kg./Mtr)	Weight(Kg./12')
1	4525	56.8	22.0	0.8	0.194	0.710-0.810

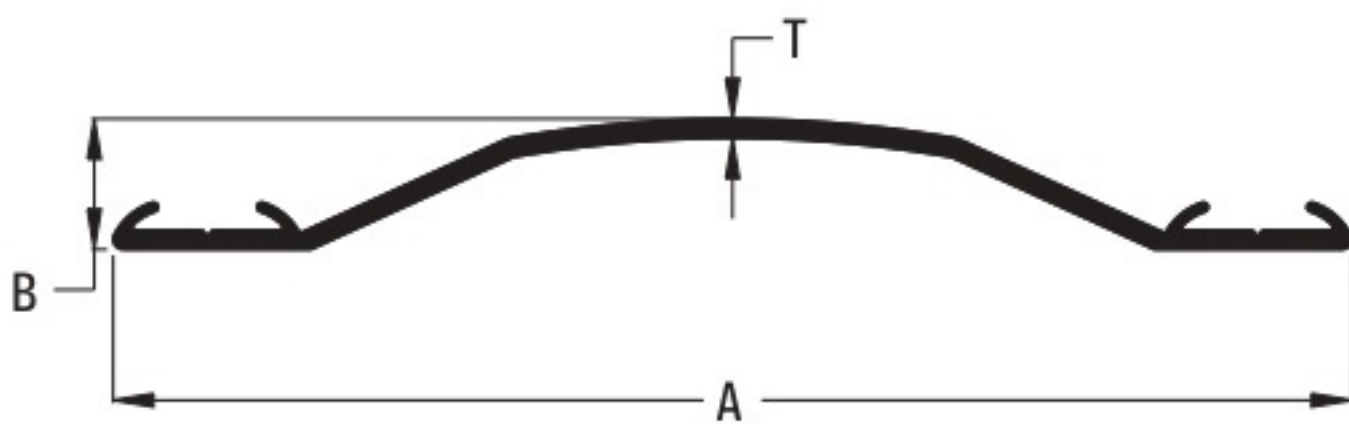

Sr. No	Section No.	A (mm)	B (mm)	T (mm)	Weight(Kg./Mtr)	Weight(Kg./12')
1	3968	128.0	13.50	2.00	0.765	2.800-3.000

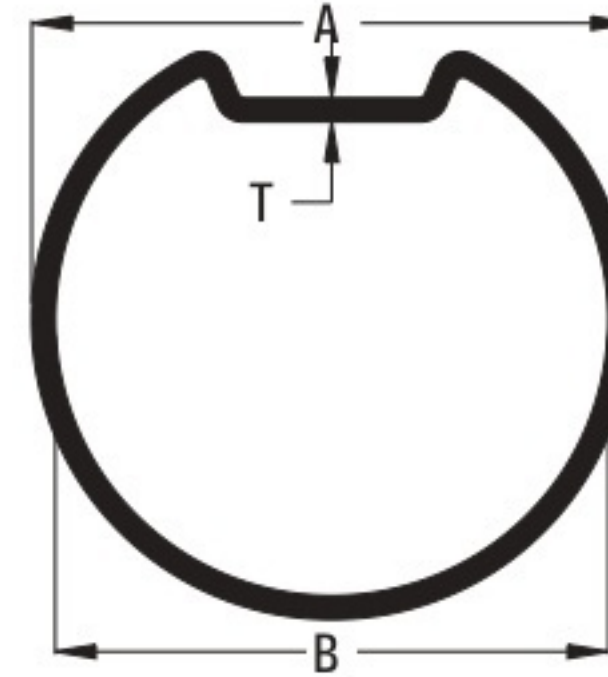

Sr. No	Section No.	A (mm)	B (mm)	T (mm)	Weight(Kg./Mtr)	Weight(Kg./12')
1	1816	46.51	43.99	1.80	0.177	0.650-0.750

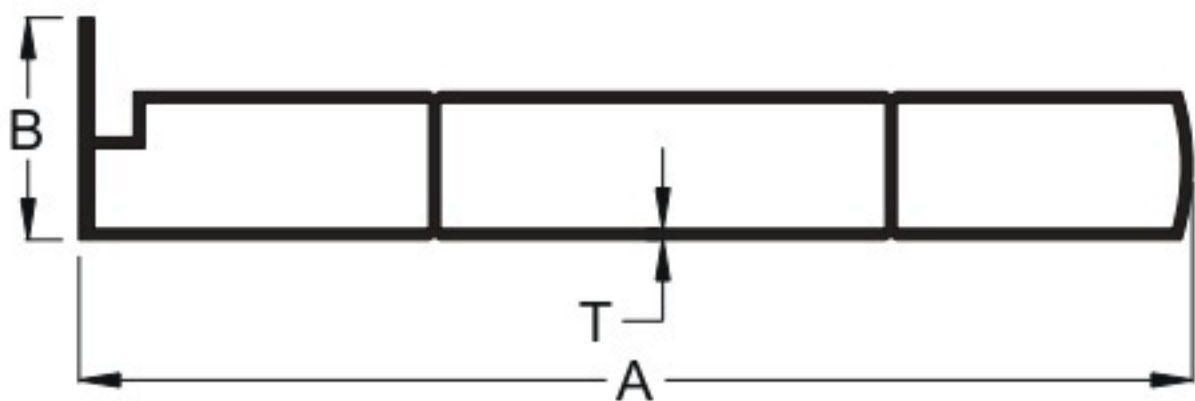

Sr. No	Section No.	A (mm)	B (mm)	T (mm)	Weight(Kg./Mtr)	Weight(Kg./12')
1	4521	96.80	19.50	0.95	0.667	2.440-2.640

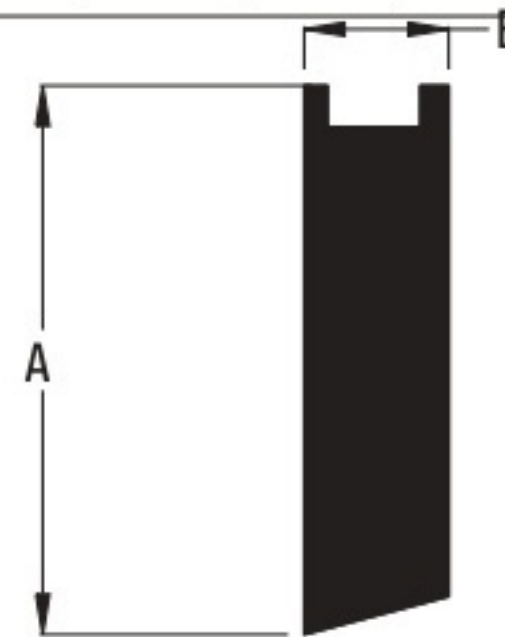

Sr. No	Section No.	A (mm)	B (mm)	T (mm)	Weight(Kg./Mtr)	Weight(Kg./12')
1	1325	53.20	14.0	---	1.845	6.750-6.950

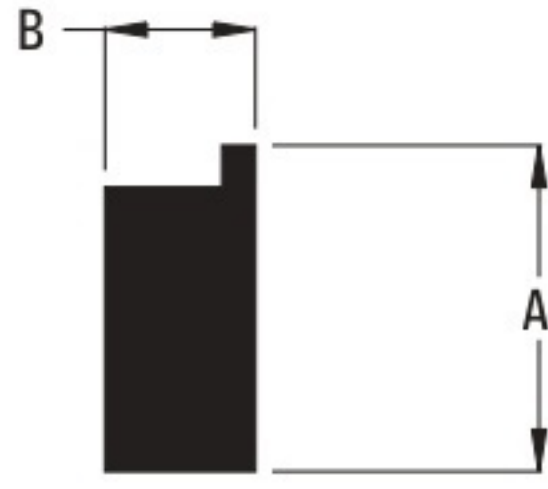

Sr. No	Section No.	A (mm)	B (mm)	T (mm)	Weight(Kg./Mtr)	Weight(Kg./12')
1	1326	19.5	9.0	...	0.426	1.560-1.760

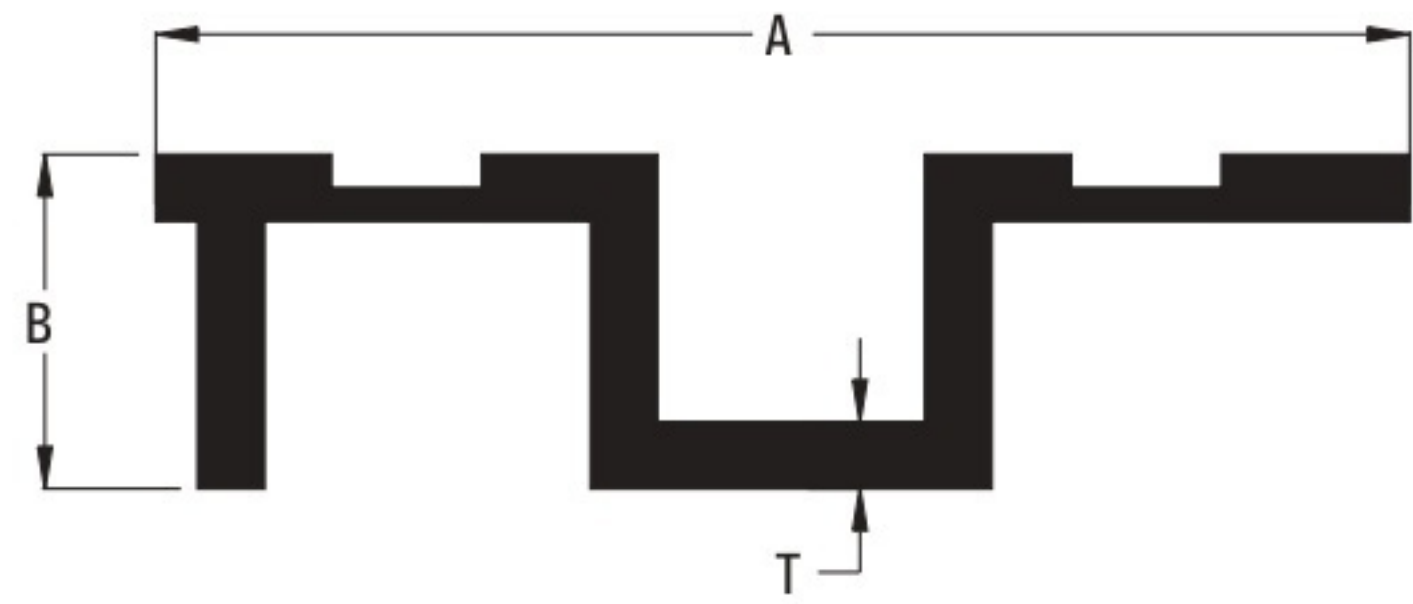

Sr. No	Section No.	A (mm)	B (mm)	T (mm)	Weight(Kg./Mtr)	Weight(Kg./12')
1	6065	75.0	20.0	4.0	1.230	4.500-4.700

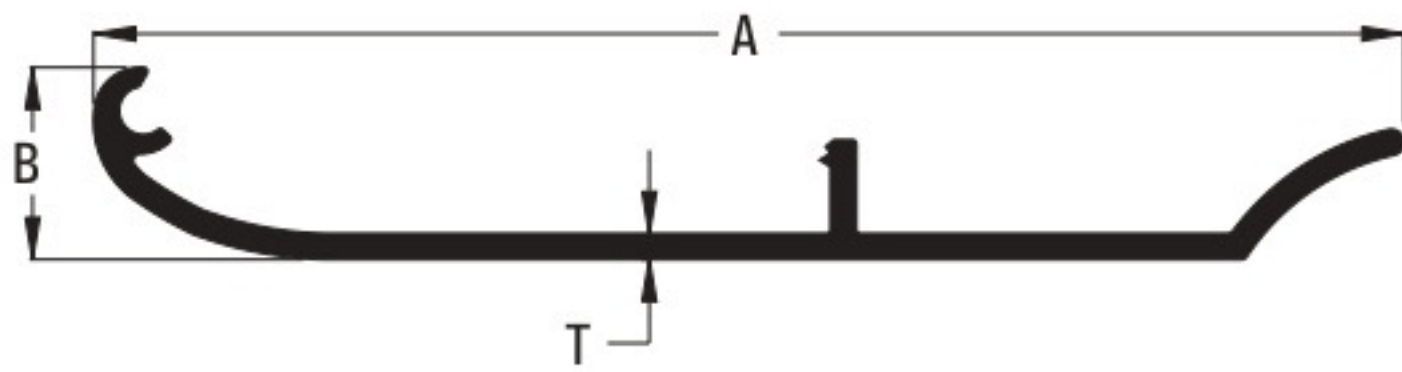

Sr. No	Section No.	A (mm)	B (mm)	T (mm)	Weight(Kg./Mtr)	Weight(Kg./12')
1	5035	98.0	14.38	2.0	0.620	2.280-2.480

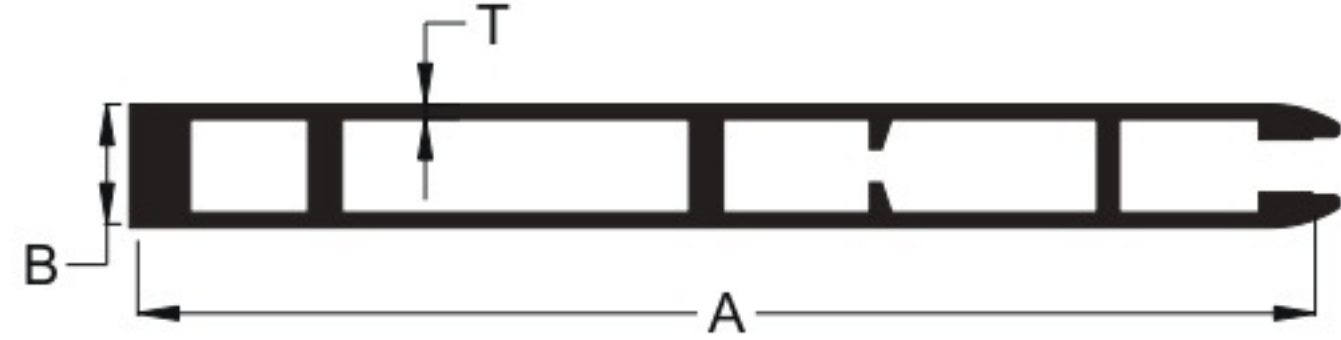

Sr. No	Section No.	A (mm)	B (mm)	T (mm)	Weight(Kg./Mtr)	Weight(Kg./12')
1	6166	90.5	9.2	1.10	0.847	3.100-3.300

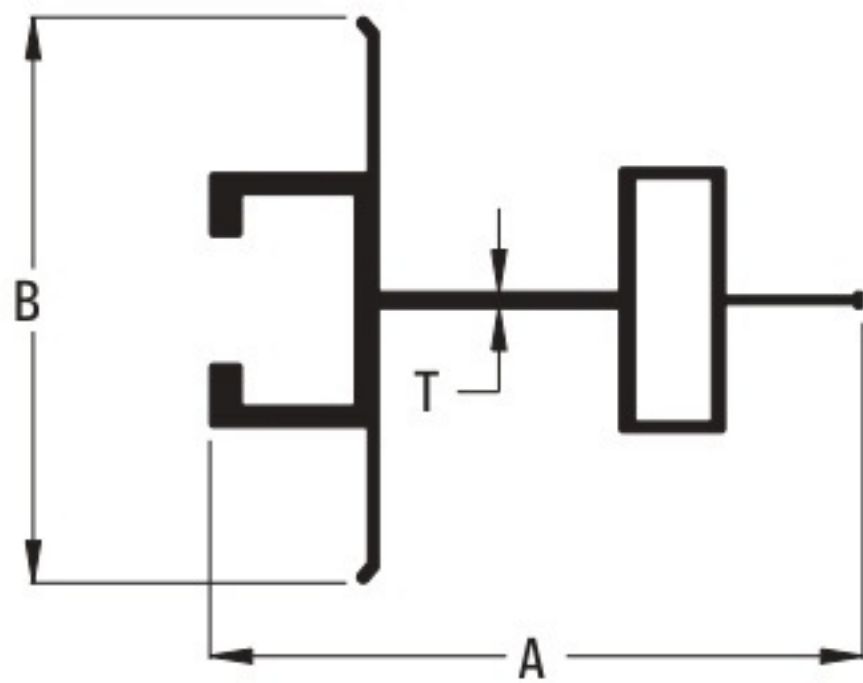

Sr. No	Section No.	A (mm)	B (mm)	T (mm)	Weight(Kg./Mtr)	Weight(Kg./12')
1	6040	55.8	48.4	1.40	0.635	2.330-2.530

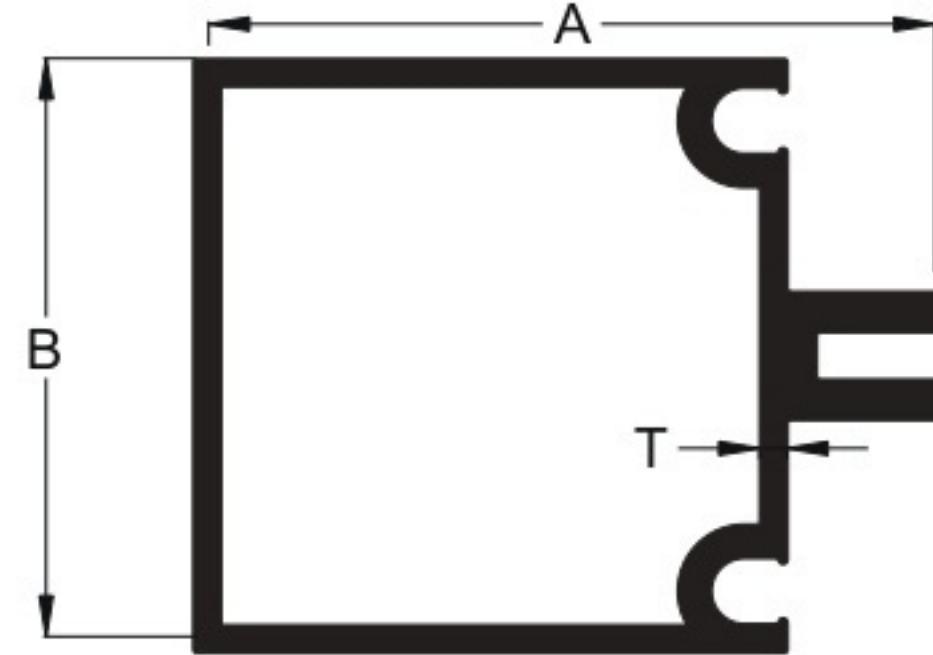

Sr. No	Section No.	A (mm)	B (mm)	T (mm)	Weight(Kg./Mtr)	Weight(Kg./12')
1	6163	63.8	50.8	2.4	1.640	6.000-6.200

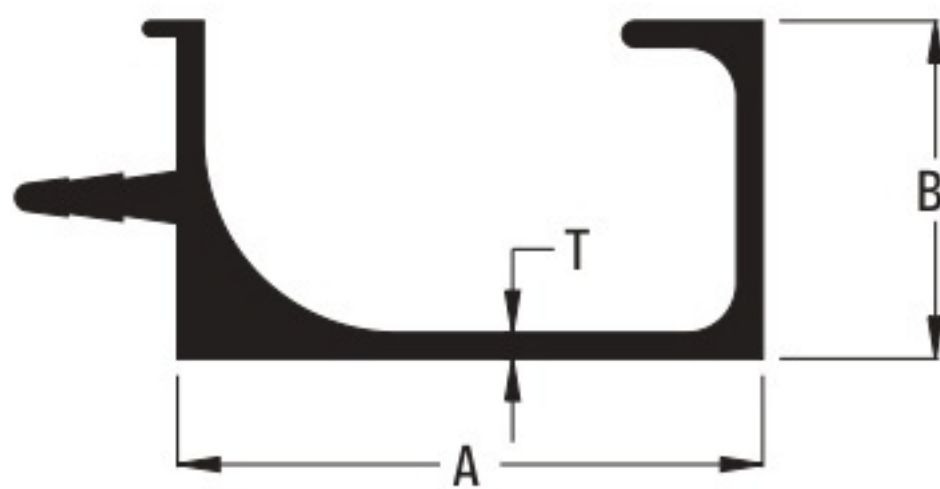

Sr. No	Section No.	A (mm)	B (mm)	T (mm)	Weight(Kg./Mtr)	Weight(Kg./12')
1	6074	35.0	20.2	1.60	0.480	1.765-1.965

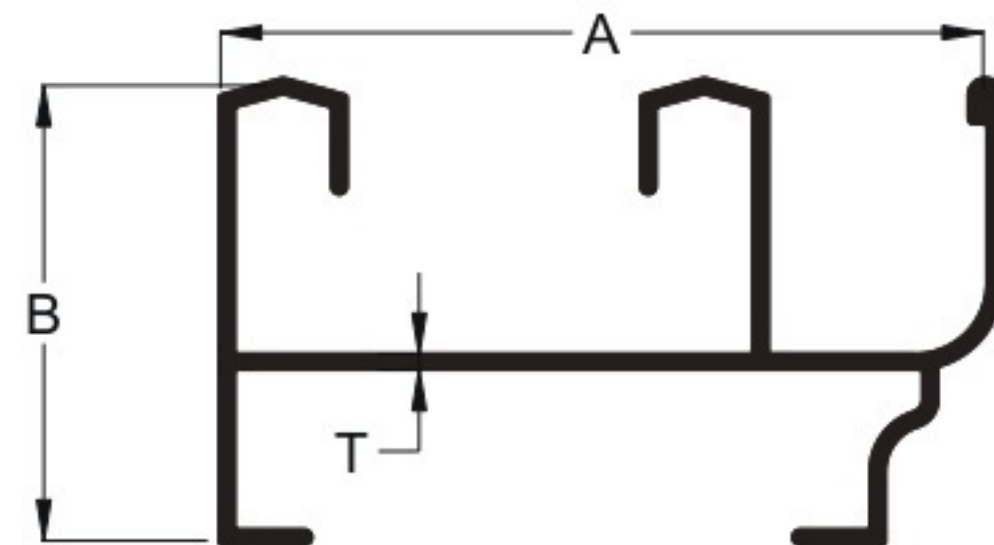

Sr. No	Section No.	A (mm)	B (mm)	T (mm)	Weight(Kg./Mtr)	Weight(Kg./12')
1	6164	67.0	40.0	1.4	0.814	2.980-3.180

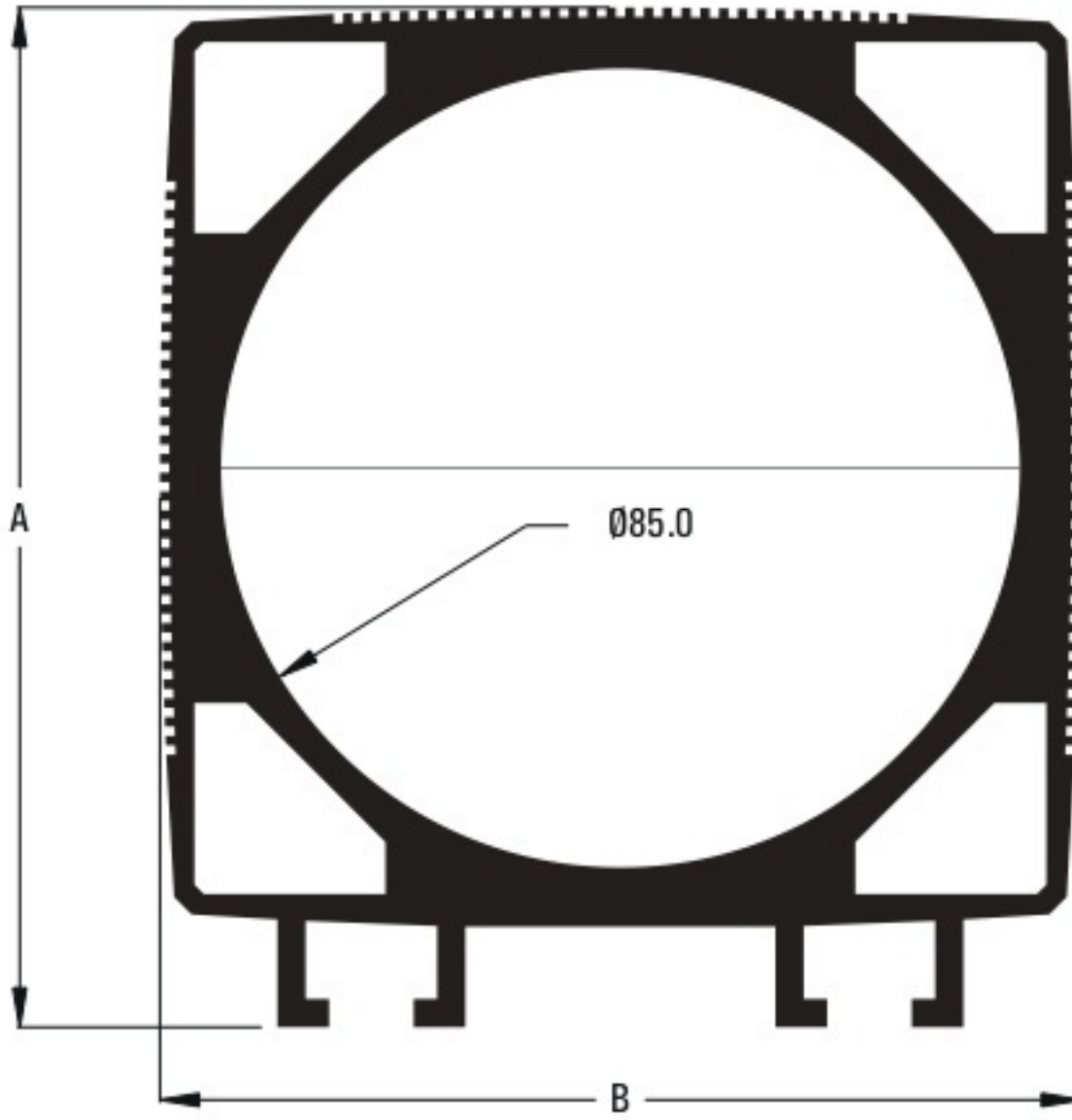

Sr. No	Section No.	A (mm)	B (mm)	T (mm)	Weight(Kg./Mtr)	Weight(Kg./12')
1	6165	98.0	95.0	---	7.108	26.000-26.500

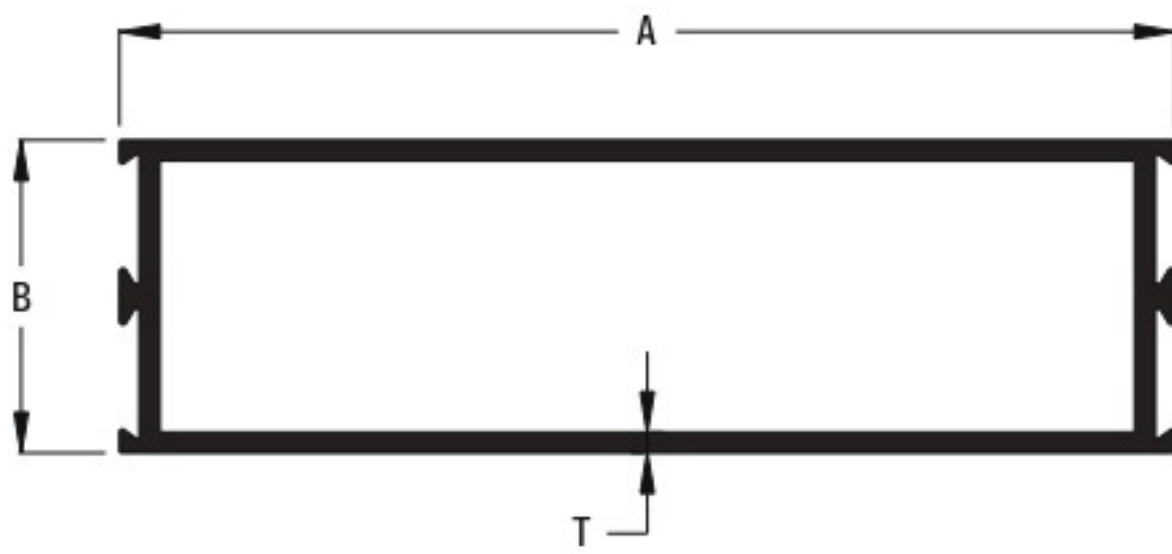

Sr. No	Section No.	A (mm)	B (mm)	T (mm)	Weight(Kg./Mtr)	Weight(Kg./12')
1	2312	150.0	44.6	2.90	3.062	11.200-11.500

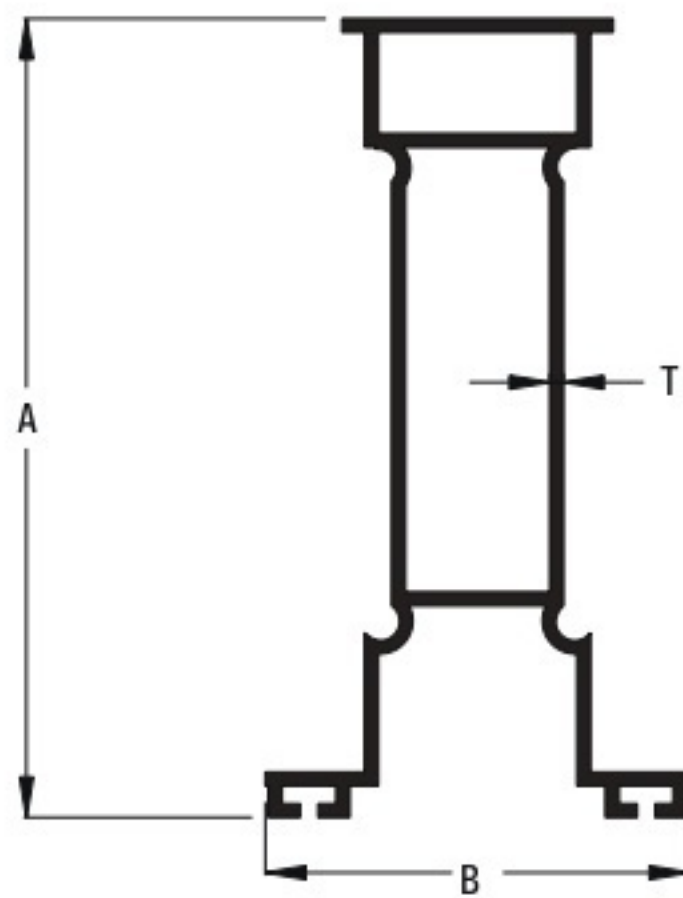

Sr. No	Section No.	A (mm)	B (mm)	T (mm)	Weight(Kg./Mtr)	Weight(Kg./12')
1	6167	88.4	47.0	1.5	1.162	4.250-4.550

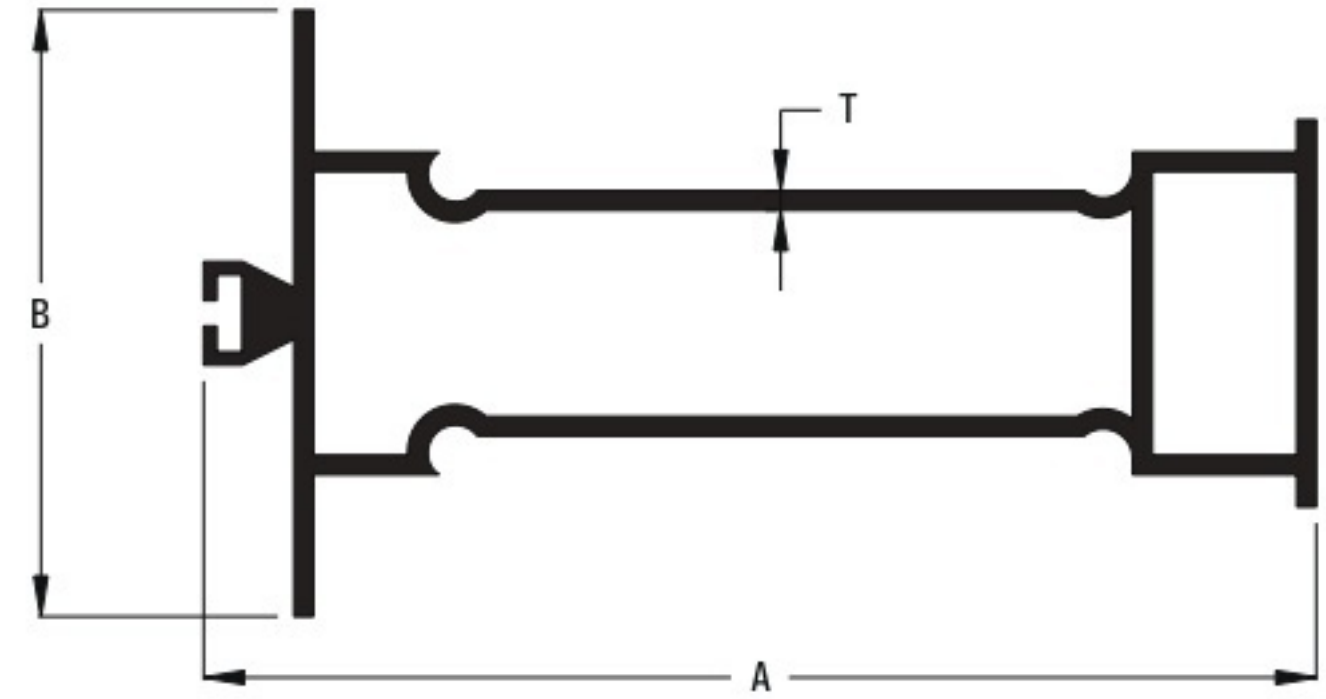

Sr. No	Section No.	A (mm)	B (mm)	T (mm)	Weight(Kg./Mtr)	Weight(Kg./12')
1	6168	86.22	47.0	1.50	1.140	4.170-4.470

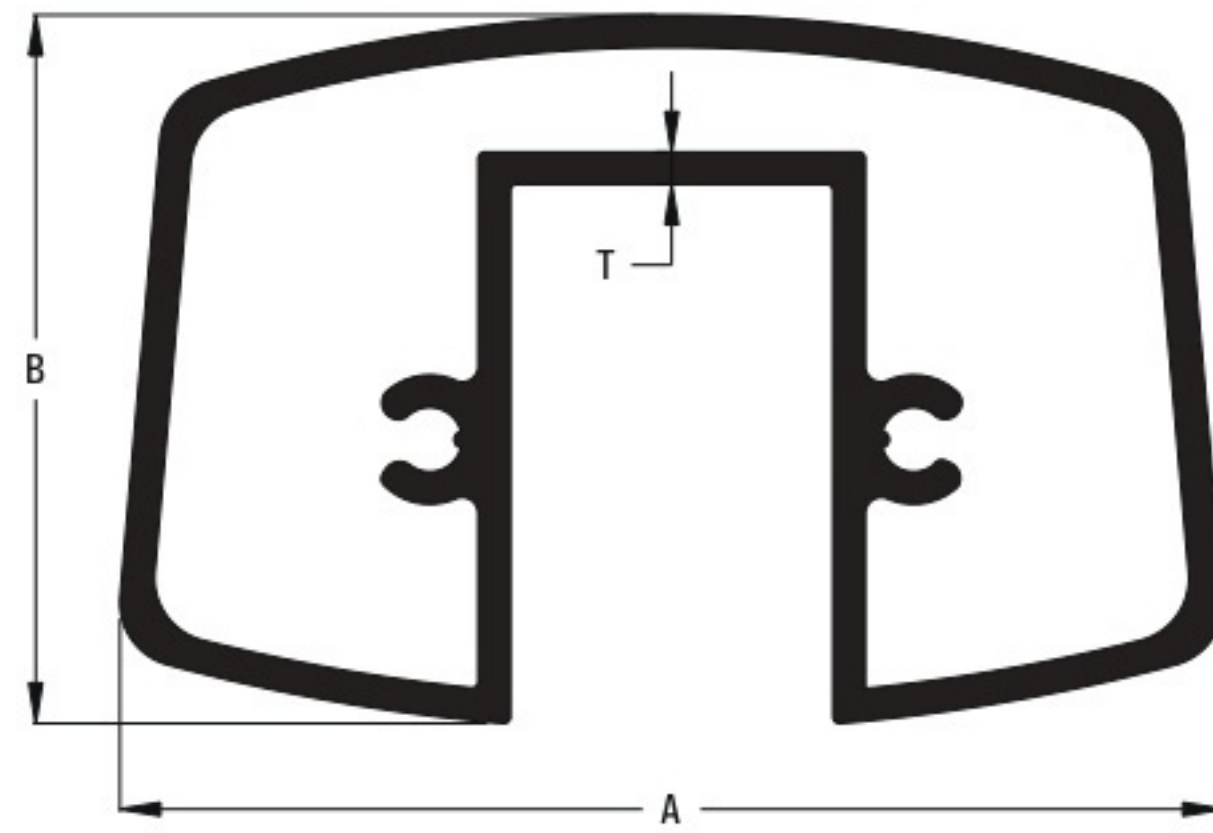

Sr. No	Section No.	A (mm)	B (mm)	T (mm)	Weight(Kg./Mtr)	Weight(Kg./12')
1	6169	68.38	43.93	2.0	1.572	5.750-6.000

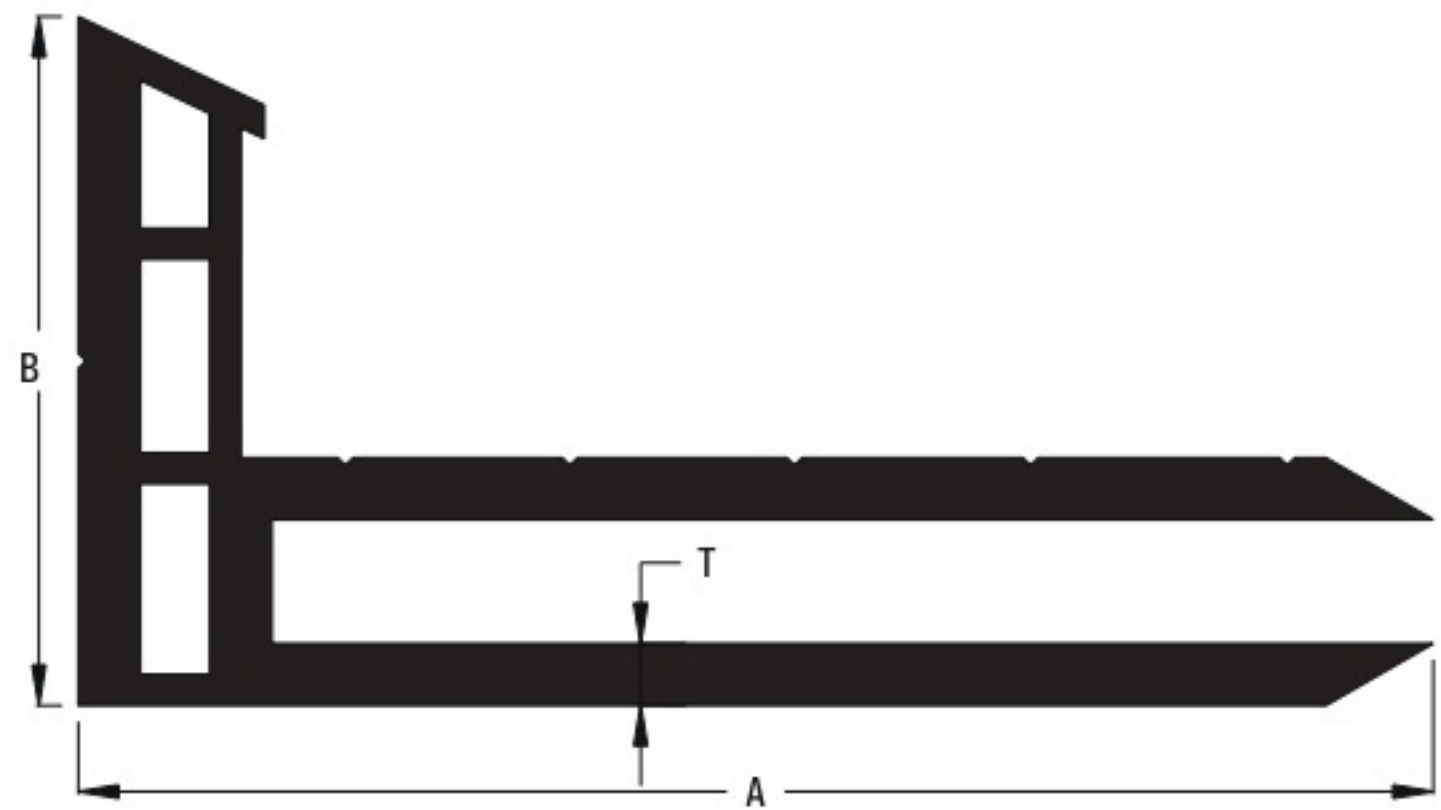

Sr. No	Section No.	A (mm)	B (mm)	T (mm)	Weight(Kg./Mtr)	Weight(Kg./12')
1	6170	175.0	89.0	8.0	9.692	35.450-35.950

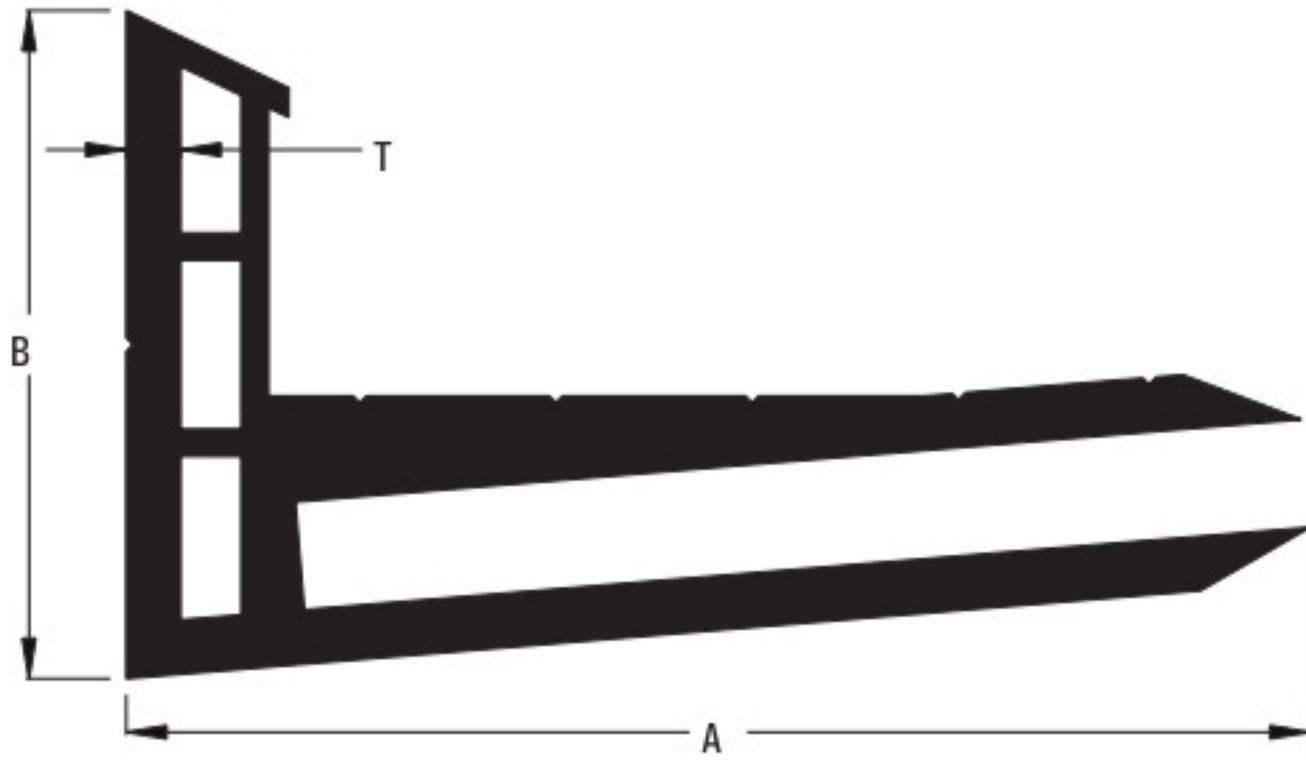

Sr. No	Section No.	A (mm)	B (mm)	T (mm)	Weight(Kg./Mtr)	Weight(Kg./12')
1	6171	175.0	98.84	8.0	11.073	40.500-41.000

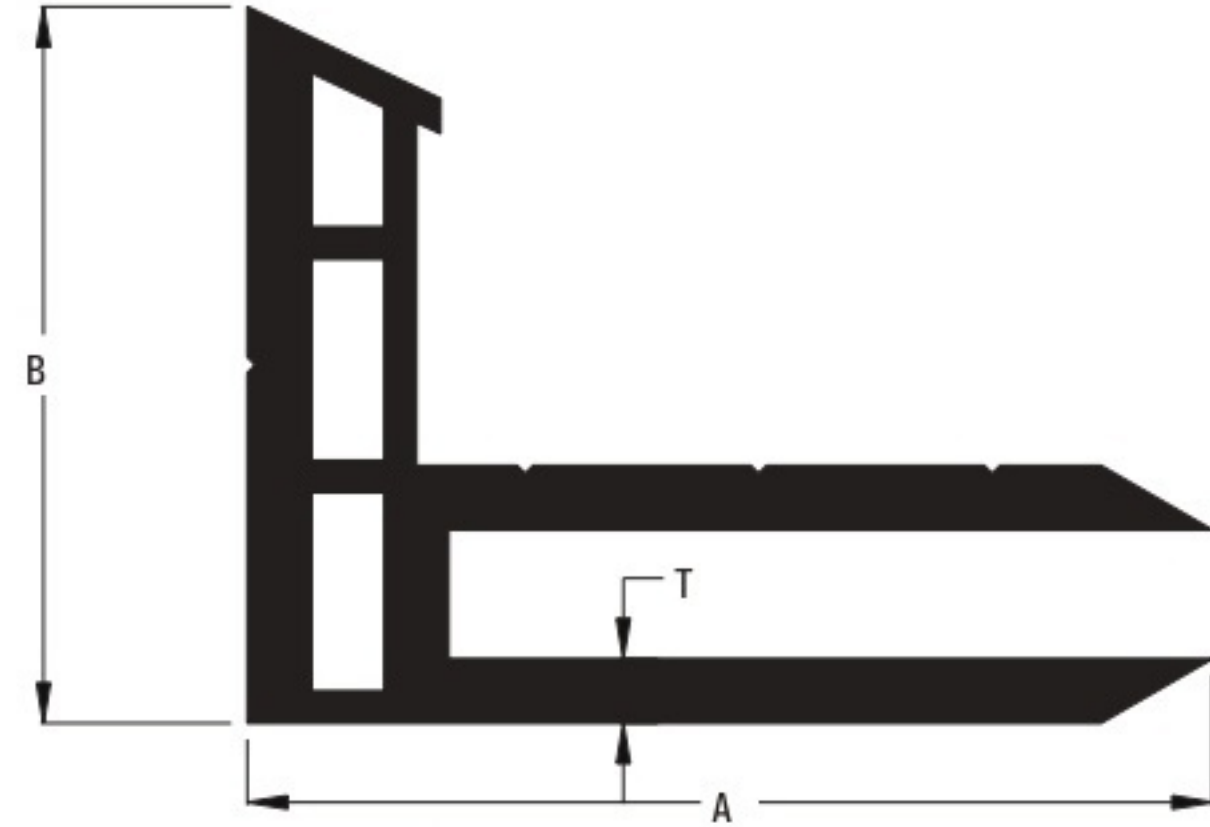

Sr. No	Section No.	A (mm)	B (mm)	T (mm)	Weight(Kg./Mtr)	Weight(Kg./12')
1	6174	119.9	89.0	8.0	7.314	26.750-27.050



Sr. No	Section No.	A (mm)	B (mm)	T (mm)	Weight(Kg./Mtr)	Weight(Kg./12')
1	6172	120.0	19.0	2.20	0.929	3.400-3.600

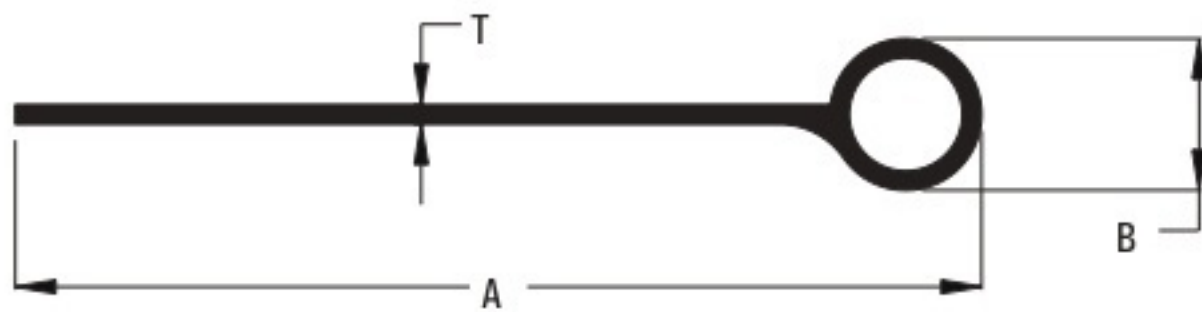

Sr. No	Section No.	A (mm)	B (mm)	T (mm)	Weight(Kg./Mtr)	Weight(Kg./12')
1	6173	100.0	15.70	2.20	0.697	2.550-2.750

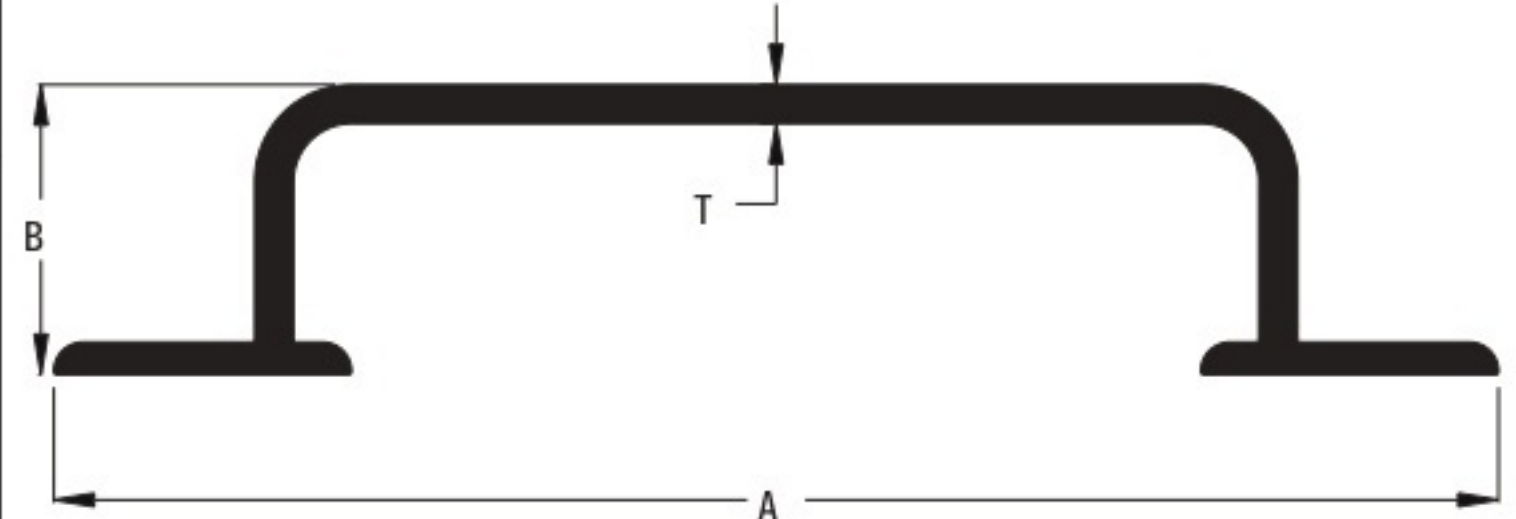

Sr. No	Section No.	A (mm)	B (mm)	T (mm)	Weight(Kg./Mtr)	Weight(Kg./12')
1	3828	149.50	30.0	4.00	2.119	7.750-8.000

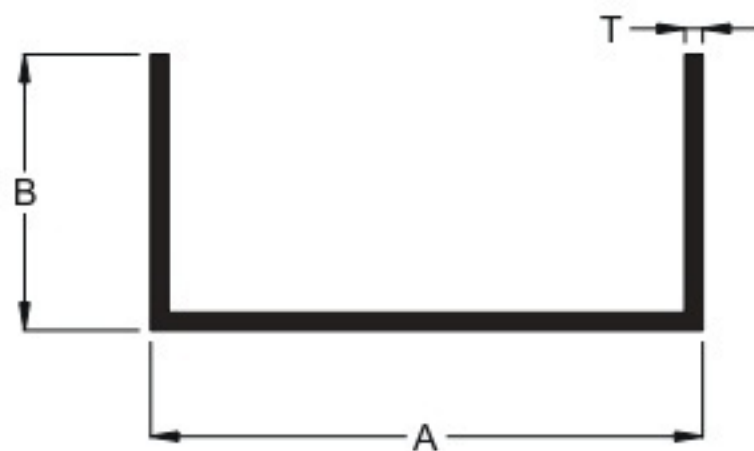

Sr. No	Section No.	A (mm)	B (mm)	T (mm)	Weight(Kg./Mtr)	Weight(Kg./12')
1	6197	50.0	25.0	1.6	0.437	1.600-1.700