



# APURVI INDUSTRIES

*The quality you can trust*

SUPPLIERS OF PROCESSED ALUMINIUM TUBES,  
PIPES, STRUCTURES & PROFILES FOR ALL TYPE OF USES





## ABOUT COMPANY



**Apurvi Industries** Supplies solutions and Quality products. We are Suppliers of aluminium for all sectors such as Aluminium Extrusion Products like Aluminium Drop Round Tubes, Square Tube, Bar, Aluminium Parts for Fueling Industries, Profiles for All type of Doors and Windows, Curtains, Blinds, Shutters and for Structures, Sections, Solids & Heating elements, Facades, etc.

Aluminium has been an integral part of industry since the beginning of the 20th century. Due to its low density, high strength and good corrosion resistance, aluminium is the ecological and economical solution for many different applications for many Industries.

## WE ARE ISO CERTIFIED

We are an ISO 9001 : 2015 Certified company that follows total Quality Management System

## THE VISION

We offer always optimal solutions for companies all over the world. Our aim is to deliver right solutions for customer demanding applications & qualitative product supply.

our mission is to provide superior quality of all aluminium extrusions & Products, aluminium tubes and profiles in straight lengths, bent, machined, with and without surface treatment, fabrications and outstanding individualized customer service

### **"WE VALUE FOR STRONG, LONG-TERM BUSINESS RELATIONSHIPS."**

We are fully geared with the requisite technical expertise and quality control mechanism, which leads us to successfully meet even the bulk orders of the clients. Additionally, our streamlined administration, regular customer service follow-ups from Back Office with the clients and quick order dispatch updating has enabled us to win the faith and trust of The clients.

Right product for the right requirement at the right price This has resulted in close ties with major customers within India & World-wide. We are committed to elevate the standards of our products and services to offer customer satisfaction through excellence in quality. Every employee is dedicated toward this aim and every measure and care is taken to ensure production of superior products, quality packaging, timely delivery, competent prices and excellent after sales service.



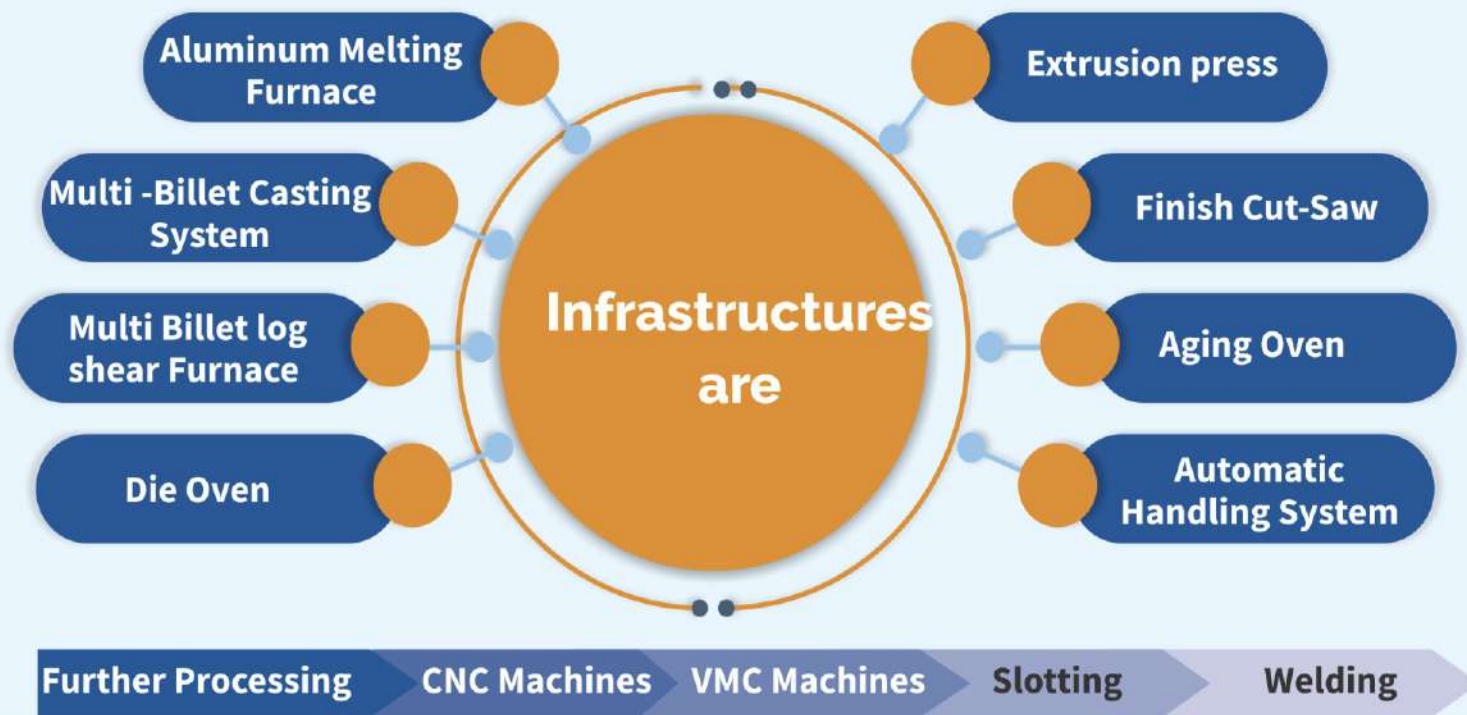

**Our high-quality and customized products for various industries, including the aviation industry, the automotive industry and both the mechanical and plant engineering industries.**

**Aluminium extrusions are commonly used in the electrical industry for bus bars, heat sinks, and other applications.**

- ▶ Aluminium extrusions are commonly used in the construction industry due to their lightweight, high strength, and corrosion resistance. They can be found in Sliding systems, blinds, window frames, Shutters, door frames, curtain walls, and roofing systems.
- ▶ Aluminium extrusions are increasingly being used in the renewable energy sector, solar panel frames and wind turbine components
- ▶ A large selection of standard profiles such as flat bars, L-profiles, U profiles, T-profiles, Z-profiles and I-profiles are available
- ▶ Drop tubes for Fueling transportation, Overfill preservation valve, Restrictor plug, Poppet vapour valve, Poppet vapour valve, Square and rectangular tube for Furniture's among other applications.
- ▶ Our robust aluminium profiles can be used practically anywhere, especially where structures are set up simply, efficiently and visually appealing - for example in automation, mechanical engineering, Furniture, Constructions, special machine construction or in the transport industry.



**Aluminium Motor Body**

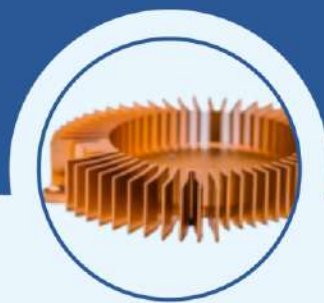

**Aluminium Fins with anodizing**



**Aluminium Fins**



# QUALITY OF PRODUCT

The “Quality Policy” is the summary of the principles and objectives that Apurvi Industries have to achieve with a view to continuous improvement, efficiency, compliance with the requirements and satisfaction of all customers. We are constantly optimizing our quality management. We prove our performance personally every day - the high quality of our products, production processes.

## QUALITY CONTROL

In order to adjust the quality of our products to our customers' requirements, we guarantee a strict control conducted by our quality control staff.

Mechanical and chemical tests are constantly being made to ensure conformance to the appropriate quality standards of the aluminium Tubes & Parts Products.

We have hired a team of the best technical and managerial staff to achieve our & customer's goals.

Regular staff trainings with upgraded Technology constantly improve our employee's skills.

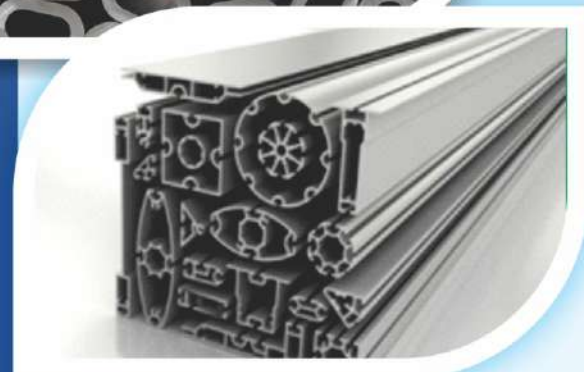

# TECHNICAL SPECIFICATION

**We have installed following machines to ensure product quality as per international standards.**

The process begins with the selection of high-quality billets and involves heating the billet to a specific temperature, then forcing it through a die under high pressure. There are two types of extrusion processes: hot and cold extrusion.

We have installed following machines to ensure product quality

**All types of grade we manufacture like 6061, 6063, 6082, etc**

▶ **UTS Machine**

▶ **Spectrometer Hardness Tester**

▶ **Webster Hardness Tester**

▶ **CMM machine**

▶ **Profile Scanner**

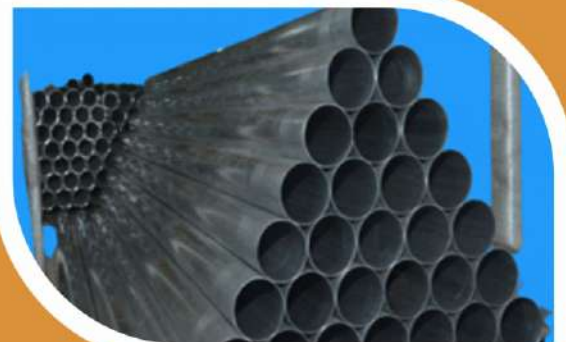
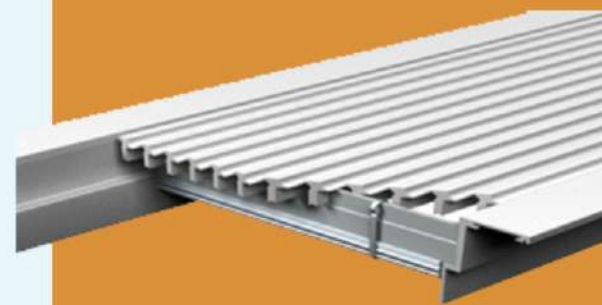



## Our Packing System

Apurvi Industries uses different packaging materials, in order to best preserve the integrity and technical properties of its products throughout the shipping and transport process.

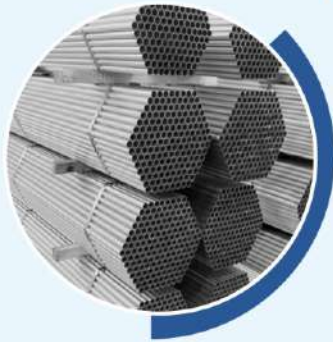

We supplied solutions to our customers

we make everything possible together with our strong partner companies, we can really implement (almost) all requirements. Just contact us and get an initial assessment from us today.

## Aluminium Profile & Other Products Photos :





# Aluminium Profile



**Blinds**



**Different shapes  
Tube Profiles**



**Aluminium profiles**

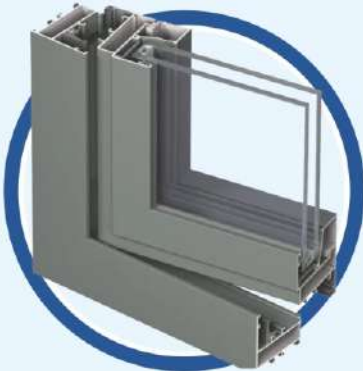

**Thermally broken profile/  
Joinery/Corner Window**



**Curtains**

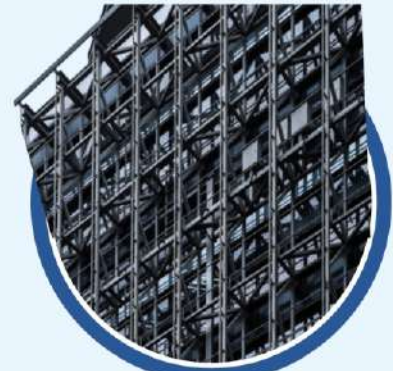

**Building Constructions**

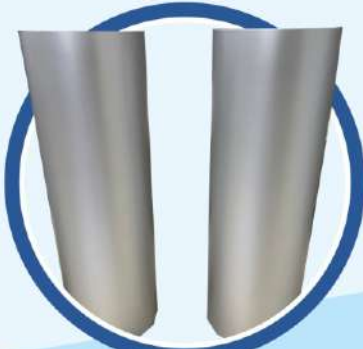

**Clear Anodize Tubes**



**Railings**



**Shutters**

## Bushings



All sizes are available on our Website Catalog. We cannot print here because of more than 100 pages





“ We have happy customers and that’s what matters to us.”



**Corporate Office :**

G-1112, Titanium City Center, 1000 Ft. Ring Road, Anandnagar,  
Ahmedabad-25, Gujarat, India.

**Plant Address :**

Survey No. 1383/D/Paiki 1,  
Village - Rajpur, Taluka : Kadi, Dist. : Mehsana Pin : 382715, Gujarat, India.



+91 81286 64329  
+91 81286 65338



sales.india@apurviind.com  
qc@apurviind.com



www.apurviind.com