



The quality you can trust



Engineered to Perfection



AN ISO 9001:2015 Certified Company

Corporate Office:-

Survey No. - 1383/D/Paiki 1 Village - Rajpur, Taluka - Kadi,

Dist - Mehsana Pin code : 382715 Phone: (0)02764-

278388/89

E-mail: info@sonunird.com web: www.sonunird.com



STANDARD PROFILES

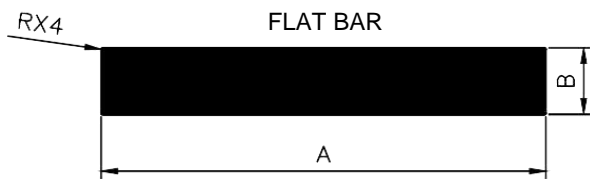

Sr.No.	Section No.	A	B	R	Wt. Kg/Mtr.
1	FBR 10054	6.00	3.00		0.048
2	FBR 90022	9.60	7.00		0.180
3	FBR 10082	10.00	6.00		0.162
4	FBR 10073	11.10	7.92		0.237
5	FBR 11484	12.00	5.00		0.161
6	FBR 11489	12.00	7.30		0.236
7	FBR 10081	12.00	9.00		0.291
8	FBR 10067	12.40	7.40		0.248
9	FBR 10080	15.00	5.50		0.222
10	FBR 10038	15.50	8.00		0.335
11	FBR 10079	16.00	10.00	3.00	0.411
12	FBR 10008	20.00	5.00		0.270
13	FBR 10076	20.00	6.00		0.324
14	FBR 10062	20.00	8.00		0.432
15	FBR 10009	20.00	10.00		0.540
16	FBR 10070	22.00	8.00		0.474
17	FBR 10066	24.60	4.00		0.265
18	FBR 10050	25.00	1.00		0.067
19	FBR 10072	25.00	3.00		0.202
20	FBR 10047	25.00	4.00		0.270
21	FBR 10004	25.00	6.00		0.405
22	FBR 10029	25.00	8.00		0.540
23	FBR 10010	25.00	10.00		0.675
24	FBR 10018	25.00	12.00		0.810
25	FBR 10086	26.00	9.00		0.632
26	FBR 90084	28.00	12.00	2.60	0.892
27	FBR 10068	28.00	25.00		1.890
28	FBR 10083	29.00	15.00		1.174
29	FBR 11532	30.00	3.00		0.243
30	FBR 10046	30.00	5.00		0.405
31	FBR 10059	30.00	6.00		0.485
32	FBR 10030	30.00	8.00		0.648
33	FBR 10011	30.00	10.00		0.810
34	FBR 10056	32.00	1.50		0.129
35	FBR 10085	32.00	7.30		0.630
36	FBR 10040	32.00	12.00		1.037
37	FBR 10045	32.00	25.00		2.160
38	FBR 10027	32.50	2.90		0.254
39	FBR 10026	35.00	3.00		0.284
40	FBR 10063	38.00	10.00	3.00	1.005
41	FBR 10064	39.80	1.50		0.160
42	FBR 10075	40.00	4.00		0.432
43	FBR 10005	40.00	6.00		0.648
44	FBR 10012	40.00	10.00		1.080
45	FBR 10019	40.00	12.00		1.296
46	FBR 10084	40.00	30.00		3.240
47	FBR 10028	44.00	1.90		0.226
48	FBR 10078	50.00	4.00		0.540
49	FBR 10039	50.00	6.00		0.810

Sr.No.	Section No.	A	B	R	Wt. Kg/Mtr.
50	FBR 10006	50.00	8.00		1.080
51	FBR 10007	50.00	10.00		1.350
52	FBR 10031	50.00	10.00	2.00	1.341
53	FBR 10020	50.00	12.00		1.620
54	FBR 10055	50.00	12.00	3.00	1.599
55	FBR 10048	50.00	25.00		3.375
56	FBR 10053	55.00	10.00		1.485
57	FBR 10077	60.00	3.50		0.566
58	FBR 10013	60.00	10.00		1.620
59	FBR 10041	60.00	12.00		1.944
60	FBR 10061	63.50	6.00	1.00	0.432
61	FBR 10003	63.50	9.52		1.632
62	FBR 10060	63.50	12.50	1.00	0.940
63	FBR 10014	75.00	10.00		2.025
64	FBR 10022	75.00	12.00		2.430
65	FBR 10034	75.00	16.00		3.240
66	FBR 10002	76.20	6.35		1.306
67	FBR 10015	80.00	10.00		2.160
68	FBR 10036	80.00	12.00		2.592
69	FBR 10023	100.00	6.00		1.620
70	FBR 10016	100.00	10.00		2.700
71	FBR 10024	100.00	12.00		3.240
72	FBR 10032	100.00	15.00	2.00	4.041
73	FBR 10071	114.30	8.00		2.468
74	FBR 10025	125.00	12.00		4.050
75	FBR 10017	150.00	10.00		4.050
76	FBR 10037	150.00	12.00		4.860



STANDARD PROFILES

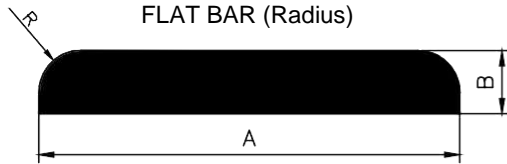

Sr.No.	Section No.	A	B	R	Wt. Kg/Mtr.
1	FBR 10033	20.00	3.00	1.50	0.159
2	FBR 10001	30.00	6.00	6.00	0.444
3	FBR 10049	32.00	12.00	4.00	1.018
4	FBR 10051	38.00	12.00	4.00	1.212

ROUND EDGE FLAT BAR

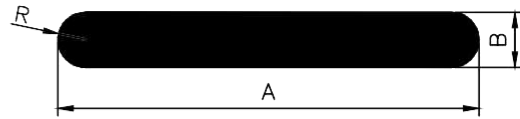

Sr.No.	Section No.	A	B	R	Wt. Kg/Mtr.
1	FBR 10052	15.00	3.65	1.83	0.140
2	FBR 10042	15.00	9.00	4.50	0.318
3	FBR 10069	50.00	12.00	6.00	1.536
4	FBR 10035	80.00	10.00	5.00	2.102
5	FBR 10057	50.00	6.00	3.00	0.789

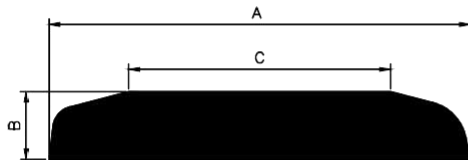

Sr.No.	Section No.	A	B	C	Wt. Kg/Mtr.
1	* FBR 10043	92.50	15.00	57.50	3.458



STANDARD PROFILES

RECTANGULAR TUBE

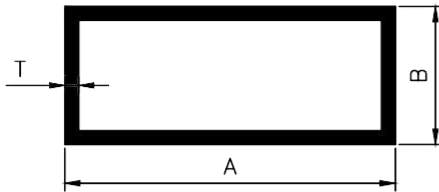

Sr.No.	Section No.	A	B	T	Wt. Kg/Mtr.
1	REI 11046	36.00	23.50	0.70	0.220
2	REI 11016	38.00	24.00	0.85	0.273
3	REI 11040	38.10	25.40	1.10	0.364
4	REI 11041	38.10	25.40	1.50	0.490
5	RET 11057	38.10	25.40	2.00	0.643
6	RET 11065	40.00	20.00	1.50	0.462
7	RET 11071	44.00	15.00	1.40	0.424
8	RET 11047	46.50	23.50	0.78	0.288
9	RET 11044	48.00	24.00	1.00	0.378
10	RET 11061	48.00	24.00	1.15	0.432
11	RET 11036	50.00	12.00	1.60	0.508
12	RET 11031	50.00	19.00	1.60	0.569
13	RET 11025	50.00	24.00	0.70	0.273
14	RET 11015	50.00	24.00	1.15	0.437
15	RET 11026	50.00	24.00	1.50	0.575
16	RET 11058	50.00	24.00	1.80	0.684
17	RET 11050	50.00	25.00	1.00	0.394
18	RET 11053	50.00	25.00	2.00	0.767
19	RET 11038	50.00	38.00	1.00	0.464
20	RET 11039	50.00	38.00	1.50	0.689
21	RET 11038/A	50.00	38.00	2.00	0.907
22	RET 16000	50.80	38.10	3.00	1.342
23	RET 11063	60.00	35.00	0.75	0.378
24	RET 11072	62.00	15.00	1.40	0.560
25	RET 11019	63.00	24.00	0.85	0.383
26	RET 11021	63.00	24.00	1.00	0.492
27	RET 11003	63.00	38.00	1.05	0.547
28	RET 11070	63.00	38.00	1.25	0.664
29	RET 11027	63.00	38.00	1.40	0.742
30	RET 11054	63.00	38.00	1.65	0.871
31	RET 11028	63.00	38.00	2.10	1.098
32	RET 11037	75.00	12.00	1.60	0.724
33	RET 11032	75.00	19.00	1.60	0.785
34	RET 11022	75.00	24.00	0.95	0.492
35	RET 11059	75.00	24.00	1.50	0.778
36	RET 16010	75.00	24.00	2.00	1.026
37	RET 11052	80.00	40.00	1.80	1.131
38	RET 11064	80.00	40.00	4.00	2.419
39	RET 11056	80.00	50.00	4.00	2.635
40	RET 11023	93.00	24.00	1.10	0.682
41	RET 11048	95.00	24.00	0.95	0.601
42	RET 11060	95.00	24.00	1.50	0.940
43	RET 11033	100.00	12.00	1.60	0.940
44	RET 11034	100.00	19.00	1.40	0.878
45	RET 11035	100.00	19.00	1.60	1.000
46	RET 11006	100.00	24.00	1.10	0.711
47	RET 16009	100.00	24.00	2.00	1.296
48	RET 11009	100.00	38.00	1.25	0.902
49	RET 11049	100.00	44.50	1.25	0.959
50	RET 11051	100.00	50.00	1.70	1.346

51	RET 11055	100.00	50.00	2.00	1.577
52	RET 11062	100.00	50.00	2.50	1.958
53	RET 11069	100.00	50.00	1.40	1.112
54	RET 11045	115.00	80.00	1.40	1.453
55	RET 11029	125.00	24.00	1.20	0.950
56	RET 11012	125.00	24.00	1.42	1.121
57	RET 11042	127.00	25.40	1.79	1.439

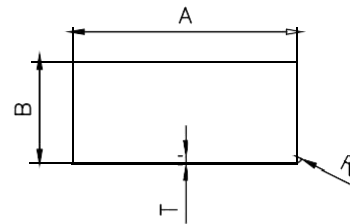

Sr.No.	Section No.	A	B	T	R	Wt. Kg/Mtr.
1	RET 16808	44.50	31.80	2.00	4.00	0.753
1	RET 11068	50.00	25.00	2.50	3.00	0.924
2	RET 11067	80.00	38.00	3.00	3.00	1.793
3	RET 11066	127.00	38.00	3.00	3.00	2.555

SPECIAL RECTANGULAR TUBE

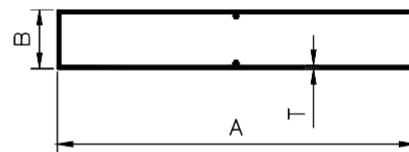

Sr.No.	Section No.	A	B	T	Wt. Kg/Mtr.
1	RET 11043	152.50	25.00	1.40	1.336

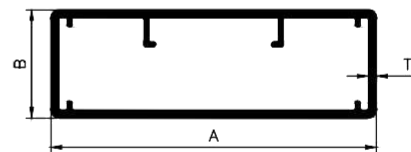

Sr.No.	Section No.	A	B	T	Wt. Kg/Mtr.
1	ART 12988	75.00	25.00	1.80	0.994

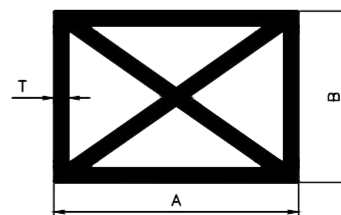

Sr.No.	Section No.	A	B	T	Wt. Kg/Mtr.
1	ART 17257/A	50.00	35.00	3.00	2.068

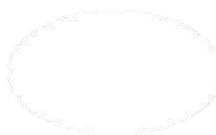

STANDARD PROFILES

ROUND TUBE

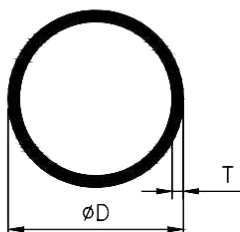

Sr.No.	Section No.	D	T	Wt. Kg/Mtr.
1	RTU 11403	9.50	1.20	0.084
2	RTU 15029	9.70	1.35	0.096
3	RTU 15030	10.80	1.40	0.112
4	RTU 13244	12.00	0.70	0.067
5	RTU 13266	12.00	1.80	0.156
6	RTU 13266/A	12.00	1.90	0.162
7	RTU 15043	12.70	1.30	0.126
8	RTU 15031	13.00	1.85	0.174
9	RTU 15014	14.60	1.45	0.162
10	RTU 13245	15.88	0.90	0.114
11	RTU 15032	16.00	2.20	0.258
12	RTU 13232	16.00	4.35	0.430
13	RTU 15018	16.00	5.25	0.478
14	RTU 15020	16.30	1.30	0.165
15	RTU 15033	17.10	2.10	0.267
16	RTU 13270	19.00	0.70	0.108
17	RTU 15002	19.00	2.00	0.288
18	RTU 13214	19.10	1.60	0.237
19	RTU 15008	19.60	2.45	0.356
20	RTU 13273	20.00	1.00	0.161
21	RTU 13264	21.00	2.50	0.392
22	RTU 15034	21.50	2.50	0.402
23	RTU 15005	23.00	0.75	0.142
24	RTU 15042	23.40	1.35	0.252
25	RTU 15035	24.00	2.70	0.488
26	RTU 13206	25.40	1.50	0.304
27	RTU 13242	25.40	1.60	0.323
28	RTU 13243	25.40	2.00	0.397
29	RTU 13260	25.40	3.00	0.570
30	RTU 15028	26.00	4.50	0.820
31	RTU 13217	26.00	6.90	1.118
32	RTU 15016	26.00	8.05	1.226
33	RTU 15024/A	27.00	5.95	1.062
34	RTU 13241	28.00	1.10	0.251
35	RTU 13265/A	28.50	8.15	1.406
36	RTU 15036	28.60	3.30	0.708
37	RTU 11402	29.00	1.20	0.283
38	RTU 13234	29.80	6.55	1.292
39	RTU 13263/A	29.90	2.60	0.602
40	RTU 15012	30.00	1.20	0.293
41	RTU 13209	30.00	6.90	1.352
42	RTU 11412	31.50	2.50	0.615
43	RTU 13253	32.00	0.90	0.237
44	RTU 15037	32.00	3.50	0.846
45	RTU 13269	32.00	4.50	1.050
46	RTU 13231	35.20	4.50	1.172
47	RTU 13256	35.40	4.90	1.268
48	RTU 13240	35.50	1.75	0.501
49	RTU 13237	37.30	1.60	0.485
50	RTU 13237/B	37.30	1.70	0.513
51	RTU 13237/A	37.30	1.80	0.542

Sr.No.	Section No.	D	T	Wt. Kg/Mtr.
52	RTU 15038	37.50	4.25	1.198
53	RTU 11401	37.80	0.90	0.282
54	RTU 15023	37.80	1.00	0.312
55	RTU 11409	38.00	1.50	0.464
56	RTU 13259	38.00	2.00	0.610
57	RTU 15017	38.00	3.00	0.890
58	RTU 15007	38.00	6.00	1.628
59	RTU 13216	38.00	7.50	1.940
60	RTU 15015/A	38.10	3.18	0.940
61	RTU 15013	39.60	2.30	0.728
62	RTU 13202	40.00	2.00	0.645
63	RTU 13262	40.00	2.50	0.795
64	RTU 13257	40.00	5.00	1.484
65	RTU 15041	40.50	7.15	2.022
66	RTU 15039	41.00	5.00	1.526
67	RTU 15021	41.00	11.50	2.878
68	RTU 13261	42.00	2.00	0.678
69	RTU 15025	42.00	7.00	2.078
70	RTU 13225	43.50	1.75	0.620
71	RTU 11404	45.00	1.50	0.553
72	RTU 15006	45.00	2.50	0.901
73	RTU 11410	45.00	10.00	2.969
74	RTU 15040	46.00	5.00	1.738
75	RTU 13210	48.00	8.50	2.848
76	RTU 13254	48.30	1.45	0.576
77	RTU 13271	50.00	0.90	0.374
78	RTU 11408	50.00	1.20	0.497
79	RTU 13203	50.00	2.00	0.814
80	RTU 13255	50.00	2.50	1.007
81	RTU 15004	50.00	3.00	1.196
82	RTU 13235	50.00	5.00	1.909
83	RTU 13211	50.00	8.00	2.850
84	RTU 11411	52.55	1.20	0.523
85	RTU 13226	53.50	1.75	0.768
86	RTU 13212	54.00	10.00	3.732
87	RTU 13268	54.00	10.50	3.874
88	RTU 13204	60.00	2.00	0.984
89	RTU 13251	60.00	2.50	1.219
90	RTU 13252	60.00	5.00	2.333
91	RTU 15026	60.00	7.50	3.340
92	RTU 15003	62.00	3.50	1.736
93	RTU 13258	63.00	1.25	0.655
94	RTU 11407	63.00	1.50	0.782
95	RTU 13246	63.00	2.95	1.503
96	RTU 13221	63.50	6.25	3.035
97	RTU 13227	67.00	2.00	1.103
98	RTU 13207	70.00	2.00	1.154
99	RTU 13233	71.00	7.00	3.800
100	RTU 13218	73.00	4.10	2.396
101	RTU 13213	73.00	5.00	2.884
102	RTU 13236	76.20	6.35	3.762
103	RTU 13205	76.25	1.65	1.044
104	RTU 13222	77.00	6.75	4.022
105	RTU 13208	80.00	2.00	1.323
106	RTU 15001	80.00	5.60	3.534
107	RTU 13215	82.20	3.00	2.015
108	RTU 15019/A	85.00	5.90	3.958
109	RTU 13228	85.50	2.75	1.930
110	RTU 15009	86.00	3.00	2.112
111	RTU 13219	89.00	4.75	3.395
112	RTU 13223/A	89.00	6.40	4.484



STANDARD PROFILES

ROUND TUBE

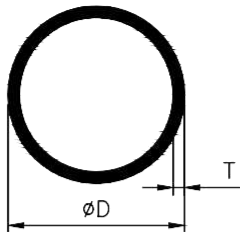

Sr.No.	Section No.	D	T	Wt. Kg/Mtr.
113	RTU 15011	95.00	4.20	3.234
114	RTU 15027/A	98.00	1.52	1.244
115	RTU 15022	98.00	2.00	1.628
116	RTU 15027	98.55	1.52	1.254
117	RTU 13230	101.60	5.00	4.097
118	RTU 13238	101.60	6.35	5.130
119	RTU 13229	105.50	2.75	2.397
120	RTU 15010	110.00	3.00	2.722
121	RTU 13220	113.50	4.25	3.938
122	RTU 13239	114.30	6.35	5.814
123	RTU 13272	120.00	3.00	2.977
124	RTU 13250	125.00	6.35	6.390

SPECIAL ROUND TUBES

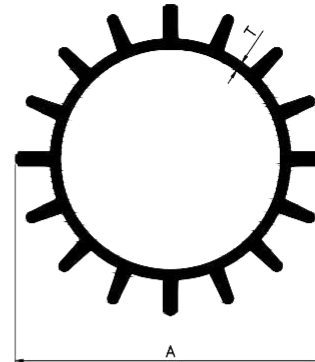

Sr.No.	Section No.	A	T	Wt. Kg/Mtr.
113	RTU 16817	65.00	2.00	1.600

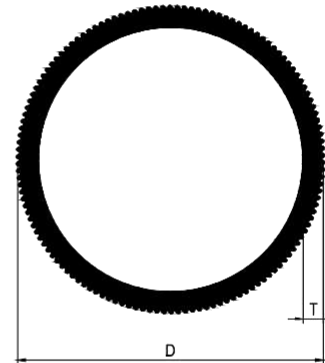

Sr.No.	Section No.	D	T	Wt. Kg/Mtr.
113	RTU 16816	64.00	4.25	2.018

STANDARD PROFILES

SPECIAL ROUND TUBES

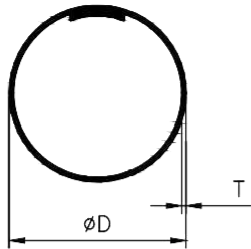

Sr.No.	Section No.	D	T	Wt. Kg/Mtr.
1	RTU 13224/A	48.30	1.45	0.661

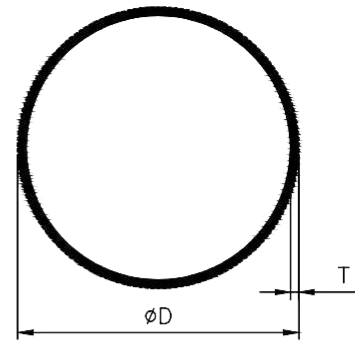

Sr.No.	Section No.	D	T	Wt. Kg/Mtr.
1	RTU 13267	102.00	3.00	2.372

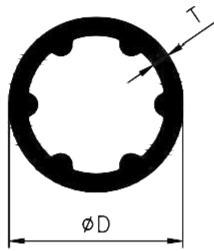

Sr.No.	Section No.	D	T	Wt. Kg/Mtr.
1	RTU 13247	63.50	6.35	3.484
2	RTU 13249	76.20	6.35	4.170

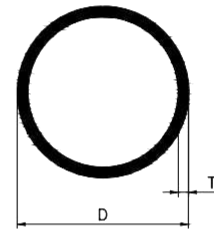

Sr.No.	Section No.	D	T	Wt. Kg/Mtr.
1	16806	40.00	2.40	0.764

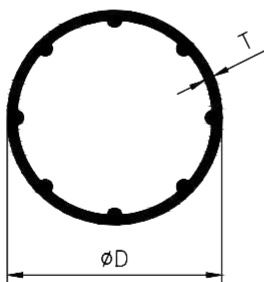

Sr.No.	Section No.	D	T	Wt. Kg/Mtr.
1	RTU 13248	101.60	6.35	5.678
1	RTU 16805	125.00	5.50	6.124

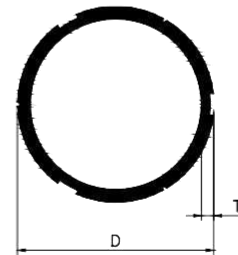

Sr.No.	Section No.	D	T	Wt. Kg/Mtr.
1	16807	40.00	2.50	0.762

STANDARD PROFILES

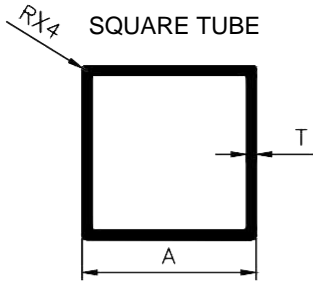

Sr.No.	Section No.	A	T	R	Wt. Kg/Mtr.
1	STU 13509	10.00	1.00	2.00	0.090
2	STU 13513	20.00	1.50		0.300
3	STU 11472	25.00	0.90		0.234
4	STU 13514	25.00	1.50		0.380
5	STU 13515	25.40	3.00		0.725
6	STU 13501	34.70	2.00		0.706
7	STU 11541	38.00	0.80		0.321
8	STU 16601	38.00	2.00		0.778
9	STU 13502	38.10	1.25		0.497
10	STU 13507	38.10	3.00		1.137
11	STU 11508	40.00	0.80		0.339
12	STU 13517	40.00	1.20		0.502
13	STU 13508	40.00	1.85		0.762
14	STU 13512	40.00	3.00		1.198
15	STU 13503	50.00	1.18		0.622
16	STU 13510	50.00	1.50		0.785
17	STU 13504	50.00	2.00		1.037
18	STU 16602	76.20	3.30		2.598
19	STU 13505	80.00	1.40		1.188

SQUARE BAR

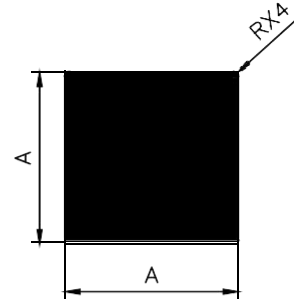

Sr.No.	Section No.	A	R	Wt. Kg/Mtr.
1	SBR 16001	10.00		0.270
2	SBR 16002	12.00		0.389
3	SBR 92601	14.00		0.528
4	SBR 16003	16.00		0.691
5	SBR 16006	19.00		0.975
6	SBR 16007	20.00	3.00	1.059
7	SBR 16004	25.00		1.687
8	SBR 16008	25.00	4.00	1.650
9	SBR 16005	32.00		2.765

SPECIAL SQUARE TUBE

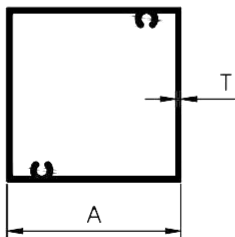

Sr.No.	Section No.	A	T	Wt. Kg/Mtr.
1	STU 13506	50.00	1.40	0.800

HEXAGONAL BAR



Sr.No.	Section No.	A	Wt. Kg/Mtr.
1	12962	6.00	0.084
2	92802	19.00	0.844
3	92803	25.00	1.461
4	16201	32.00	2.394
5	92804	38.00	3.376

STANDARD PROFILES

ROUND BAR

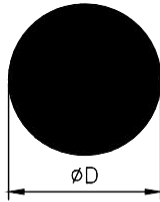

Sr.No.	Section No.	D	Wt. Kg/Mtr.
1	RBR 11312	6.00	0.076
2	RBR 92002	7.00	0.104
3	RBR 11301	8.65	0.159
4	RBR 11305	10.00	0.212
5	RBR 11306	12.00	0.305
6	RBR 92000	14.00	0.416
7	RBR 11307	16.00	0.543
8	RBR 92001	17.50	0.649
9	RBR 11316	19.00	0.766
10	RBR 11308	25.00	1.325
11	RBR 11302	25.40	1.368
12	RBR 11303	28.00	1.663
13	RBR 11310	30.00	1.909
14	RBR 11309	32.00	2.171
15	RBR 11304	36.00	2.748
16	RBR 11311	38.00	3.062
17	RBR 11314	40.00	3.393
18	RBR 11315	45.00	4.294
19	RBR 11313	50.00	5.301

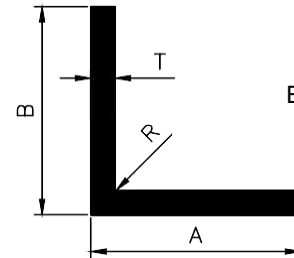

EQUAL ANGLE

Sr.No.	Section No.	A	B	R	T	Wt. Kg/Mtr.
1	ANG 13001	19.05	19.05		2.00	0.213
2	ANG 13005	25.00	25.00		3.00	0.380
3	ANG 13002	25.40	25.40		2.00	0.262
4	ANG 23011	28.00	28.00		1.60	0.234
5	ANG 12935	31.75	31.75	2.50	2.38	0.395
6	ANG 13006	38.00	38.00		1.50	0.302
7	ANG 13008	38.00	38.00		2.00	0.399
8	ANG 13007	38.00	38.00		3.00	0.591
9	ANG 13018	50.00	50.00		3.00	0.785
10	ANG 13012	50.00	50.00		5.00	1.282
11	ANG 13003	60.00	60.00		4.00	1.253
12	ANG 13004	60.00	60.00		5.50	1.700

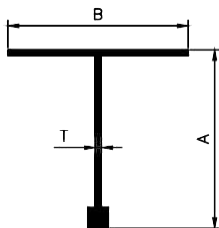

UNEQUAL ANGLE

Sr.No.	Section No.	A	B	T	Wt. Kg/Mtr.
1	ART 12163	24.00	24.00	0.80	0.116

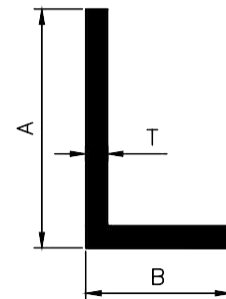

Sr.No.	Section No.	A	B	T	Wt. Kg/Mtr.
1	ANG 13013	19.00	12.00	1.50	0.119
2	ANG 13015	38.00	25.00	2.50	0.408
3	ANG 13011	96.00	48.00	1.50	0.577
4	ANG 14678	100.00	70.00	10.00	4.324

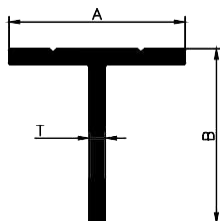

EQUAL "T" SECTION

Sr.No.	Section No.	A	B	T	Wt. Kg/Mtr.
1	ART 16401	24.00	24.00	2.20	0.270

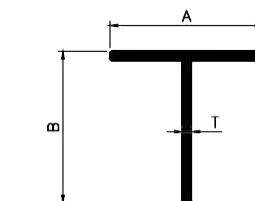

Sr.No.	Section No.	A	B	T	Wt. Kg/Mtr.
1	ART 16404	17.50	17.50	1.40	0.126
2	ART 16402	25.00	25.00	1.50	0.196
3	ART 16403	25.00	25.00	2.00	0.258

STANDARD PROFILES

"C" CHANNEL SECTION

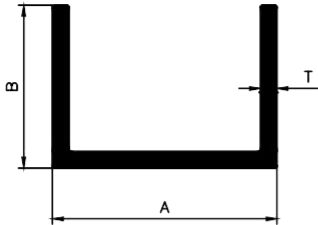

Sr.No.	Section No.	A	B	T	Wt. Kg/Mtr.
1	ART 14101	9.52	9.52	0.76	0.055
2	ART 14104	11.00	11.00	0.76	0.064
3	ART 12904	15.00	10.00	2.00	0.167
4	ART 13752	27.00	13.80	3.40	0.560
5	ART 13751	27.00	15.80	3.40	0.578
6	ART 13753	27.00	19.80	3.40	0.614
7	ART 13757	40.00	30.00	3.00	0.761

"C" CHANNEL SECTION WITH ROUND EDGE

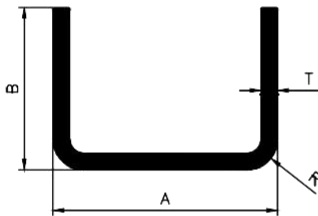

Sr.No.	Section No.	A	B	T	R	Wt. Kg/Mtr.
1	ART 13758	83.06	25.40	3.18	3.68	1.079

"E" CHANNEL SECTION

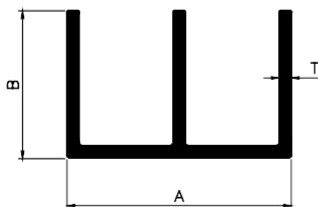

Sr.No.	Section No.	A	B	T	Wt. Kg/Mtr.
1	ART 13754	18.50	12.20	1.00	0.140
2	ART 13756	21.60	10.80	1.20	0.163

SPECIAL "C" CHANNEL SECTION

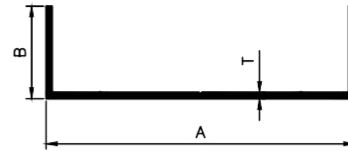

Sr.No.	Section No.	A	B	T	Wt. Kg/Mtr.
1	ART 14103/A	100.00	30.00	2.00	0.842

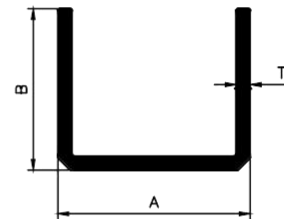

Sr.No.	Section No.	A	B	T	Wt. Kg/Mtr.
1	ART 14102	23.80	20.00	1.75	0.280

"F" CHANNEL SECTION

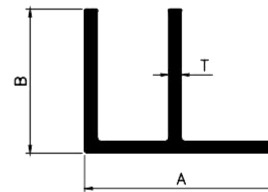

Sr.No.	Section No.	A	B	T	Wt. Kg/Mtr.
1	ART 13755	20.20	15.10	1.30	0.162

1" WINDOW SECTIONS

2 TRACK TOP

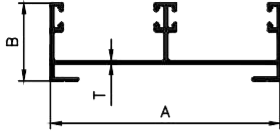

Sr.No.	Section No.	A	B	T	Wt. Kg/Mtr.
1	ART 12075	75.00	25.40	1.10	0.601

2 TRACK BOTTOM

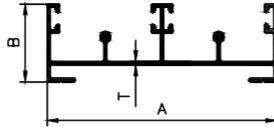

Sr.No.	Section No.	A	B	T	Wt. Kg/Mtr.
1	ART 12078	75.00	25.40	1.10	0.683

2 TRACK TOP

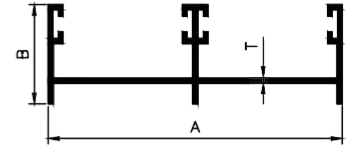

Sr.No.	Section No.	A	B	T	Wt. Kg/Mtr.
1	ART 12211	75.00	25.40	1.30	0.620

2 TRACK BOTTOM

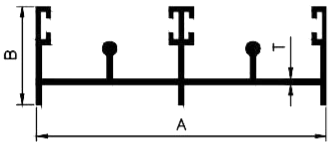

Sr.No.	Section No.	A	B	T	Wt. Kg/Mtr.
1	ART 12212	75.00	25.40	1.28	0.675
2	ART 12216	75.00	25.40	1.65	0.794

3 TRACK TOP

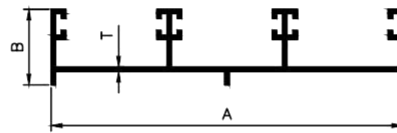

Sr.No.	Section No.	A	B	T	Wt. Kg/Mtr.
1	ART 12354	116.00	25.00	1.40	1.005
2	ART 12356	116.00	25.00	1.70	1.192

3 TRACK TOP

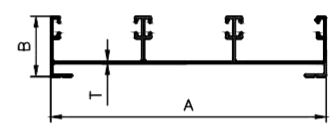

Sr.No.	Section No.	A	B	T	Wt. Kg/Mtr.
1	ART 12081	116.00	25.40	1.10	0.847

3 TRACK BOTTOM

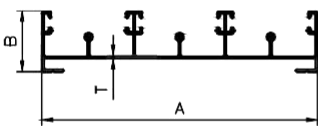

Sr.No.	Section No.	A	B	T	Wt. Kg/Mtr.
1	ART 12084	116.00	25.40	1.05	0.929

3 TRACK TOP

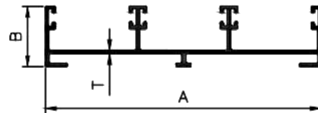

Sr.No.	Section No.	A	B	T	Wt. Kg/Mtr.
1	ART 12357	116.00	25.40	1.05	0.930
2	ART 12351	116.00	25.40	1.10	0.840
3	ART 12119	116.00	25.40	1.35	0.960

3 TRACK BOTTOM

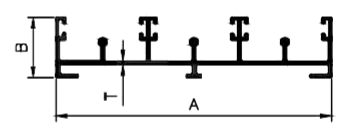

Sr.No.	Section No.	A	B	T	Wt. Kg/Mtr.
1	ART 12355	116.00	25.00	1.35	1.161
2	ART 12118	116.00	25.40	1.40	1.135

4 TRACK TOP

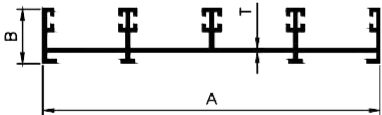

Sr.No.	Section No.	A	B	T	Wt. Kg/Mtr.
1	ART 12451	155.00	25.00	1.50	1.437

4 TRACK BOTTOM

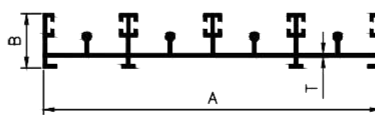

Sr.No.	Section No.	A	B	T	Wt. Kg/Mtr.
1	ART 12452	155.00	25.00	1.50	1.670

3 TRACK BOTTOM

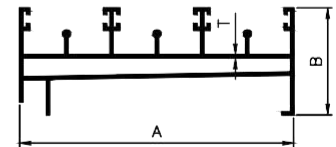

Sr.No.	Section No.	A	B	T	Wt. Kg/Mtr.
1	ART 12501	116.00	45.50	1.30	1.619



1" WINDOW SECTIONS

BEARING BOTTOM

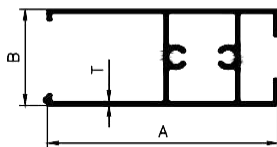

Sr.No.	Section No.	A	B	T	Wt. Kg/Mtr.
1	ART 12087	60.00	25.00	1.10	0.601
2	ART 12117	60.00	25.00	1.30	0.692
3	ART 12657	60.00	25.00	1.45	0.781

MIDDLE

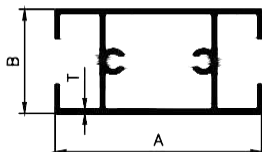

Sr.No.	Section No.	A	B	T	Wt. Kg/Mtr.
1	ART 12096	50.00	25.00	1.10	0.547

TOP BOTTOM

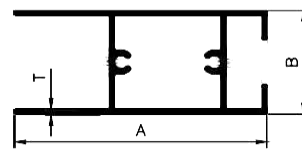

Sr.No.	Section No.	A	B	T	Wt. Kg/Mtr.
1	ART 17216	50.00	25.00	1.20	0.563
2	ART 12197	80.00	25.00	1.50	0.967

HANDLE

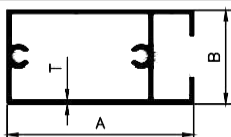

Sr.No.	Section No.	A	B	T	Wt. Kg/Mtr.
1	ART 12667	50.00	25.00	0.80	0.397
2	ARI 12091	50.00	25.00	0.90	0.437
3	ART 12093	50.00	25.00	1.15	0.547
4	ART 12115	50.00	25.00	1.33	0.615
5	ART 12655	43.00	25.00	1.98	0.833
6	ART 12680	43.50	25.50	1.30	0.578

HANDLE

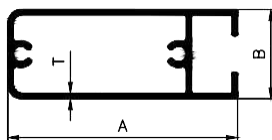

Sr.No.	Section No.	A	B	T	Wt. Kg/Mtr.
1	ART 12198	65.00	25.00	1.50	0.833

INTER LOCK

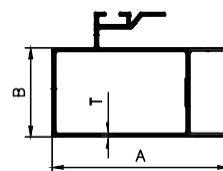

Sr.No.	Section No.	A	B	T	Wt. Kg/Mtr.
1	ART 12090	50.00	25.00	1.15	0.601
2	ART 12116	50.00	25.00	1.30	0.657

INTER LOCK

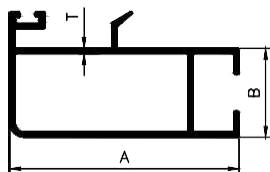

Sr.No.	Section No.	A	B	T	Wt. Kg/Mtr.
1	ARI 12199	65.00	25.00	1.50	0.893

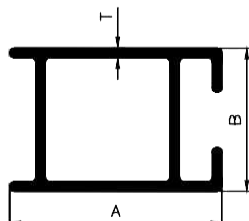

Sr.No.	Section No.	A	B	T	Wt. Kg/Mtr.
1	ART 12652	45.00	30.00	2.00	0.845

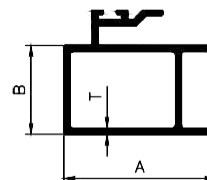

Sr.No.	Section No.	A	B	T	Wt. Kg/Mtr.
1	ART 12656	43.00	25.00	1.70	0.803

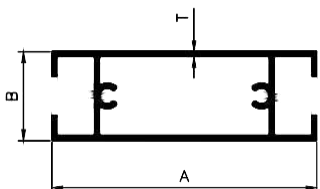

Sr.No.	Section No.	A	B	T	Wt. Kg/Mtr.
1	ART 12734	75.00	25.00	1.00	0.647
2	ARI 12695	75.00	25.00	1.40	0.896

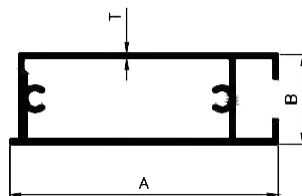

Sr.No.	Section No.	A	B	T	Wt. Kg/Mtr.
1	ART 12696	75.00	25.00	1.40	0.895

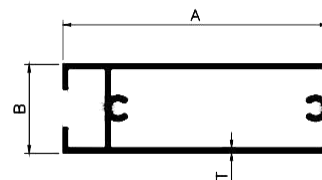

Sr.No.	Section No.	A	B	T	Wt. Kg/Mtr.
1	ART 12735	75.00	25.00	1.00	0.614
1	ART 12701	75.00	25.00	1.30	0.800

1" SPECIAL WINDOW SERIES

CURVE HANDLE

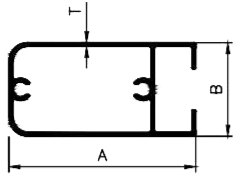

Sr.No.	Section No.	A	B	T	Wt. Kg/Mtr.
1	ART 17215	50.00	25.00	1.20	0.553

CURVE INTER LOCK

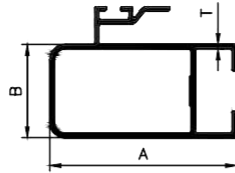

Sr.No.	Section No.	A	B	T	Wt. Kg/Mtr.
1	ART 12712	50.00	25.00	1.20	0.607

HANDLE

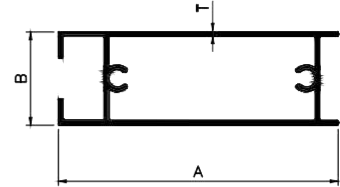

Sr.No.	Section No.	A	B	T	Wt. Kg/Mtr.
1	ART 12713	75.00	25.00	1.20	0.740

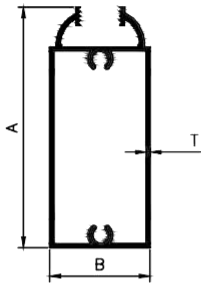

Sr.No.	Section No.	A	B	T	Wt. Kg/Mtr.
1	ART 12166/A	60.00	25.00	1.10	0.560
2	ART 12714	60.00	25.00	2.50	1.203

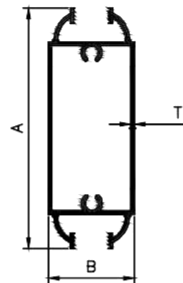

Sr.No.	Section No.	A	B	T	Wt. Kg/Mtr.
1	ART 12167/A	70.00	25.00	1.10	0.629

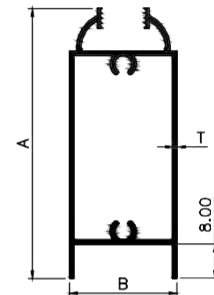

Sr.No.	Section No.	A	B	T	Wt. Kg/Mtr.
1	ART 12719/B	60.00	25.00	1.10	0.552

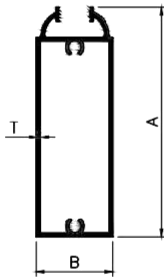

Sr.No.	Section No.	A	B	T	Wt. Kg/Mtr.
1	12707/A	75.00	25.00	1.10	0.643

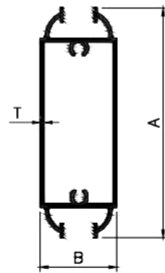

Sr.No.	Section No.	A	B	T	Wt. Kg/Mtr.
1	12708	75.00	25.00	1.20	0.694

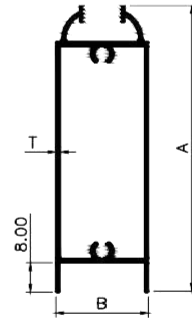

Sr.No.	Section No.	A	B	T	Wt. Kg/Mtr.
1	ART 12720/B	75.00	25.00	1.10	0.644

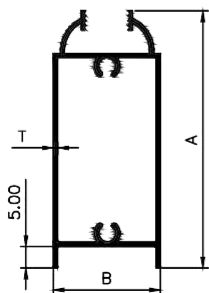

Sr.No.	Section No.	A	B	T	Wt. Kg/Mtr.
1	ART 12664	60.00	25.00	1.00	0.517

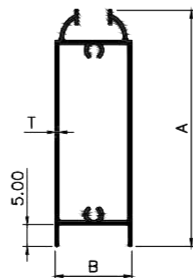

Sr.No.	Section No.	A	B	T	Wt. Kg/Mtr.
1	12709	75.00	25.00	1.20	0.684

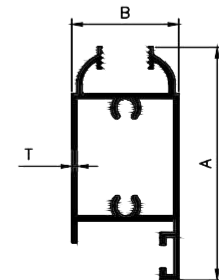

Sr.No.	Section No.	A	B	T	Wt. Kg/Mtr.
1	ART 12164	50.00	25.00	1.10	0.490

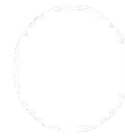

3/4" WINDOW SECTIONS

2 TRACK TOP						
Sr.No.	Section No.	A	B	T	Wt. Kg/Mtr.	
1	ART 12001	61.50	31.50	0.85	0.437	
2	ART 12003	61.50	31.50	1.05	0.547	
3	ART 12170	61.50	31.50	1.50	0.724	

2 TRACK BOTTOM						
Sr.No.	Section No.	A	B	T	Wt. Kg/Mtr.	
1	ART 12004	61.50	31.50	0.75	0.465	
2	ART 12006	61.50	31.50	0.95	0.574	
3	ART 12171	61.50	31.50	1.50	0.821	

2 TRACK TOP						
Sr.No.	Section No.	A	B	T	Wt. Kg/Mtr.	
1	ART 17211	61.50	31.50	1.20	0.637	
2	ART 12131	61.50	31.50	1.40	0.715	

2 TRACK BOTTOM						
Sr.No.	Section No.	A	B	T	Wt. Kg/Mtr.	
1	ARI 17212	61.50	31.50	1.20	0.739	
2	ARI 12132	61.50	31.50	1.50	0.867	

3 TRACK TOP						
Sr.No.	Section No.	A	B	T	Wt. Kg/Mtr.	
1	ART 12007	91.80	31.50	0.80	0.601	
2	ART 12009	91.80	31.50	1.00	0.765	
3	ART 12172	91.50	31.50	1.50	0.985	

TRACK BOTTOM						
Sr.No.	Section No.	A	B	T	Wt. Kg/Mtr.	
1	ART 12010	91.50	31.50	0.70	0.629	
2	ART 12012	91.50	31.50	0.90	0.820	
3	ART 12173	91.50	31.50	1.50	1.131	

3 TRACK TOP						
Sr.No.	Section No.	A	B	T	Wt. Kg/Mtr.	
1	ART 12362	92.00	31.75	1.20	0.871	
2	ART 12208	92.00	31.75	1.30	0.927	

3 TRACK BOTTOM						
Sr.No.	Section No.	A	B	T	Wt. Kg/Mtr.	
1	ARI 12363	92.00	31.75	1.20	1.015	
2	ART 12209	92.00	31.75	1.30	1.064	

3 TRACK TOP						
Sr.No.	Section No.	A	B	T	Wt. Kg/Mtr.	
1	ART 12352	92.00	31.75	1.00	0.734	
2	ARI 12358	92.00	31.75	1.40	1.010	

3 TRACK BOTTOM						
Sr.No.	Section No.	A	B	T	Wt. Kg/Mtr.	
1	ARI 12353	92.00	31.75	0.90	0.778	
2	ARI 12359	92.00	31.75	1.30	1.082	

4 TRACK TOP						
Sr.No.	Section No.	A	B	T	Wt. Kg/Mtr.	
1	ART 12015	122.40	31.50	1.15	1.121	

4 TRACK BOTTOM						
Sr.No.	Section No.	A	B	T	Wt. Kg/Mtr.	
1	ART 12018	122.40	31.50	1.05	1.176	

3/4" WINDOW SECTIONS

4 TRACK TOP

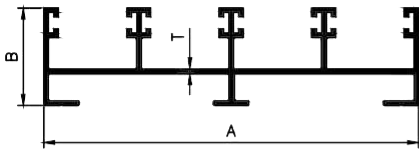

Sr.No.	Section No.	A	B	T	Wt. Kg/Mtr.
1	ART 12453/A	122.40	31.75	1.45	1.387

4 TRACK BOTTOM

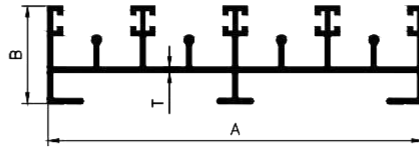

Sr.No.	Section No.	A	B	T	Wt. Kg/Mtr.
1	ART 12454/A	122.40	31.75	1.50	1.622

5 TRACK TOP

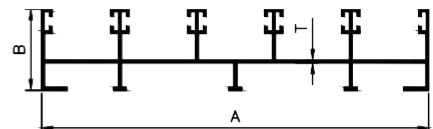

Sr.No.	Section No.	A	B	T	Wt. Kg/Mtr.
1	ART 12481	152.50	31.75	1.10	1.293

5 TRACK BOTTOM

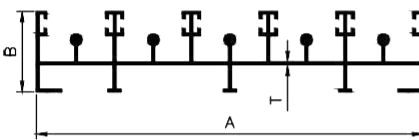

Sr.No.	Section No.	A	B	T	Wt. Kg/Mtr.
1	ART 12482	152.50	31.75	1.00	1.511

BEARING BOTTOM

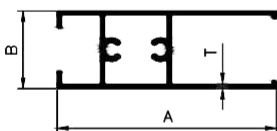

Sr.No.	Section No.	A	B	T	Wt. Kg/Mtr.
1	ART 12154	51.00	18.00	0.80	0.355
2	ART 12184	51.00	18.00	1.10	0.463
3	ART 12185	51.00	18.00	1.29	0.531

MIDDLE

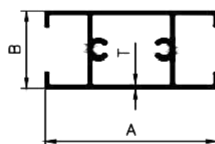

Sr.No.	Section No.	A	B	T	Wt. Kg/Mtr.
1	ART 12072	40.00	18.00	1.20	0.465

TOP BOTTOM

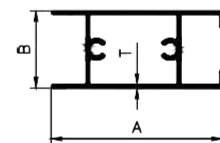

Sr.No.	Section No.	A	B	T	Wt. Kg/Mtr.
1	ARI 12153	40.00	18.00	0.77	0.273
2	ART 12069	40.00	18.00	1.00	0.355
3	ARI 12206	40.00	18.00	1.29	0.455
4	ART 12176	40.00	18.00	1.50	0.533

HANDLE

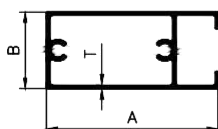

Sr.No.	Section No.	A	B	T	Wt. Kg/Mtr.
1	ART 12152	40.00	18.00	0.77	0.273
2	ART 12066	40.00	18.00	1.00	0.355
3	ART 12205	40.00	18.00	1.29	0.455
4	ART 12175	40.00	18.00	1.50	0.533

INTER LOCK

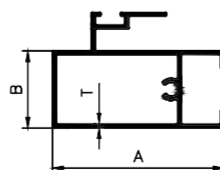

Sr.No.	Section No.	A	B	T	Wt. Kg/Mtr.
1	ART 12151	40.00	18.00	0.75	0.327
2	ART 12063	40.00	18.00	1.00	0.424
3	ART 12174	40.00	18.00	1.50	0.627

INTER LOCK

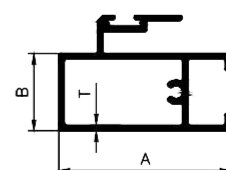

Sr.No.	Section No.	A	B	T	Wt. Kg/Mtr.
1	ART 12651	40.00	18.00	0.90	0.404
2	ART 12207	40.00	18.00	1.29	0.548

18X60mm. CURVE SERIES

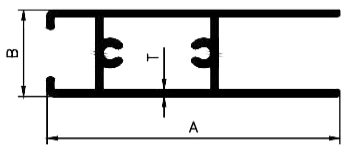
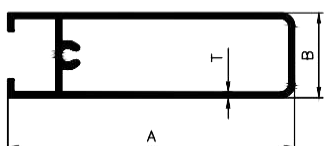
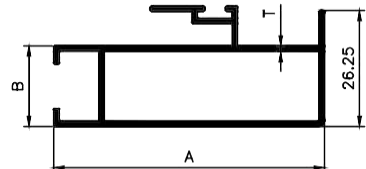
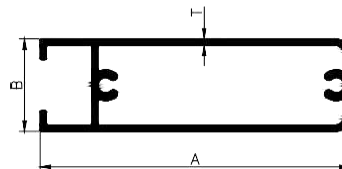
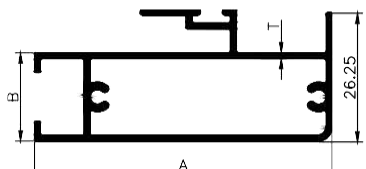
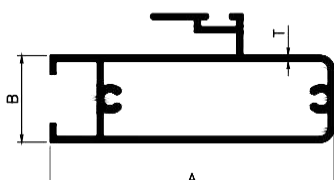
																																												
<table border="1"> <thead> <tr> <th>Sr.No.</th> <th>Section No.</th> <th>A</th> <th>B</th> <th>T</th> <th>Wt. Kg/Mtr.</th> </tr> </thead> <tbody> <tr> <td>1</td> <td>ART 12684</td> <td>60.00</td> <td>18.00</td> <td>1.20</td> <td>0.570</td> </tr> <tr> <td>2</td> <td>ART 12134</td> <td>60.00</td> <td>18.00</td> <td>1.40</td> <td>0.648</td> </tr> </tbody> </table>	Sr.No.	Section No.	A	B	T	Wt. Kg/Mtr.	1	ART 12684	60.00	18.00	1.20	0.570	2	ART 12134	60.00	18.00	1.40	0.648	<table border="1"> <thead> <tr> <th>Sr.No.</th> <th>Section No.</th> <th>A</th> <th>B</th> <th>T</th> <th>Wt. Kg/Mtr.</th> </tr> </thead> <tbody> <tr> <td>1</td> <td>ART 12156</td> <td>60.00</td> <td>18.00</td> <td>1.20</td> <td>0.531</td> </tr> </tbody> </table>	Sr.No.	Section No.	A	B	T	Wt. Kg/Mtr.	1	ART 12156	60.00	18.00	1.20	0.531	<table border="1"> <thead> <tr> <th>Sr.No.</th> <th>Section No.</th> <th>A</th> <th>B</th> <th>T</th> <th>Wt. Kg/Mtr.</th> </tr> </thead> <tbody> <tr> <td>1</td> <td>ART 12157</td> <td>60.00</td> <td>18.00</td> <td>1.20</td> <td>0.637</td> </tr> </tbody> </table>	Sr.No.	Section No.	A	B	T	Wt. Kg/Mtr.	1	ART 12157	60.00	18.00	1.20	0.637
Sr.No.	Section No.	A	B	T	Wt. Kg/Mtr.																																							
1	ART 12684	60.00	18.00	1.20	0.570																																							
2	ART 12134	60.00	18.00	1.40	0.648																																							
Sr.No.	Section No.	A	B	T	Wt. Kg/Mtr.																																							
1	ART 12156	60.00	18.00	1.20	0.531																																							
Sr.No.	Section No.	A	B	T	Wt. Kg/Mtr.																																							
1	ART 12157	60.00	18.00	1.20	0.637																																							
																																												
<table border="1"> <thead> <tr> <th>Sr.No.</th> <th>Section No.</th> <th>A</th> <th>B</th> <th>T</th> <th>Wt. Kg/Mtr.</th> </tr> </thead> <tbody> <tr> <td>1</td> <td>ART 12685</td> <td>60.00</td> <td>18.00</td> <td>1.20</td> <td>0.565</td> </tr> </tbody> </table>	Sr.No.	Section No.	A	B	T	Wt. Kg/Mtr.	1	ART 12685	60.00	18.00	1.20	0.565	<table border="1"> <thead> <tr> <th>Sr.No.</th> <th>Section No.</th> <th>A</th> <th>B</th> <th>T</th> <th>Wt. Kg/Mtr.</th> </tr> </thead> <tbody> <tr> <td>1</td> <td>ART 12686</td> <td>60.00</td> <td>18.00</td> <td>1.20</td> <td>0.700</td> </tr> </tbody> </table>	Sr.No.	Section No.	A	B	T	Wt. Kg/Mtr.	1	ART 12686	60.00	18.00	1.20	0.700	<table border="1"> <thead> <tr> <th>Sr.No.</th> <th>Section No.</th> <th>A</th> <th>B</th> <th>T</th> <th>Wt. Kg/Mtr.</th> </tr> </thead> <tbody> <tr> <td>1</td> <td>ART 12711</td> <td>60.00</td> <td>18.00</td> <td>1.20</td> <td>0.671</td> </tr> </tbody> </table>	Sr.No.	Section No.	A	B	T	Wt. Kg/Mtr.	1	ART 12711	60.00	18.00	1.20	0.671						
Sr.No.	Section No.	A	B	T	Wt. Kg/Mtr.																																							
1	ART 12685	60.00	18.00	1.20	0.565																																							
Sr.No.	Section No.	A	B	T	Wt. Kg/Mtr.																																							
1	ART 12686	60.00	18.00	1.20	0.700																																							
Sr.No.	Section No.	A	B	T	Wt. Kg/Mtr.																																							
1	ART 12711	60.00	18.00	1.20	0.671																																							

18X50mm. CURVE SERIES

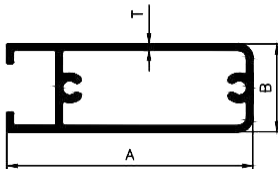
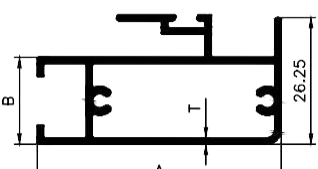
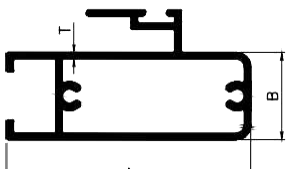
																																																		
<table border="1"> <thead> <tr> <th>Sr.No.</th> <th>Section No.</th> <th>A</th> <th>B</th> <th>T</th> <th>Wt. Kg/Mtr.</th> </tr> </thead> <tbody> <tr> <td>1</td> <td>ART 12736</td> <td>50.00</td> <td>18.00</td> <td>1.20</td> <td>0.502</td> </tr> <tr> <td>2</td> <td>ART 12665</td> <td>50.00</td> <td>18.00</td> <td>1.30</td> <td>0.534</td> </tr> </tbody> </table>	Sr.No.	Section No.	A	B	T	Wt. Kg/Mtr.	1	ART 12736	50.00	18.00	1.20	0.502	2	ART 12665	50.00	18.00	1.30	0.534	<table border="1"> <thead> <tr> <th>Sr.No.</th> <th>Section No.</th> <th>A</th> <th>B</th> <th>T</th> <th>Wt. Kg/Mtr.</th> </tr> </thead> <tbody> <tr> <td>1</td> <td>ART 12666</td> <td>50.00</td> <td>18.00</td> <td>1.30</td> <td>0.680</td> </tr> </tbody> </table>	Sr.No.	Section No.	A	B	T	Wt. Kg/Mtr.	1	ART 12666	50.00	18.00	1.30	0.680	<table border="1"> <thead> <tr> <th>Sr.No.</th> <th>Section No.</th> <th>A</th> <th>B</th> <th>T</th> <th>Wt. Kg/Mtr.</th> </tr> </thead> <tbody> <tr> <td>1</td> <td>ART 12737</td> <td>50.00</td> <td>18.00</td> <td>1.20</td> <td>0.610</td> </tr> <tr> <td>1</td> <td>ART 12710</td> <td>50.00</td> <td>18.00</td> <td>1.30</td> <td>0.648</td> </tr> </tbody> </table>	Sr.No.	Section No.	A	B	T	Wt. Kg/Mtr.	1	ART 12737	50.00	18.00	1.20	0.610	1	ART 12710	50.00	18.00	1.30	0.648
Sr.No.	Section No.	A	B	T	Wt. Kg/Mtr.																																													
1	ART 12736	50.00	18.00	1.20	0.502																																													
2	ART 12665	50.00	18.00	1.30	0.534																																													
Sr.No.	Section No.	A	B	T	Wt. Kg/Mtr.																																													
1	ART 12666	50.00	18.00	1.30	0.680																																													
Sr.No.	Section No.	A	B	T	Wt. Kg/Mtr.																																													
1	ART 12737	50.00	18.00	1.20	0.610																																													
1	ART 12710	50.00	18.00	1.30	0.648																																													

18X40mm. CURVE SERIES

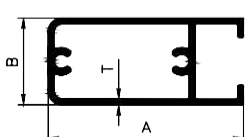
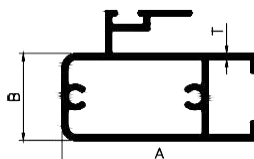
<p style="text-align: center;">HANDLE</p> 	<p style="text-align: center;">INTER LOCK</p> 																									
<table border="1"> <thead> <tr> <th>Sr.No.</th> <th>Section No.</th> <th>A</th> <th>B</th> <th>T</th> <th>Wt. Kg/Mtr.</th> </tr> </thead> <tbody> <tr> <td>1</td> <td>ART 17209</td> <td>40.00</td> <td>18.00</td> <td>1.20</td> <td>0.422</td> </tr> </tbody> </table>	Sr.No.	Section No.	A	B	T	Wt. Kg/Mtr.	1	ART 17209	40.00	18.00	1.20	0.422	<table border="1"> <thead> <tr> <th>Sr.No.</th> <th>Section No.</th> <th>A</th> <th>B</th> <th>T</th> <th>Wt. Kg/Mtr.</th> </tr> </thead> <tbody> <tr> <td>1</td> <td>ART 17210</td> <td>40.00</td> <td>18.00</td> <td>1.20</td> <td>0.511</td> </tr> </tbody> </table>	Sr.No.	Section No.	A	B	T	Wt. Kg/Mtr.	1	ART 17210	40.00	18.00	1.20	0.511	
Sr.No.	Section No.	A	B	T	Wt. Kg/Mtr.																					
1	ART 17209	40.00	18.00	1.20	0.422																					
Sr.No.	Section No.	A	B	T	Wt. Kg/Mtr.																					
1	ART 17210	40.00	18.00	1.20	0.511																					

DOOR & PARTITION SECTIONS

DOOR TOP

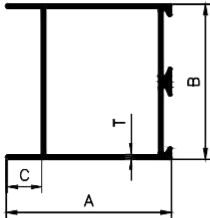

Sr.No.	Section No.	A	B	C	T	Wt. Kg/Mtr.
1	ART 12021	47.62	44.45	10.00	1.35	0.711
2	ART 12804	47.62	44.50	10.00	1.74	0.886

DOOR VERTICAL

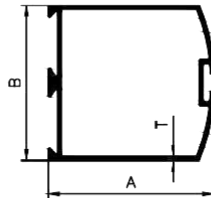

Sr.No.	Section No.	A	B	T	Wt. Kg/Mtr.
1	ART 12024	47.50	44.45	1.30	0.711
2	ART 12802	47.62	44.45	1.62	0.857
3	ART 18009	70.00	44.45	1.55	1.006
4	ART 12036	85.00	44.45	1.55	1.148
5	ART 12827	85.00	44.45	2.35	1.640
6	ART 12035	85.00	44.45	3.25	2.213

DOOR MIDDLE

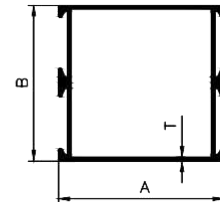

Sr.No.	Section No.	A	B	T	Wt. Kg/Mtr.
1	ART 12027	47.50	44.45	1.20	0.711
2	ART 12805	49.91	44.45	1.60	0.896
3	ART 12042	85.00	44.45	1.50	1.148
4	ART 12841	85.00	44.45	2.00	1.444
5	ART 12830	85.00	44.45	2.35	1.663

DOOR SINGLE

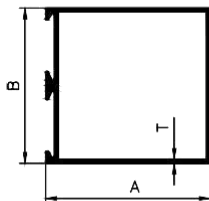

Sr.No.	Section No.	A	B	T	Wt. Kg/Mtr.
1	ART 12030	47.50	44.45	1.33	0.711
2	ART 12803	47.62	44.45	1.74	0.879
3	ART 18010	70.00	44.45	1.45	0.926
4	ART 12041	85.00	44.45	1.45	1.039
5	ART 12039	85.00	44.45	1.60	1.148
6	ART 12839	85.00	44.45	2.00	1.399
7	ART 12829	85.00	44.45	2.35	1.623

DOOR BOTTOM

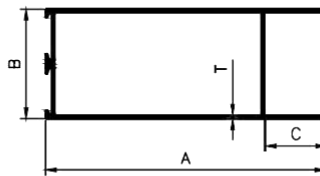

Sr.No.	Section No.	A	B	C	T	Wt. Kg/Mtr.
1	ART 18008	70.00	44.45	10.00	1.60	0.996
2	ART 12033	85.00	44.45	10.00	1.60	1.148
3	ART 12838	85.00	44.45	10.00	2.00	1.399
4	ART 12828	85.00	44.45	10.00	2.35	1.623
5	ART 12202	95.00	44.45	25.00	1.85	1.415
6	ART 12831	95.00	44.45	25.00	2.35	1.760
7	ART 12045	114.30	44.45	25.00	1.43	1.258

CORNER GLAZING PARTITION

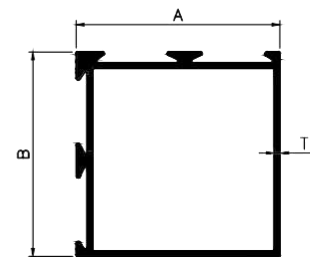

Sr.No.	Section No.	A	B	T	Wt. Kg/Mtr.
1	18012	47.50	47.50	1.33	0.795

SINGLE PARTITION

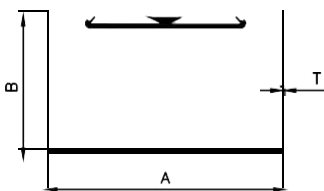

Sr.No.	Section No.	A	B	T	Wt. Kg/Mtr.
1	ART 12808	50.80	25.40	0.91	0.418
2	ART 12836	50.80	25.40	1.20	0.534
3	ART 12179	63.50	38.00	0.80	0.492
4	ART 12052	63.50	38.00	0.90	0.547
5	ART 12821	63.50	38.00	1.03	0.614
6	ART 12054	63.50	38.00	1.05	0.656
7	ART 12121	63.50	38.00	1.30	0.756
8	ART 12122	63.50	38.00	1.50	0.861
9	ART 12810	63.50	38.10	1.95	1.093
10	ART 12812	63.50	38.10	3.18	1.708
11	ART 12046	101.60	44.45	1.25	1.039
12	ART 12048	101.60	44.45	1.40	1.148
13	ART 12814	101.60	44.45	2.01	1.606
14	ART 12816	101.60	44.45	3.00	2.341
15	ART 12047	101.60	44.45	3.50	2.708

DOUBLE PARTITION

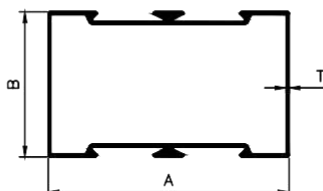

Sr.No.	Section No.	A	B	T	Wt. Kg/Mtr.
1	ART 12809	50.80	25.40	0.79	0.419
2	ART 12837	50.80	25.40	1.20	0.590
3	ART 12180	63.50	38.00	0.70	0.519
4	ART 12055	63.50	38.00	0.80	0.574
5	ART 12822	63.50	38.00	0.93	0.614
6	ART 12057	63.50	38.00	1.00	0.683
7	ART 12123	63.50	38.00	1.30	0.820
8	ART 12124	63.50	38.00	1.50	0.926
9	ART 12811	63.50	38.00	1.85	1.104
10	ART 12813	63.50	38.10	3.18	1.781
11	ART 17179	90.00	45.00	1.75	1.374
12	ART 12823	92.00	32.00	1.20	0.938
13	ART 12049	101.60	44.45	1.20	1.066
14	ART 12051	101.60	44.45	1.33	1.176
15	ART 12815	101.60	44.45	1.93	1.610
16	ART 12817	101.60	44.45	3.00	2.412
17	ART 12050	101.60	44.45	3.50	2.788

TIPS VERTICAL

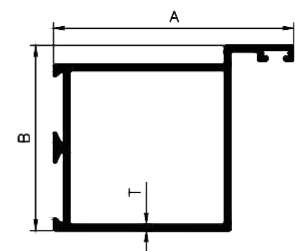

Sr.No.	Section No.	A	B	T	Wt. Kg/Mtr.
1	ART 12820	64.50	49.50	1.70	0.984

GLASS BOTTOM

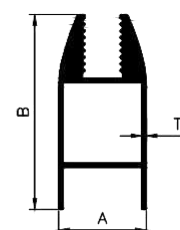

Sr.No.	Section No.	A	B	T	Wt. Kg/Mtr.
1	ART 12165	40.00	88.50	2.00	2.226

DOOR & PARTITION SECTIONS

GLAZING CLIP

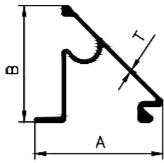

Sr.No.	Section No.	A	B	T	Wt. Kg/Mtr.
1	ARI 12801	19.00	17.30	0.35	0.060
2	ARI 12178	19.00	17.30	0.40	0.066
3	ART 12155	19.00	17.30	0.60	0.080
4	ART 12060	19.00	17.30	0.70	0.096
5	ART 12818	19.00	17.30	0.80	0.109
6	ART 12819	19.00	17.30	0.90	0.124
7	ART 12177	19.00	17.30	1.00	0.116

GLAZING CLIP

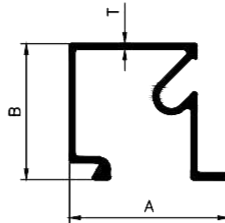

Sr.No.	Section No.	A	B	T	Wt. Kg/Mtr.
1	17073/A	19.00	17.10	0.70	0.132

GLAZING FLAT

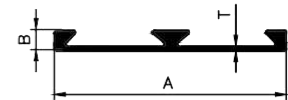

Sr.No.	Section No.	A	B	T	Wt. Kg/Mtr.
1	ART 12108	44.50	3.90	0.90	0.191
2	ART 12807	44.45	3.75	1.21	0.220

L PIPE

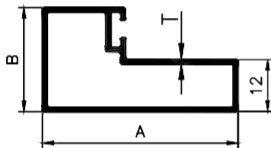

Sr.No.	Section No.	A	B	T	Wt. Kg/Mtr.
1	ARI 12100	45.00	24.00	0.85	0.328
2	ART 12102	45.00	24.00	1.10	0.437

LEG SINGLE PARTITION

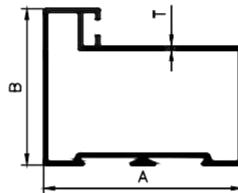

Sr.No.	Section No.	A	B	T	Wt. Kg/Mtr.
1	ARI 12099	63.50	50.00	1.37	0.929
2	ARI 12806	63.50	49.50	1.70	1.124
3	ART 12840	63.50	49.50	2.00	1.307
4	ARI 12826	63.50	49.50	2.35	1.489

LEG SINGLE PARTITION

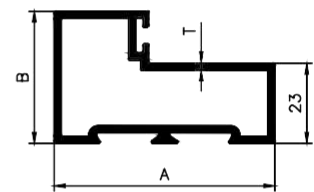

Sr.No.	Section No.	A	B	T	Wt. Kg/Mtr.
1	ART 12125	63.50	38.00	2.00	1.171

L PIPE

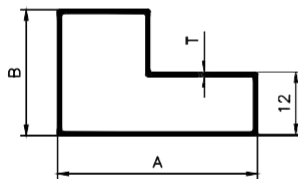

Sr.No.	Section No.	A	B	T	Wt. Kg/Mtr.
1	ART 12103	38.00	24.00	0.75	0.246
2	ARI 12105	38.00	24.00	1.05	0.342

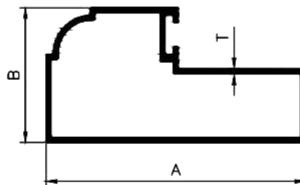

Sr.No.	Section No.	A	B	T	Wt. Kg/Mtr.
1	ARI 17057	53.00	27.50	1.00	0.438

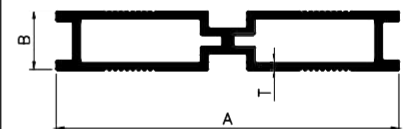

Sr.No.	Section No.	A	B	T	Wt. Kg/Mtr.
1	17234	70.00	12.00	1.50	0.701

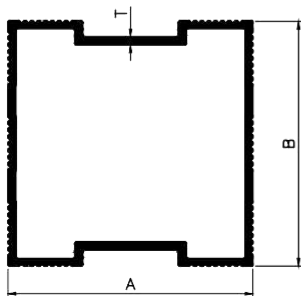

Sr.No.	Section No.	A	B	T	Wt. Kg/Mtr.
1	17235	50.00	50.00	1.60	0.832

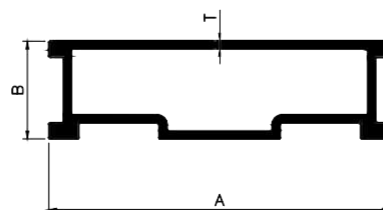

Sr.No.	Section No.	A	B	T	Wt. Kg/Mtr.
1	17236	69.70	20.00	1.60	0.851

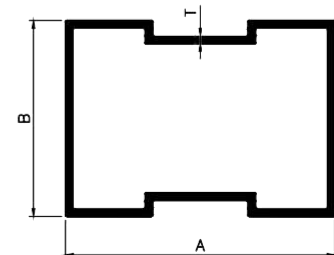

Sr.No.	Section No.	A	B	T	Wt. Kg/Mtr.
1	17237	55.00	40.00	1.50	0.798

DOOR & PARTITION SECTIONS

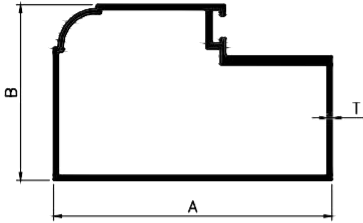

Sr.No.	Section No.	A	B	T	Wt. Kg/Mtr.
1	ART 12842/A	65.00	41.00	1.15	0.711

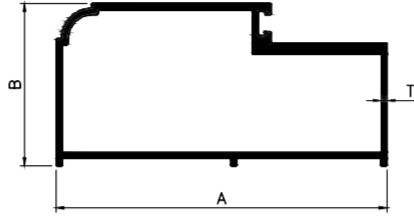

Sr.No.	Section No.	A	B	T	Wt. Kg/Mtr.
1	18011	108.00	53.00	1.80	1.884

DOOR FRAME

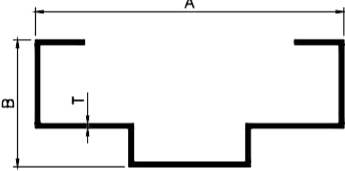

Sr.No.	Section No.	A	B	T	Wt. Kg/Mtr.
1	ARI 17129	112.00	46.00	1.60	1.008

DOOR FRAME

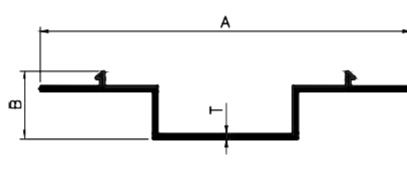

Sr.No.	Section No.	A	B	T	Wt. Kg/Mtr.
1	17213	112.00	20.50	1.60	0.650

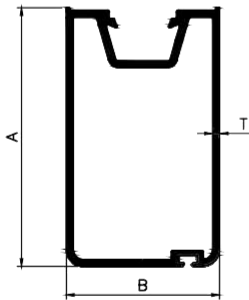

Sr.No.	Section No.	A	B	T	Wt. Kg/Mtr.
1	18041	75.00	44.39	2.00	1.420
	*				

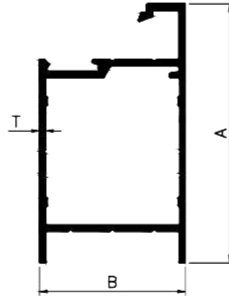

Sr.No.	Section No.	A	B	T	Wt. Kg/Mtr.
1	18042	75.00	42.28	1.76	1.147
	*				

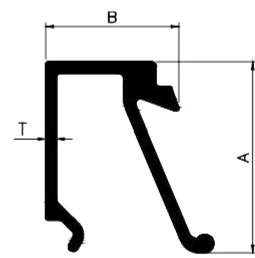

Sr.No.	Section No.	A	B	T	Wt. Kg/Mtr.
1	17967	19.45	13.59	1.11	0.190
	*				

20 MM SLIDING SERIES

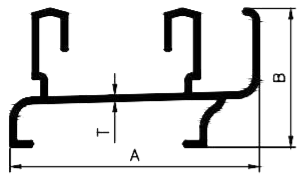

Sr.No.	Section No.	A	B	T	Wt. Kg/Mtr.
1	ART 12215	56.53	31.50	1.40	0.648

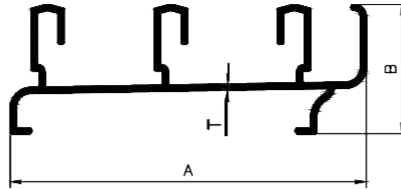

Sr.No.	Section No.	A	B	T	Wt. Kg/Mtr.
1	ART 12361	86.53	31.50	1.40	0.890

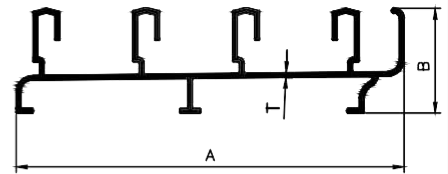

Sr.No.	Section No.	A	B	T	Wt. Kg/Mtr.
1	ART 12455	116.53	31.50	1.40	1.190

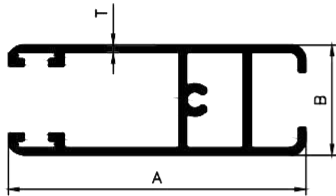

Sr.No.	Section No.	A	B	T	Wt. Kg/Mtr.
1	ART 12694	54.00	20.00	1.40	0.639

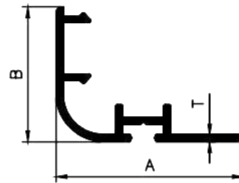

Sr.No.	Section No.	A	B	T	Wt. Kg/Mtr.
1	ART 17916	34.00	24.50	1.20	0.248

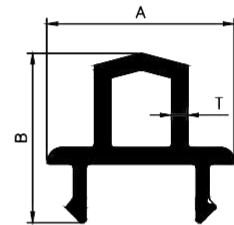

Sr.No.	Section No.	A	B	T	Wt. Kg/Mtr.
1	ART 17917	16.00	14.50	1.40	0.165

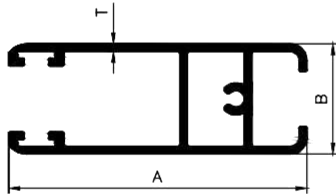

Sr.No.	Section No.	A	B	T	Wt. Kg/Mtr.
1	ART 12702/B	54.00	20.00	1.40	0.636

23MM SLIDING SERIES

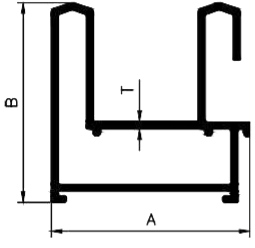
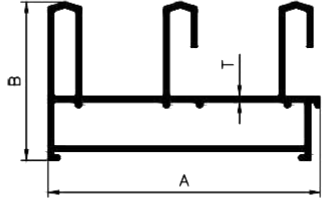
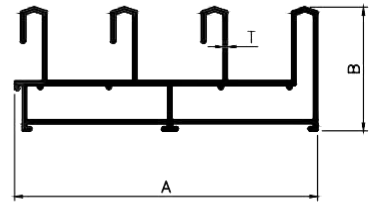
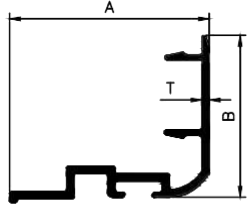
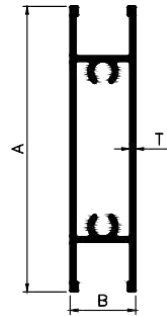
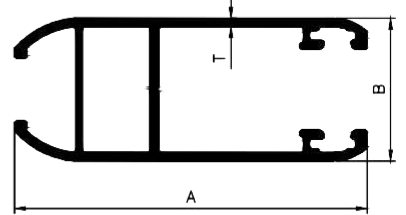
																																						
<table border="1"> <thead> <tr> <th>Sr.No.</th> <th>Section No.</th> <th>A</th> <th>B</th> <th>T</th> <th>Wt. Kg/Mtr.</th> </tr> </thead> <tbody> <tr> <td>1</td> <td>ART 12502</td> <td>40.00</td> <td>40.00</td> <td>1.40</td> <td>0.713</td> </tr> </tbody> </table>	Sr.No.	Section No.	A	B	T	Wt. Kg/Mtr.	1	ART 12502	40.00	40.00	1.40	0.713	<table border="1"> <thead> <tr> <th>Sr.No.</th> <th>Section No.</th> <th>A</th> <th>B</th> <th>T</th> <th>Wt. Kg/Mtr.</th> </tr> </thead> <tbody> <tr> <td>1</td> <td>ART 12538</td> <td>69.50</td> <td>40.00</td> <td>1.40</td> <td>1.098</td> </tr> </tbody> </table>	Sr.No.	Section No.	A	B	T	Wt. Kg/Mtr.	1	ART 12538	69.50	40.00	1.40	1.098	<table border="1"> <thead> <tr> <th>Sr.No.</th> <th>Section No.</th> <th>A</th> <th>B</th> <th>T</th> <th>Wt. Kg/Mtr.</th> </tr> </thead> <tbody> <tr> <td>1</td> <td>ART 12541</td> <td>99.00</td> <td>40.00</td> <td>1.40</td> <td>1.495</td> </tr> </tbody> </table>	Sr.No.	Section No.	A	B	T	Wt. Kg/Mtr.	1	ART 12541	99.00	40.00	1.40	1.495
Sr.No.	Section No.	A	B	T	Wt. Kg/Mtr.																																	
1	ART 12502	40.00	40.00	1.40	0.713																																	
Sr.No.	Section No.	A	B	T	Wt. Kg/Mtr.																																	
1	ART 12538	69.50	40.00	1.40	1.098																																	
Sr.No.	Section No.	A	B	T	Wt. Kg/Mtr.																																	
1	ART 12541	99.00	40.00	1.40	1.495																																	
																																						
<table border="1"> <thead> <tr> <th>Sr.No.</th> <th>Section No.</th> <th>A</th> <th>B</th> <th>T</th> <th>Wt. Kg/Mtr.</th> </tr> </thead> <tbody> <tr> <td>1</td> <td>ARI 17035</td> <td>32.60</td> <td>26.20</td> <td>1.20</td> <td>0.248</td> </tr> </tbody> </table>	Sr.No.	Section No.	A	B	T	Wt. Kg/Mtr.	1	ARI 17035	32.60	26.20	1.20	0.248	<table border="1"> <thead> <tr> <th>Sr.No.</th> <th>Section No.</th> <th>A</th> <th>B</th> <th>T</th> <th>Wt. Kg/Mtr.</th> </tr> </thead> <tbody> <tr> <td>1</td> <td>12703</td> <td>57.60</td> <td>13.30</td> <td>1.20</td> <td>0.501</td> </tr> </tbody> </table>	Sr.No.	Section No.	A	B	T	Wt. Kg/Mtr.	1	12703	57.60	13.30	1.20	0.501	<table border="1"> <thead> <tr> <th>Sr.No.</th> <th>Section No.</th> <th>A</th> <th>B</th> <th>T</th> <th>Wt. Kg/Mtr.</th> </tr> </thead> <tbody> <tr> <td>1</td> <td>ARI 12660</td> <td>57.60</td> <td>23.00</td> <td>1.40</td> <td>0.668</td> </tr> </tbody> </table>	Sr.No.	Section No.	A	B	T	Wt. Kg/Mtr.	1	ARI 12660	57.60	23.00	1.40	0.668
Sr.No.	Section No.	A	B	T	Wt. Kg/Mtr.																																	
1	ARI 17035	32.60	26.20	1.20	0.248																																	
Sr.No.	Section No.	A	B	T	Wt. Kg/Mtr.																																	
1	12703	57.60	13.30	1.20	0.501																																	
Sr.No.	Section No.	A	B	T	Wt. Kg/Mtr.																																	
1	ARI 12660	57.60	23.00	1.40	0.668																																	

26MM SLIDING SERIES

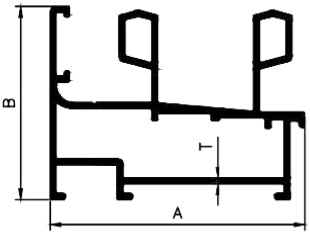
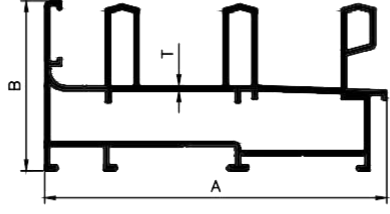
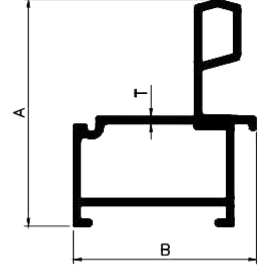
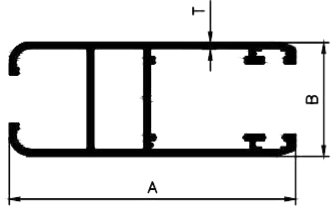
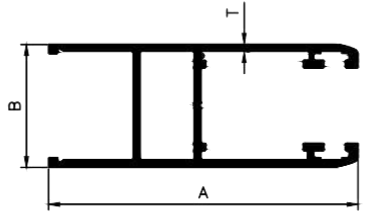
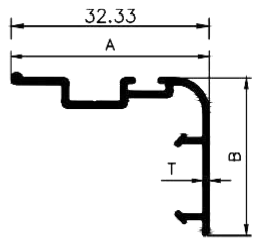
																																												
<table border="1"> <thead> <tr> <th>Sr.No.</th> <th>Section No.</th> <th>A</th> <th>B</th> <th>T</th> <th>Wt. Kg/Mtr.</th> </tr> </thead> <tbody> <tr> <td>1</td> <td>ART 12191</td> <td>66.50</td> <td>50.00</td> <td>1.50</td> <td>1.336</td> </tr> </tbody> </table>	Sr.No.	Section No.	A	B	T	Wt. Kg/Mtr.	1	ART 12191	66.50	50.00	1.50	1.336	<table border="1"> <thead> <tr> <th>Sr.No.</th> <th>Section No.</th> <th>A</th> <th>B</th> <th>T</th> <th>Wt. Kg/Mtr.</th> </tr> </thead> <tbody> <tr> <td>1</td> <td>ART 12529</td> <td>101.50</td> <td>50.00</td> <td>1.35</td> <td>1.750</td> </tr> <tr> <td>2</td> <td>ART 12192</td> <td>101.50</td> <td>50.00</td> <td>1.50</td> <td>1.921</td> </tr> </tbody> </table>	Sr.No.	Section No.	A	B	T	Wt. Kg/Mtr.	1	ART 12529	101.50	50.00	1.35	1.750	2	ART 12192	101.50	50.00	1.50	1.921	<table border="1"> <thead> <tr> <th>Sr.No.</th> <th>Section No.</th> <th>A</th> <th>B</th> <th>T</th> <th>Wt. Kg/Mtr.</th> </tr> </thead> <tbody> <tr> <td>1</td> <td>ART 12544</td> <td>49.00</td> <td>39.70</td> <td>1.50</td> <td>0.736</td> </tr> </tbody> </table>	Sr.No.	Section No.	A	B	T	Wt. Kg/Mtr.	1	ART 12544	49.00	39.70	1.50	0.736
Sr.No.	Section No.	A	B	T	Wt. Kg/Mtr.																																							
1	ART 12191	66.50	50.00	1.50	1.336																																							
Sr.No.	Section No.	A	B	T	Wt. Kg/Mtr.																																							
1	ART 12529	101.50	50.00	1.35	1.750																																							
2	ART 12192	101.50	50.00	1.50	1.921																																							
Sr.No.	Section No.	A	B	T	Wt. Kg/Mtr.																																							
1	ART 12544	49.00	39.70	1.50	0.736																																							
																																												
<table border="1"> <thead> <tr> <th>Sr.No.</th> <th>Section No.</th> <th>A</th> <th>B</th> <th>T</th> <th>Wt. Kg/Mtr.</th> </tr> </thead> <tbody> <tr> <td>1</td> <td>ART 12188</td> <td>66.00</td> <td>26.00</td> <td>1.50</td> <td>0.851</td> </tr> </tbody> </table>	Sr.No.	Section No.	A	B	T	Wt. Kg/Mtr.	1	ART 12188	66.00	26.00	1.50	0.851	<table border="1"> <thead> <tr> <th>Sr.No.</th> <th>Section No.</th> <th>A</th> <th>B</th> <th>T</th> <th>Wt. Kg/Mtr.</th> </tr> </thead> <tbody> <tr> <td>1</td> <td>ART 12190</td> <td>66.00</td> <td>26.00</td> <td>1.50</td> <td>0.815</td> </tr> </tbody> </table>	Sr.No.	Section No.	A	B	T	Wt. Kg/Mtr.	1	ART 12190	66.00	26.00	1.50	0.815	<table border="1"> <thead> <tr> <th>Sr.No.</th> <th>Section No.</th> <th>A</th> <th>B</th> <th>T</th> <th>Wt. Kg/Mtr.</th> </tr> </thead> <tbody> <tr> <td>1</td> <td>ART 12189</td> <td>38.00</td> <td>30.00</td> <td>1.20</td> <td>0.286</td> </tr> </tbody> </table>	Sr.No.	Section No.	A	B	T	Wt. Kg/Mtr.	1	ART 12189	38.00	30.00	1.20	0.286						
Sr.No.	Section No.	A	B	T	Wt. Kg/Mtr.																																							
1	ART 12188	66.00	26.00	1.50	0.851																																							
Sr.No.	Section No.	A	B	T	Wt. Kg/Mtr.																																							
1	ART 12190	66.00	26.00	1.50	0.815																																							
Sr.No.	Section No.	A	B	T	Wt. Kg/Mtr.																																							
1	ART 12189	38.00	30.00	1.20	0.286																																							

ALL DIMENSIONS ARE IN MM.

WEIGHT TOLERANCES ± 7 TO 10%

MAY-2020

PAGE 15

27MM SLIDING SERIES

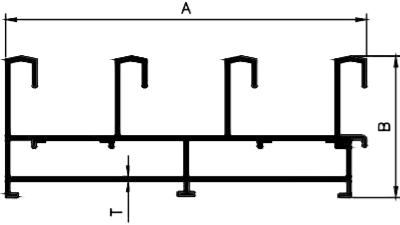
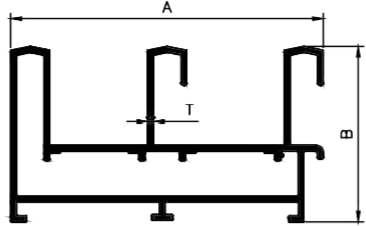
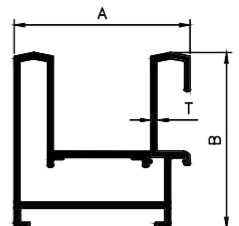
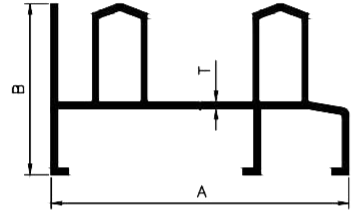
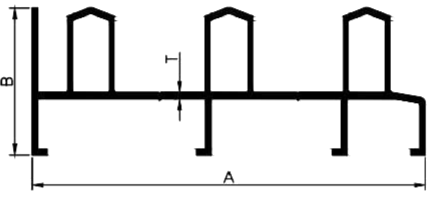
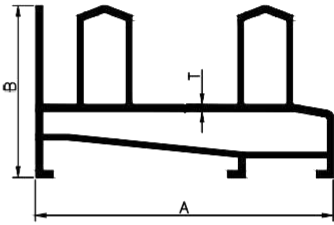
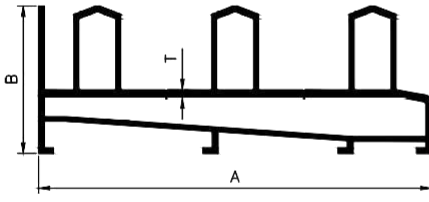
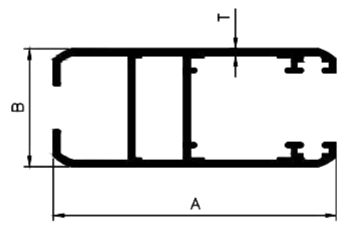
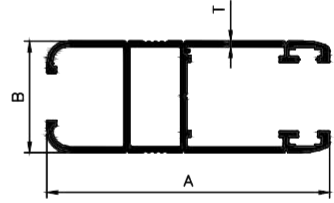
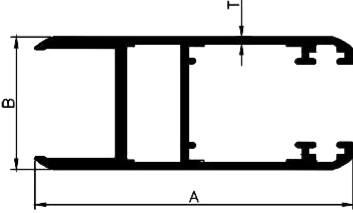
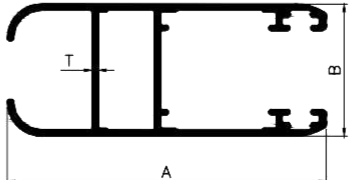
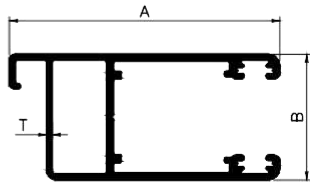
																																																		
<table border="1"> <thead> <tr> <th>Sr.No.</th> <th>Section No.</th> <th>A</th> <th>B</th> <th>T</th> <th>Wt. Kg/Mtr.</th> </tr> </thead> <tbody> <tr> <td>1</td> <td>ARI 12536</td> <td>115.00</td> <td>45.00</td> <td>1.40</td> <td>1.765</td> </tr> </tbody> </table>	Sr.No.	Section No.	A	B	T	Wt. Kg/Mtr.	1	ARI 12536	115.00	45.00	1.40	1.765	<table border="1"> <thead> <tr> <th>Sr.No.</th> <th>Section No.</th> <th>A</th> <th>B</th> <th>T</th> <th>Wt. Kg/Mtr.</th> </tr> </thead> <tbody> <tr> <td>1</td> <td>ART 12923</td> <td>80.00</td> <td>45.00</td> <td>1.40</td> <td>1.320</td> </tr> <tr> <td>2</td> <td>ART 12136</td> <td>80.00</td> <td>45.00</td> <td>1.50</td> <td>1.412</td> </tr> </tbody> </table>	Sr.No.	Section No.	A	B	T	Wt. Kg/Mtr.	1	ART 12923	80.00	45.00	1.40	1.320	2	ART 12136	80.00	45.00	1.50	1.412	<table border="1"> <thead> <tr> <th>Sr.No.</th> <th>Section No.</th> <th>A</th> <th>B</th> <th>T</th> <th>Wt. Kg/Mtr.</th> </tr> </thead> <tbody> <tr> <td>1</td> <td>ART 12924</td> <td>45.00</td> <td>45.00</td> <td>1.40</td> <td>0.839</td> </tr> <tr> <td>2</td> <td>ART 12137</td> <td>45.00</td> <td>45.00</td> <td>1.50</td> <td>0.900</td> </tr> </tbody> </table>	Sr.No.	Section No.	A	B	T	Wt. Kg/Mtr.	1	ART 12924	45.00	45.00	1.40	0.839	2	ART 12137	45.00	45.00	1.50	0.900
Sr.No.	Section No.	A	B	T	Wt. Kg/Mtr.																																													
1	ARI 12536	115.00	45.00	1.40	1.765																																													
Sr.No.	Section No.	A	B	T	Wt. Kg/Mtr.																																													
1	ART 12923	80.00	45.00	1.40	1.320																																													
2	ART 12136	80.00	45.00	1.50	1.412																																													
Sr.No.	Section No.	A	B	T	Wt. Kg/Mtr.																																													
1	ART 12924	45.00	45.00	1.40	0.839																																													
2	ART 12137	45.00	45.00	1.50	0.900																																													
																																																		
<table border="1"> <thead> <tr> <th>Sr.No.</th> <th>Section No.</th> <th>A</th> <th>B</th> <th>T</th> <th>Wt. Kg/Mtr.</th> </tr> </thead> <tbody> <tr> <td>1</td> <td>ART 12525</td> <td>69.48</td> <td>40.00</td> <td>1.50</td> <td>0.946</td> </tr> </tbody> </table>	Sr.No.	Section No.	A	B	T	Wt. Kg/Mtr.	1	ART 12525	69.48	40.00	1.50	0.946	<table border="1"> <thead> <tr> <th>Sr.No.</th> <th>Section No.</th> <th>A</th> <th>B</th> <th>T</th> <th>Wt. Kg/Mtr.</th> </tr> </thead> <tbody> <tr> <td>1</td> <td>ART 12527</td> <td>106.96</td> <td>40.00</td> <td>1.80</td> <td>1.425</td> </tr> </tbody> </table>	Sr.No.	Section No.	A	B	T	Wt. Kg/Mtr.	1	ART 12527	106.96	40.00	1.80	1.425	<table border="1"> <thead> <tr> <th>Sr.No.</th> <th>Section No.</th> <th>A</th> <th>B</th> <th>T</th> <th>Wt. Kg/Mtr.</th> </tr> </thead> <tbody> <tr> <td>1</td> <td>ART 12526</td> <td>69.48</td> <td>40.00</td> <td>1.50</td> <td>1.118</td> </tr> </tbody> </table>	Sr.No.	Section No.	A	B	T	Wt. Kg/Mtr.	1	ART 12526	69.48	40.00	1.50	1.118												
Sr.No.	Section No.	A	B	T	Wt. Kg/Mtr.																																													
1	ART 12525	69.48	40.00	1.50	0.946																																													
Sr.No.	Section No.	A	B	T	Wt. Kg/Mtr.																																													
1	ART 12527	106.96	40.00	1.80	1.425																																													
Sr.No.	Section No.	A	B	T	Wt. Kg/Mtr.																																													
1	ART 12526	69.48	40.00	1.50	1.118																																													
																																																		
<table border="1"> <thead> <tr> <th>Sr.No.</th> <th>Section No.</th> <th>A</th> <th>B</th> <th>T</th> <th>Wt. Kg/Mtr.</th> </tr> </thead> <tbody> <tr> <td>1</td> <td>ART 12528</td> <td>106.96</td> <td>40.00</td> <td>1.80</td> <td>1.678</td> </tr> </tbody> </table>	Sr.No.	Section No.	A	B	T	Wt. Kg/Mtr.	1	ART 12528	106.96	40.00	1.80	1.678	<table border="1"> <thead> <tr> <th>Sr.No.</th> <th>Section No.</th> <th>A</th> <th>B</th> <th>T</th> <th>Wt. Kg/Mtr.</th> </tr> </thead> <tbody> <tr> <td>1</td> <td>ART 12925</td> <td>65.00</td> <td>27.00</td> <td>1.40</td> <td>0.833</td> </tr> <tr> <td>1</td> <td>ARI 12139</td> <td>65.00</td> <td>27.00</td> <td>1.50</td> <td>0.878</td> </tr> </tbody> </table>	Sr.No.	Section No.	A	B	T	Wt. Kg/Mtr.	1	ART 12925	65.00	27.00	1.40	0.833	1	ARI 12139	65.00	27.00	1.50	0.878	<table border="1"> <thead> <tr> <th>Sr.No.</th> <th>Section No.</th> <th>A</th> <th>B</th> <th>T</th> <th>Wt. Kg/Mtr.</th> </tr> </thead> <tbody> <tr> <td>1</td> <td>ART 12677</td> <td>66.00</td> <td>26.00</td> <td>1.30</td> <td>0.764</td> </tr> </tbody> </table>	Sr.No.	Section No.	A	B	T	Wt. Kg/Mtr.	1	ART 12677	66.00	26.00	1.30	0.764						
Sr.No.	Section No.	A	B	T	Wt. Kg/Mtr.																																													
1	ART 12528	106.96	40.00	1.80	1.678																																													
Sr.No.	Section No.	A	B	T	Wt. Kg/Mtr.																																													
1	ART 12925	65.00	27.00	1.40	0.833																																													
1	ARI 12139	65.00	27.00	1.50	0.878																																													
Sr.No.	Section No.	A	B	T	Wt. Kg/Mtr.																																													
1	ART 12677	66.00	26.00	1.30	0.764																																													
																																																		
<table border="1"> <thead> <tr> <th>Sr.No.</th> <th>Section No.</th> <th>A</th> <th>B</th> <th>T</th> <th>Wt. Kg/Mtr.</th> </tr> </thead> <tbody> <tr> <td>1</td> <td>ARI 12683</td> <td>65.00</td> <td>27.00</td> <td>1.40</td> <td>0.904</td> </tr> </tbody> </table>	Sr.No.	Section No.	A	B	T	Wt. Kg/Mtr.	1	ARI 12683	65.00	27.00	1.40	0.904	<table border="1"> <thead> <tr> <th>Sr.No.</th> <th>Section No.</th> <th>A</th> <th>B</th> <th>T</th> <th>Wt. Kg/Mtr.</th> </tr> </thead> <tbody> <tr> <td>1</td> <td>ART 12750</td> <td>65.00</td> <td>27.00</td> <td>1.25</td> <td>0.732</td> </tr> </tbody> </table>	Sr.No.	Section No.	A	B	T	Wt. Kg/Mtr.	1	ART 12750	65.00	27.00	1.25	0.732	<table border="1"> <thead> <tr> <th>Sr.No.</th> <th>Section No.</th> <th>A</th> <th>B</th> <th>T</th> <th>Wt. Kg/Mtr.</th> </tr> </thead> <tbody> <tr> <td>1</td> <td>12751</td> <td>54.90</td> <td>25.52</td> <td>1.40</td> <td>0.633</td> </tr> </tbody> </table>	Sr.No.	Section No.	A	B	T	Wt. Kg/Mtr.	1	12751	54.90	25.52	1.40	0.633												
Sr.No.	Section No.	A	B	T	Wt. Kg/Mtr.																																													
1	ARI 12683	65.00	27.00	1.40	0.904																																													
Sr.No.	Section No.	A	B	T	Wt. Kg/Mtr.																																													
1	ART 12750	65.00	27.00	1.25	0.732																																													
Sr.No.	Section No.	A	B	T	Wt. Kg/Mtr.																																													
1	12751	54.90	25.52	1.40	0.633																																													

27MM SLIDING SERIES

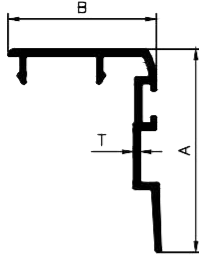

Sr.No.	Section No.	A	B	T	Wt. Kg/Mtr.
1	ART 12138	39.00	28.40	1.30	0.301

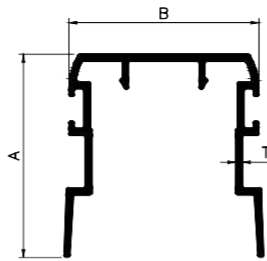

Sr.No.	Section No.	A	B	T	Wt. Kg/Mtr.
1	ART 17965	39.00	36.40	1.30	0.496

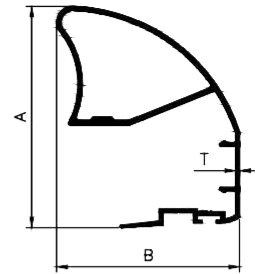

Sr.No.	Section No.	A	B	T	Wt. Kg/Mtr.
1	ART 17034	72.43	59.52	1.25	0.920

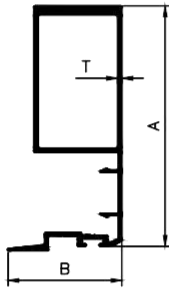

Sr.No.	Section No.	A	B	T	Wt. Kg/Mtr.
1	17943	81.75	38.75	1.50	0.332

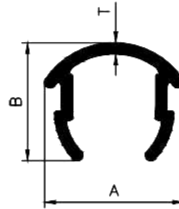

Sr.No.	Section No.	A	B	T	Wt. Kg/Mtr.
1	ART 17915	12.60	10.70	1.00	0.083

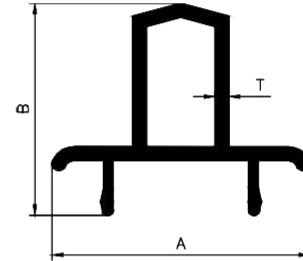

Sr.No.	Section No.	A	B	T	Wt. Kg/Mtr.
1	ART 17047	26.30	21.60	1.40	0.263

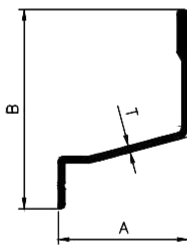

Sr.No.	Section No.	A	B	T	Wt. Kg/Mtr.
1	ART 17061	24.00	37.00	1.20	0.195

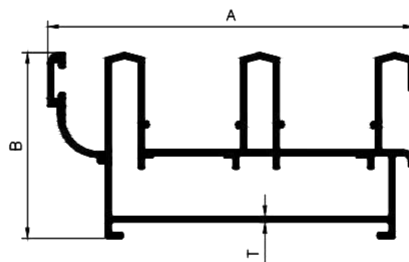

Sr.No.	Section No.	A	B	T	Wt. Kg/Mtr.
1	ARI 12961	95.00	48.00	1.50	1.678

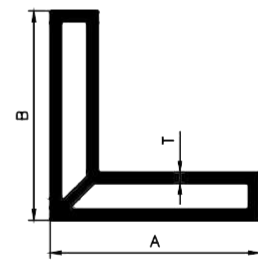

Sr.No.	Section No.	A	B	T	Wt. Kg/Mtr.
1	ART 17048	38.00	38.00	2.00	0.814

27MM SLIDING SERIES 2

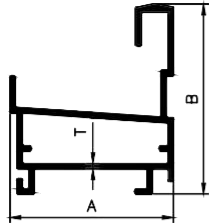

Sr.No.	Section No.	A	B	T	Wt. Kg/Mtr.
1	ART 12193	38.70	45.00	1.20	0.580

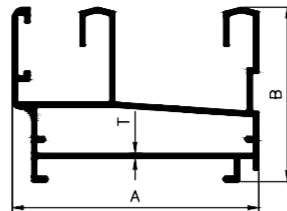

Sr.No.	Section No.	A	B	T	Wt. Kg/Mtr.
1	ART 12194	63.50	45.00	1.30	1.006

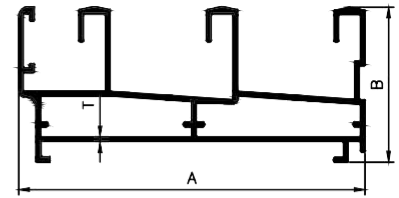

Sr.No.	Section No.	A	B	T	Wt. Kg/Mtr.
1	ART 12195	100.50	45.00	1.30	1.493

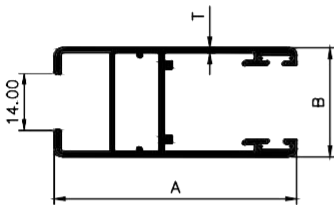

Sr.No.	Section No.	A	B	T	Wt. Kg/Mtr.
1	ARI 12673	60.00	27.00	1.30	0.742

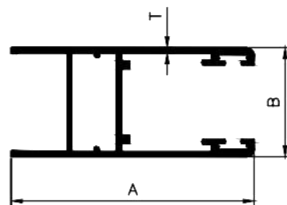

Sr.No.	Section No.	A	B	T	Wt. Kg/Mtr.
1	ART 12674	60.00	27.00	1.30	0.706

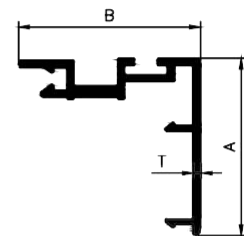

Sr.No.	Section No.	A	B	T	Wt. Kg/Mtr.
1	ART 17084	32.20	33.00	1.40	0.351

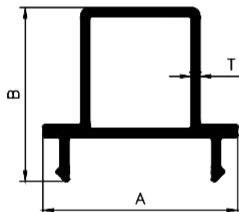

Sr.No.	Section No.	A	B	T	Wt. Kg/Mtr.
1	ARI 17904	22.10	19.70	1.00	0.200

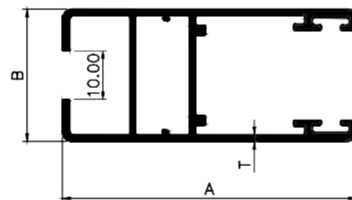

Sr.No.	Section No.	A	B	T	Wt. Kg/Mtr.
1	12704	60.00	27.00	1.30	0.758

SLEEK 27MM SLIDING SERIES

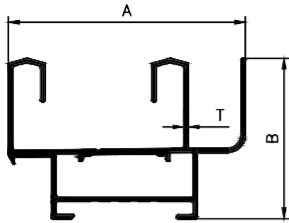

Sr.No.	Section No.	A	B	T	Wt. Kg/Mtr.
1	ART 12516	65.05	44.10	1.20	0.880

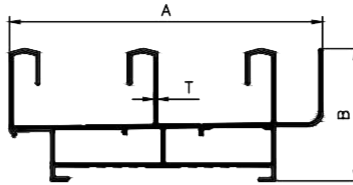

Sr.No.	Section No.	A	B	T	Wt. Kg/Mtr.
1	ART 12517	104.40	44.10	1.20	1.305

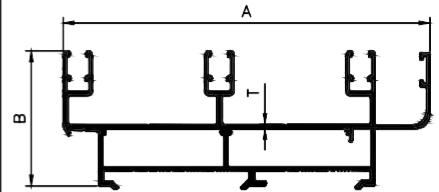

Sr.No.	Section No.	A	B	T	Wt. Kg/Mtr.
1	ART 12518	126.10	46.40	1.50	1.915

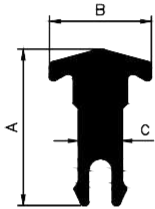

Sr.No.	Section No.	A	B	C	Wt. Kg/Mtr.
1	ART 17067	15.60	10.20	4.40	0.190

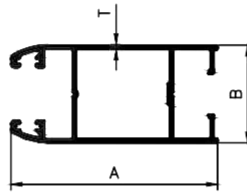

Sr.No.	Section No.	A	B	T	Wt. Kg/Mtr.
1	ART 12670	61.30	29.00	1.24	0.735

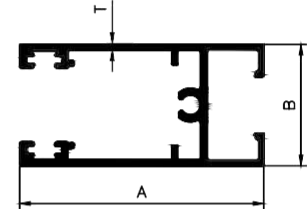

Sr.No.	Section No.	A	B	T	Wt. Kg/Mtr.
1	ART 12671	51.80	25.76	1.30	0.640

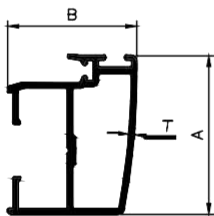

Sr.No.	Section No.	A	B	T	Wt. Kg/Mtr.
1	ART 17068	35.94	29.25	1.20	0.500

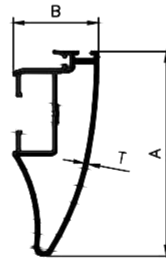

Sr.No.	Section No.	A	B	T	Wt. Kg/Mtr.
1	ART 17069	70.40	29.25	1.30	0.750

Corporate Office:-
 Survey No. - 1383/D/Paiki 1 Village - Rajpur, Taluka -
 Kadi, Dist - Mehsana Pin code : 382715 Phone: (0)02764-
 278388/89 E-mail: info@apurviind.com web:
 www.apurviind.com

35 MM SLIDING SERIES

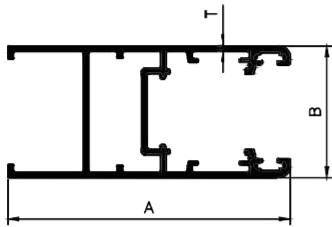

Sr.No.	Section No.	A	B	T	Wt. Kg/Mtr.
1	ART 12942	75.00	35.00	1.50	1.123

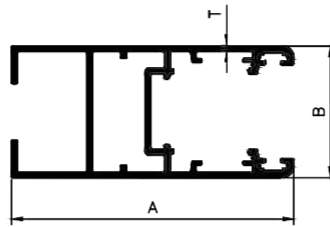

Sr.No.	Section No.	A	B	T	Wt. Kg/Mtr.
1	ART 12943	75.00	35.00	1.50	1.172

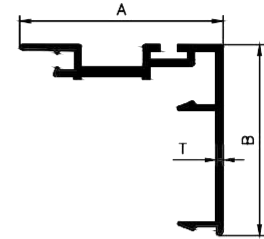

Sr.No.	Section No.	A	B	T	Wt. Kg/Mtr.
1	ART 12944	41.50	39.00	1.50	0.449

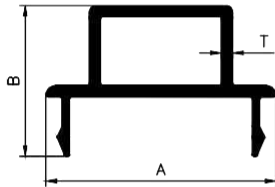

Sr.No.	Section No.	A	B	T	Wt. Kg/Mtr.
1	ARI 17905	28.90	19.00	1.40	0.280

37 MM SLIDING SERIES

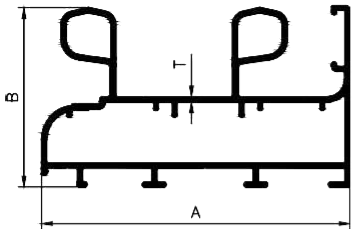

Sr.No.	Section No.	A	B	T	Wt. Kg/Mtr.
1	ART 12535	90.00	52.30	1.50	1.730

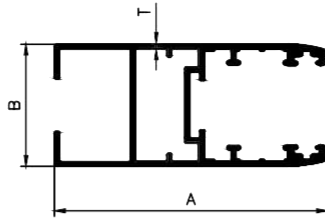

Sr.No.	Section No.	A	B	T	Wt. Kg/Mtr.
1	ART 12672	82.70	37.00	1.50	1.335

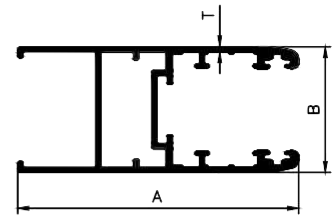

Sr.No.	Section No.	A	B	T	Wt. Kg/Mtr.
1	ART 12689	82.70	37.00	1.50	1.274

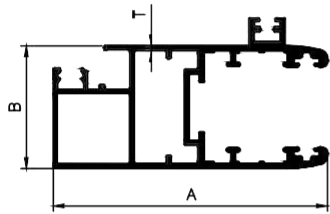

Sr.No.	Section No.	A	B	T	Wt. Kg/Mtr.
1	ART 12676	82.70	37.01	1.50	1.518

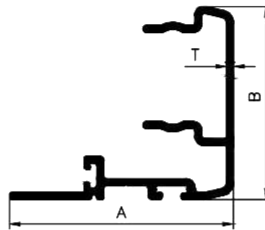

Sr.No.	Section No.	A	B	T	Wt. Kg/Mtr.
1	ART 17070	52.20	44.90	1.60	0.689

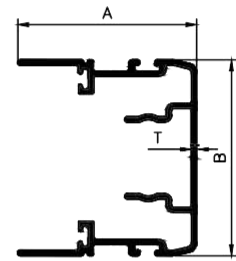

Sr.No.	Section No.	A	B	T	Wt. Kg/Mtr.
1	ART 17088	52.21	57.10	1.60	1.055

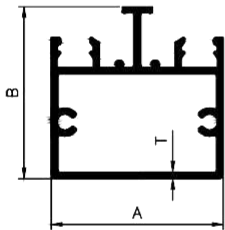

Sr.No.	Section No.	A	B	T	Wt. Kg/Mtr.
1	ART 17089	37.00	37.01	1.40	0.673

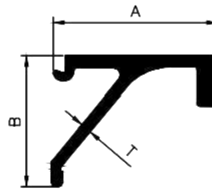

Sr.No.	Section No.	A	B	T	Wt. Kg/Mtr.
1	ART 17090	16.20	12.91	1.08	0.117

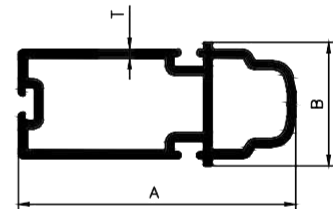

Sr.No.	Section No.	A	B	T	Wt. Kg/Mtr.
1	ART 17072	51.50	23.00	1.60	0.720

CASEMENT SERIES 29MM

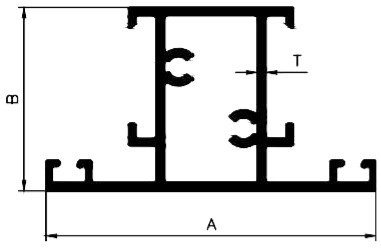
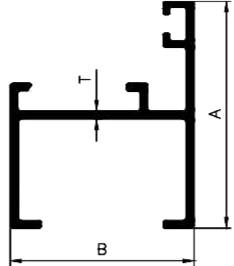
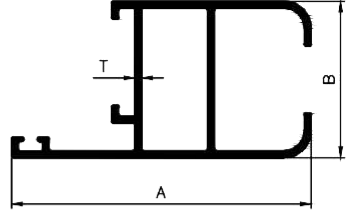
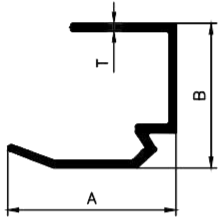
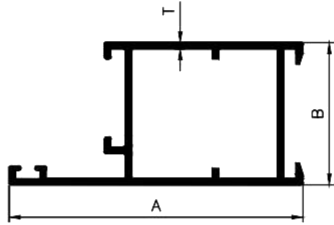
																																						
<table border="1"> <thead> <tr> <th>Sr.No.</th> <th>Section No.</th> <th>A</th> <th>B</th> <th>T</th> <th>Wt. Kg/Mtr.</th> </tr> </thead> <tbody> <tr> <td>1</td> <td>ART 19005</td> <td>53.80</td> <td>30.00</td> <td>1.40</td> <td>0.684</td> </tr> </tbody> </table>	Sr.No.	Section No.	A	B	T	Wt. Kg/Mtr.	1	ART 19005	53.80	30.00	1.40	0.684	<table border="1"> <thead> <tr> <th>Sr.No.</th> <th>Section No.</th> <th>A</th> <th>B</th> <th>T</th> <th>Wt. Kg/Mtr.</th> </tr> </thead> <tbody> <tr> <td>1</td> <td>ART 19003</td> <td>37.00</td> <td>30.00</td> <td>1.30</td> <td>0.386</td> </tr> </tbody> </table>	Sr.No.	Section No.	A	B	T	Wt. Kg/Mtr.	1	ART 19003	37.00	30.00	1.30	0.386	<table border="1"> <thead> <tr> <th>Sr.No.</th> <th>Section No.</th> <th>A</th> <th>B</th> <th>T</th> <th>Wt. Kg/Mtr.</th> </tr> </thead> <tbody> <tr> <td>1</td> <td>ART 12658</td> <td>55.50</td> <td>29.00</td> <td>1.30</td> <td>0.594</td> </tr> </tbody> </table>	Sr.No.	Section No.	A	B	T	Wt. Kg/Mtr.	1	ART 12658	55.50	29.00	1.30	0.594
Sr.No.	Section No.	A	B	T	Wt. Kg/Mtr.																																	
1	ART 19005	53.80	30.00	1.40	0.684																																	
Sr.No.	Section No.	A	B	T	Wt. Kg/Mtr.																																	
1	ART 19003	37.00	30.00	1.30	0.386																																	
Sr.No.	Section No.	A	B	T	Wt. Kg/Mtr.																																	
1	ART 12658	55.50	29.00	1.30	0.594																																	
																																						
<table border="1"> <thead> <tr> <th>Sr.No.</th> <th>Section No.</th> <th>A</th> <th>B</th> <th>T</th> <th>Wt. Kg/Mtr.</th> </tr> </thead> <tbody> <tr> <td>1</td> <td>ART 19004</td> <td>20.80</td> <td>17.90</td> <td>1.00</td> <td>0.136</td> </tr> </tbody> </table>	Sr.No.	Section No.	A	B	T	Wt. Kg/Mtr.	1	ART 19004	20.80	17.90	1.00	0.136	<table border="1"> <thead> <tr> <th>Sr.No.</th> <th>Section No.</th> <th>A</th> <th>B</th> <th>T</th> <th>Wt. Kg/Mtr.</th> </tr> </thead> <tbody> <tr> <td>1</td> <td>ART 12663</td> <td>60.00</td> <td>29.00</td> <td>1.30</td> <td>0.620</td> </tr> </tbody> </table>	Sr.No.	Section No.	A	B	T	Wt. Kg/Mtr.	1	ART 12663	60.00	29.00	1.30	0.620													
Sr.No.	Section No.	A	B	T	Wt. Kg/Mtr.																																	
1	ART 19004	20.80	17.90	1.00	0.136																																	
Sr.No.	Section No.	A	B	T	Wt. Kg/Mtr.																																	
1	ART 12663	60.00	29.00	1.30	0.620																																	

CASEMENT SERIES 38MM

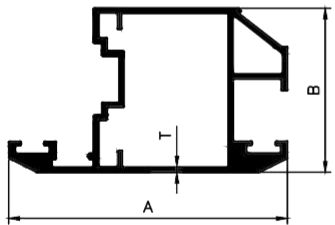
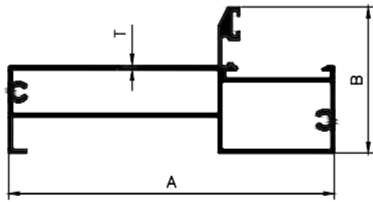
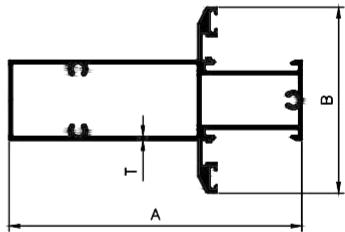
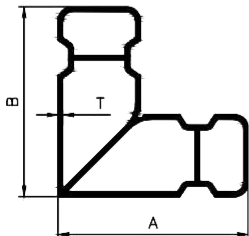
																																						
<table border="1"> <thead> <tr> <th>Sr.No.</th> <th>Section No.</th> <th>A</th> <th>B</th> <th>T</th> <th>Wt. Kg/Mtr.</th> </tr> </thead> <tbody> <tr> <td>1</td> <td>ART 17058</td> <td>65.00</td> <td>38.30</td> <td>1.20</td> <td>0.956</td> </tr> </tbody> </table>	Sr.No.	Section No.	A	B	T	Wt. Kg/Mtr.	1	ART 17058	65.00	38.30	1.20	0.956	<table border="1"> <thead> <tr> <th>Sr.No.</th> <th>Section No.</th> <th>A</th> <th>B</th> <th>T</th> <th>Wt. Kg/Mtr.</th> </tr> </thead> <tbody> <tr> <td>1</td> <td>ART 17059</td> <td>108.50</td> <td>48.70</td> <td>1.25</td> <td>1.298</td> </tr> </tbody> </table>	Sr.No.	Section No.	A	B	T	Wt. Kg/Mtr.	1	ART 17059	108.50	48.70	1.25	1.298	<table border="1"> <thead> <tr> <th>Sr.No.</th> <th>Section No.</th> <th>A</th> <th>B</th> <th>T</th> <th>Wt. Kg/Mtr.</th> </tr> </thead> <tbody> <tr> <td>1</td> <td>ART 17060</td> <td>108.50</td> <td>68.90</td> <td>1.25</td> <td>1.522</td> </tr> </tbody> </table>	Sr.No.	Section No.	A	B	T	Wt. Kg/Mtr.	1	ART 17060	108.50	68.90	1.25	1.522
Sr.No.	Section No.	A	B	T	Wt. Kg/Mtr.																																	
1	ART 17058	65.00	38.30	1.20	0.956																																	
Sr.No.	Section No.	A	B	T	Wt. Kg/Mtr.																																	
1	ART 17059	108.50	48.70	1.25	1.298																																	
Sr.No.	Section No.	A	B	T	Wt. Kg/Mtr.																																	
1	ART 17060	108.50	68.90	1.25	1.522																																	
																																						
<table border="1"> <thead> <tr> <th>Sr.No.</th> <th>Section No.</th> <th>A</th> <th>B</th> <th>T</th> <th>Wt. Kg/Mtr.</th> </tr> </thead> <tbody> <tr> <td>1</td> <td>ART 17056</td> <td>54.00</td> <td>54.00</td> <td>1.30</td> <td>0.968</td> </tr> </tbody> </table>	Sr.No.	Section No.	A	B	T	Wt. Kg/Mtr.	1	ART 17056	54.00	54.00	1.30	0.968																										
Sr.No.	Section No.	A	B	T	Wt. Kg/Mtr.																																	
1	ART 17056	54.00	54.00	1.30	0.968																																	

CASEMENT SERIES 40MM

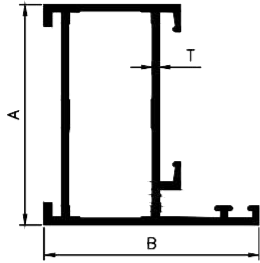

Sr.No.	Section No.	A	B	T	Wt. Kg/Mtr.
1	ART 19001	40.00	39.00	1.20	0.547

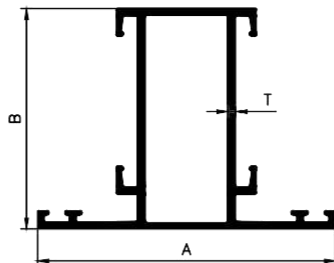

Sr.No.	Section No.	A	B	T	Wt. Kg/Mtr.
1	ART 19007	54.00	40.00	1.40	0.657

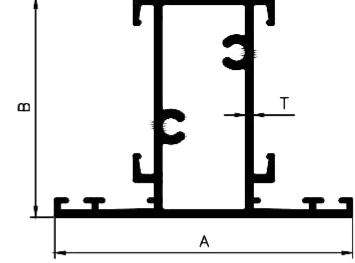

Sr.No.	Section No.	A	B	T	Wt. Kg/Mtr.
1	ART 19006	54.00	39.90	1.30	0.715

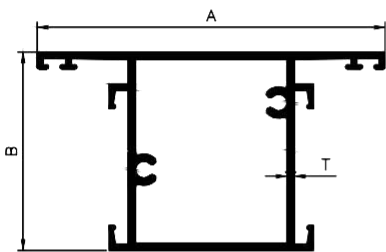

Sr.No.	Section No.	A	B	T	Wt. Kg/Mtr.
1	ARI 19008	70.10	40.00	1.50	0.905

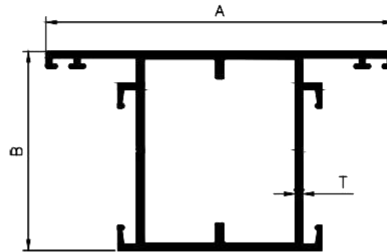

Sr.No.	Section No.	A	B	T	Wt. Kg/Mtr.
1	ARI 19013	70.10	40.00	1.50	0.867

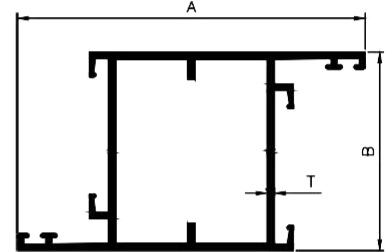

Sr.No.	Section No.	A	B	T	Wt. Kg/Mtr.
1	ART 19021	70.10	40.00	1.50	0.870

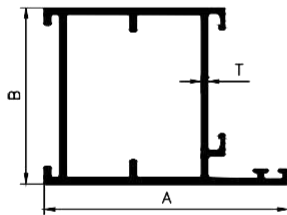

Sr.No.	Section No.	A	B	T	Wt. Kg/Mtr.
1	ART 19022	55.30	40.00	1.50	0.783

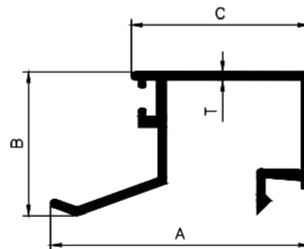

Sr.No.	Section No.	A	B	C	T	Wt. Kg/Mtr.
1	ART 17033	32.00	17.72	22.00	1.00	0.210
2	ART 17091	32.00	17.72	26.00	1.00	0.213

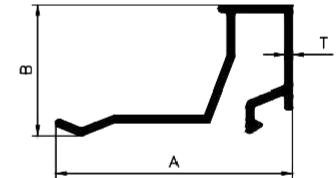

Sr.No.	Section No.	A	B	T	Wt. Kg/Mtr.
1	ART 17050	32.14	17.80	1.00	0.187

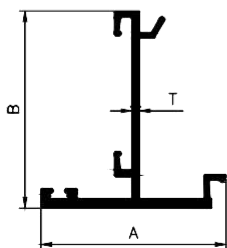

Sr.No.	Section No.	A	B	T	Wt. Kg/Mtr.
1	ART 19014	37.70	40.00	1.50	0.433

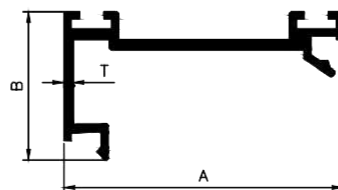

Sr.No.	Section No.	A	B	T	Wt. Kg/Mtr.
1	ART 17918	40.00	21.28	1.30	0.305

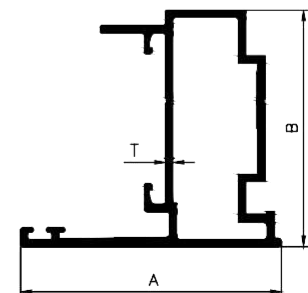

Sr.No.	Section No.	A	B	T	Wt. Kg/Mtr.
1	ART 19002	47.30	42.90	1.30	0.662

CASEMENT SERIES 40MM

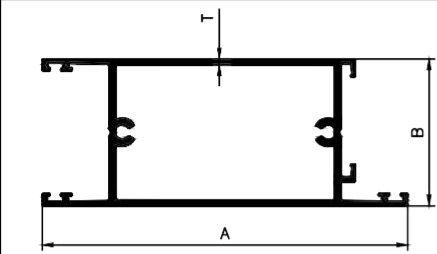

Sr.No.	Section No.	A	B	T	Wt. Kg/Mtr.
1	ART 12659	99.50	40.00	1.60	1.298

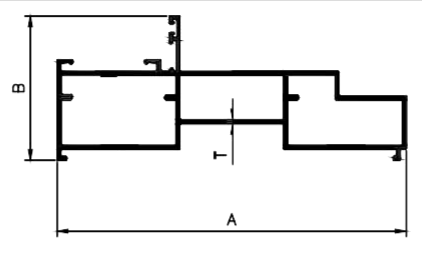

Sr.No.	Section No.	A	B	T	Wt. Kg/Mtr.
1	ART 17023	114.00	47.15	1.20	1.252

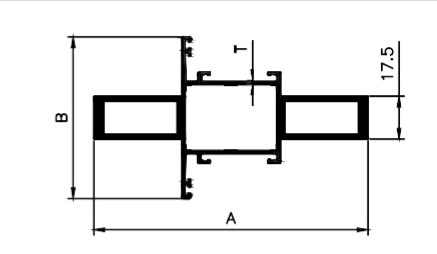

Sr.No.	Section No.	A	B	T	Wt. Kg/Mtr.
1	ART 19012	112.00	66.10	1.30	1.961

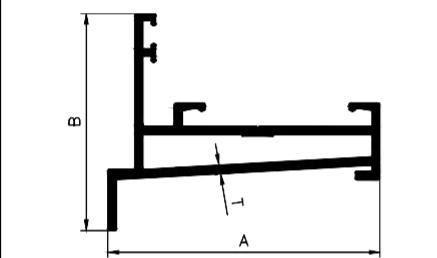

Sr.No.	Section No.	A	B	T	Wt. Kg/Mtr.
1	ARI 17008	44.40	35.40	1.40	0.515

CASEMENT SERIES 42MM

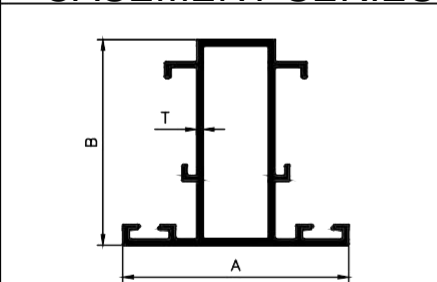

Sr.No.	Section No.	A	B	T	Wt. Kg/Mtr.
1	ART 12983	46.20	42.00	1.35	0.656

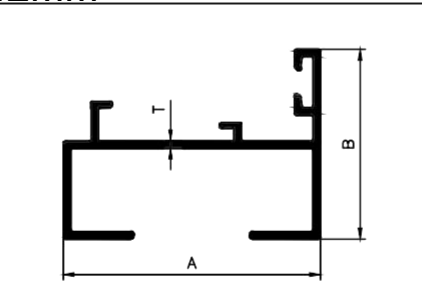

Sr.No.	Section No.	A	B	T	Wt. Kg/Mtr.
1	ART 12984	42.00	31.00	1.25	0.436

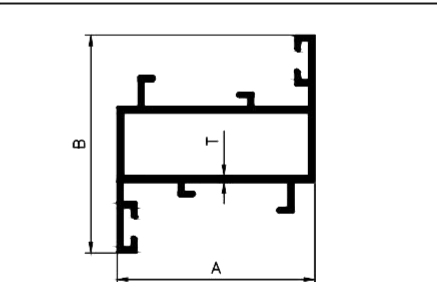

Sr.No.	Section No.	A	B	T	Wt. Kg/Mtr.
1	ART 12985	42.00	46.20	1.35	0.656

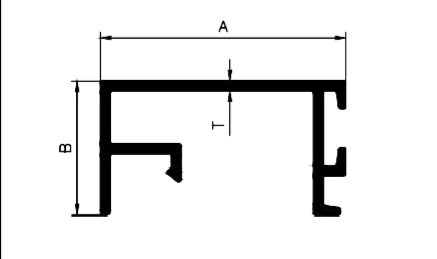

Sr.No.	Section No.	A	B	T	Wt. Kg/Mtr.
1	ARI 12986	28.00	15.30	1.11	0.226

CASEMENT SERIES 45MM

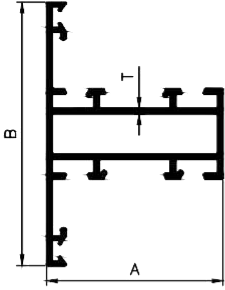

Sr.No.	Section No.	A	B	T	Wt. Kg/Mtr.
1	ART 12979	45.00	67.00	1.40	0.901

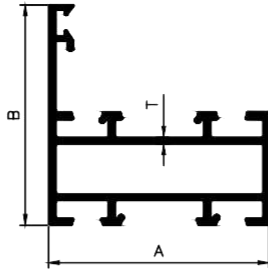

Sr.No.	Section No.	A	B	T	Wt. Kg/Mtr.
1	ART 12980	45.00	45.00	1.40	0.784

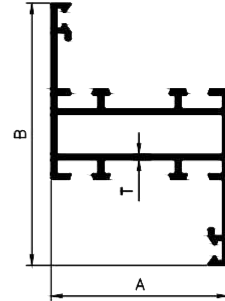

Sr.No.	Section No.	A	B	T	Wt. Kg/Mtr.
1	ART 17007	45.00	67.00	1.40	0.901

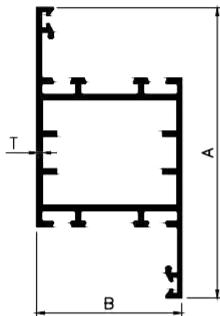

Sr.No.	Section No.	A	B	T	Wt. Kg/Mtr.
1	19047	90.00	45.00	1.60	1.238

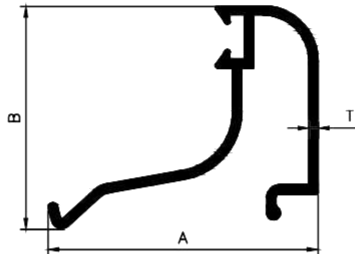

Sr.No.	Section No.	A	B	T	Wt. Kg/Mtr.
1	ART 12981	31.37	26.00	1.10	0.246

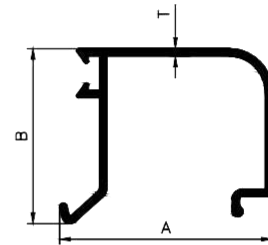

Sr.No.	Section No.	A	B	T	Wt. Kg/Mtr.
1	ART 12982	31.41	26.00	1.10	0.263

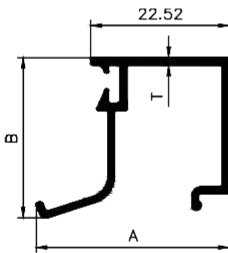

Sr.No.	Section No.	A	B	T	Wt. Kg/Mtr.
1	ART 17912	31.42	26.01	1.20	0.285

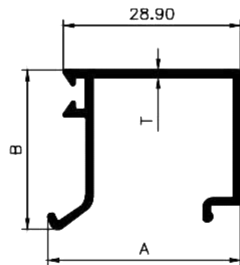

Sr.No.	Section No.	A	B	T	Wt. Kg/Mtr.
1	ART 17913	31.40	26.00	1.20	0.283

CASEMENT SERIES 45MM

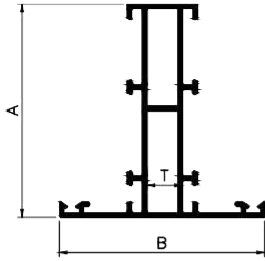

Sr.No.	Section No.	A	B	T	Wt. Kg/Mtr.
1	19026/A	69.48	67.00	1.40	1.125

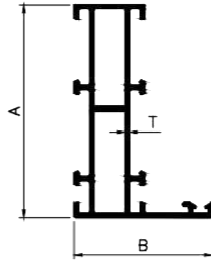

Sr.No.	Section No.	A	B	T	Wt. Kg/Mtr.
1	19027/A	69.48	45.00	1.40	1.009

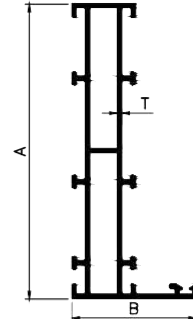

Sr.No.	Section No.	A	B	T	Wt. Kg/Mtr.
1	19028	107.00	45.00	1.40	1.354

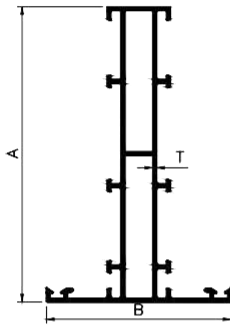

Sr.No.	Section No.	A	B	T	Wt. Kg/Mtr.
1	19029	107.00	67.00	1.40	1.464

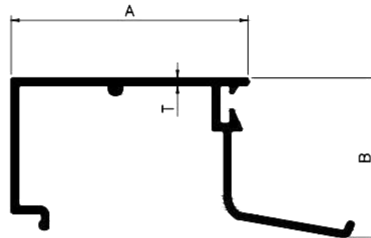

Sr.No.	Section No.	A	B	T	Wt. Kg/Mtr.
1	17926	38.67	26.00	1.20	0.370

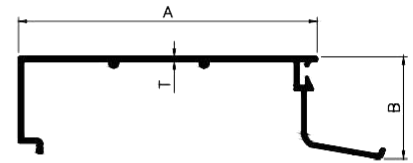

Sr.No.	Section No.	A	B	T	Wt. Kg/Mtr.
1	17927	76.20	26.00	1.20	0.500

CASEMENT SERIES 50MM

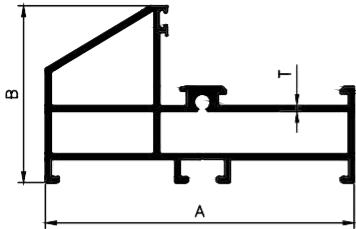

Sr.No.	Section No.	A	B	T	Wt. Kg/Mtr.
1	ART 19009	80.00	45.70	1.50	1.304

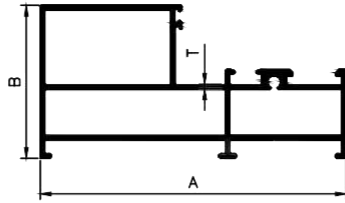

Sr.No.	Section No.	A	B	T	Wt. Kg/Mtr.
1	ART 19010	100.00	50.00	1.50	1.622

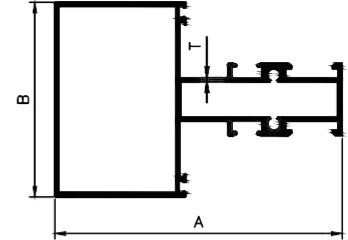

Sr.No.	Section No.	A	B	T	Wt. Kg/Mtr.
1	ART 19011	99.00	67.00	1.50	1.675

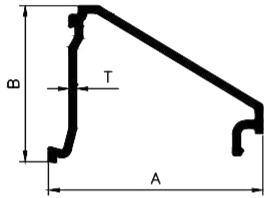

Sr.No.	Section No.	A	B	T	Wt. Kg/Mtr.
1	ARI 17063	35.03	25.50	1.20	0.243

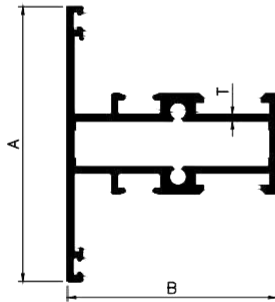

Sr.No.	Section No.	A	B	T	Wt. Kg/Mtr.
1	19051	66.00	50.00	1.40	0.999

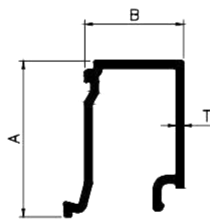

Sr.No.	Section No.	A	B	T	Wt. Kg/Mtr.
1	17954	25.50	16.00	1.20	0.229

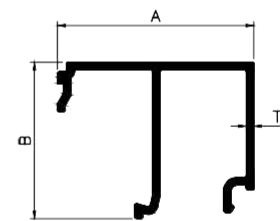

Sr.No.	Section No.	A	B	T	Wt. Kg/Mtr.
1	17955	32.00	25.50	1.20	0.302

CASEMENT SERIES 52MM

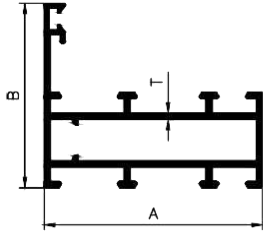

Sr.No.	Section No.	A	B	T	Wt. Kg/Mtr.
1	ART 12918	52.00	44.50	1.50	0.869

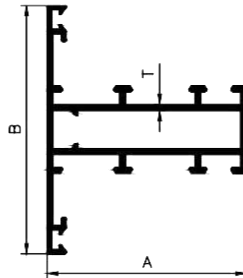

Sr.No.	Section No.	A	B	T	Wt. Kg/Mtr.
1	ART 12919	52.00	66.00	1.50	0.986

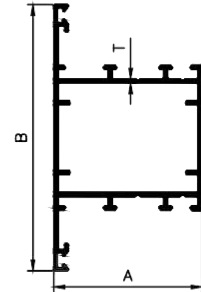

Sr.No.	Section No.	A	B	T	Wt. Kg/Mtr.
1	ARI 17144	52.00	95.00	1.50	1.268

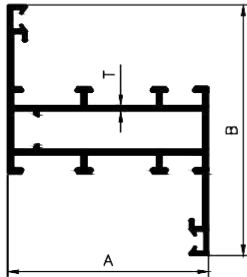

Sr.No.	Section No.	A	B	T	Wt. Kg/Mtr.
1	ART 12920	52.00	66.00	1.50	0.986

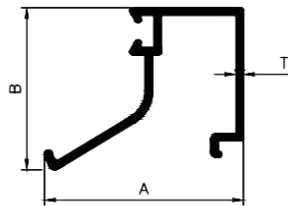

Sr.No.	Section No.	A	B	T	Wt. Kg/Mtr.
1	ART 12921	31.50	26.20	1.20	0.277

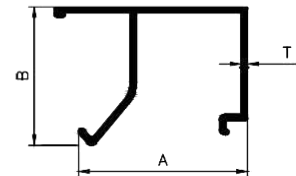

Sr.No.	Section No.	A	B	T	Wt. Kg/Mtr.
1	ART 12922	31.50	26.20	1.20	0.306

INSECT SCREEN SECTIONS

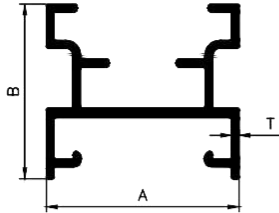

Sr.No.	Section No.	A	B	T	Wt. Kg/Mtr.
1	ART 17114	25.50	23.10	1.00	0.276

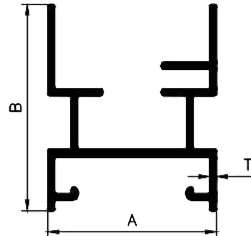

Sr.No.	Section No.	A	B	T	Wt. Kg/Mtr.
1	ART 17115	25.50	31.20	1.00	0.326

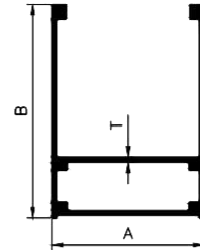

Sr.No.	Section No.	A	B	T	Wt. Kg/Mtr.
1	ART 17116	32.30	45.30	1.00	0.484

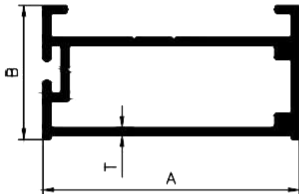

Sr.No.	Section No.	A	B	T	Wt. Kg/Mtr.
1	ART 17117	32.30	16.80	1.00	0.300

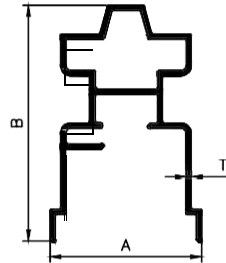

Sr.No.	Section No.	A	B	T	Wt. Kg/Mtr.
1	ART 17118	29.00	45.00	1.00	0.421

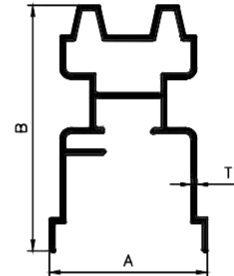

Sr.No.	Section No.	A	B	T	Wt. Kg/Mtr.
1	ART 17119	29.00	45.00	1.00	0.443

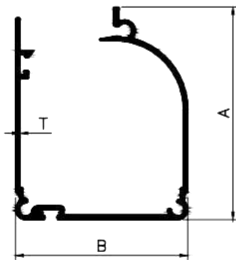

Sr.No.	Section No.	A	B	T	Wt. Kg/Mtr.
1	*17302	58.00	47.00	1.20	0.620

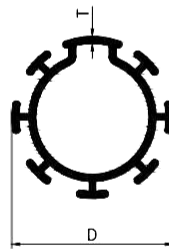

Sr.No.	Section No.	D	T	Wt. Kg/Mtr.
1	*17303	26.30	1.10	0.335

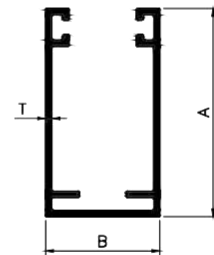

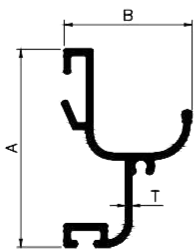

Sr.No.	Section No.	A	B	T	Wt. Kg/Mtr.
1	*17304	40.00	22.00	1.20	0.413

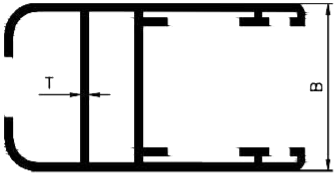
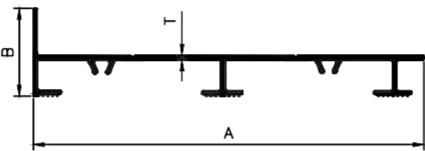
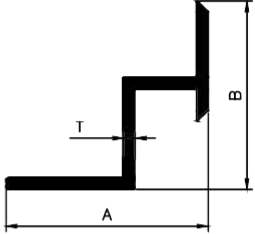
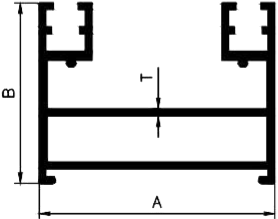
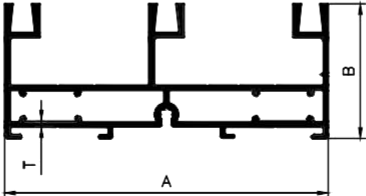
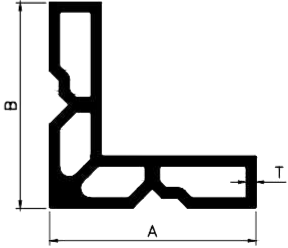
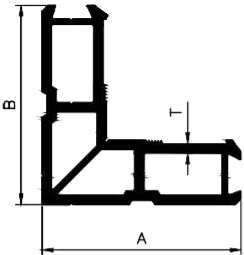
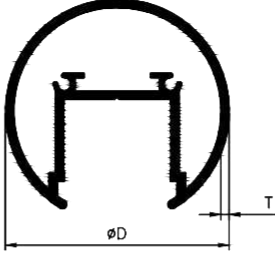
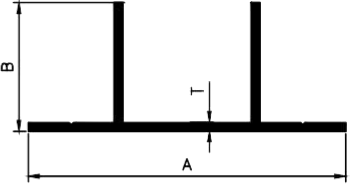
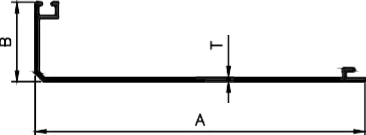

Sr.No.	Section No.	A	B	T	Wt. Kg/Mtr.
1	*17305	38.00	24.60	1.20	0.322

ARCHITECTURAL

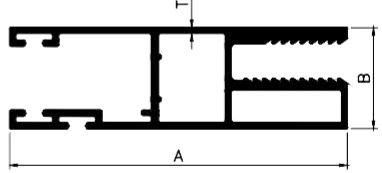
					SUB FRAME												
																	
Sr.No.	Section No.	A	B	T	Wt. Kg/Mtr.	Sr.No.	Section No.	A	B	T	Wt. Kg/Mtr.	Sr.No.	Section No.	A	B	T	Wt. Kg/Mtr.
1	ART 17001	61.00	34.00	1.50	0.924	1	ART 17024	125.00	28.00	1.50	0.864	1	ART 12162	22.00	20.50	1.30	0.153
																	
Sr.No.	Section No.	A	B	T	Wt. Kg/Mtr.	Sr.No.	Section No.	A	B	T	Wt. Kg/Mtr.	Sr.No.	Section No.	A	B	T	Wt. Kg/Mtr.
1	ART 17009	58.43	40.95	1.50	1.051	1	ART 12515	96.10	40.00	1.70	1.680	1	17181	42.00	42.00	2.00	1.016
																	
Sr.No.	Section No.	A	B	T	Wt. Kg/Mtr.	Sr.No.	Section No.	D	T	Wt. Kg/Mtr.	Sr.No.	Section No.	A	B	T	Wt. Kg/Mtr.	
1	17078	69.00	69.00	3.00	2.290	1	12929	50.79	1.90	.091	1	ART 17092/A	78.00	30.00	2.00	0.700	
RAILING COVER					RAILING COVER												
																	
Sr.No.	Section No.	A	B	T	Wt. Kg/Mtr.	Sr.No.	Section No.	A	B	T	Wt. Kg/Mtr.	Sr.No.	Section No.	A	B	T	Wt. Kg/Mtr.
1	ART 17054	134.60	32.40	1.50	0.738	1	ART 17098	102.10	16.59	1.60	0.595	1	12759	72.00	21.50	1.20	0.984

ALL DIMENSIONS ARE IN MM.

WEIGHT TOLERANCES ± 7 TO 10%

CURTAIN WALL SECTIONS

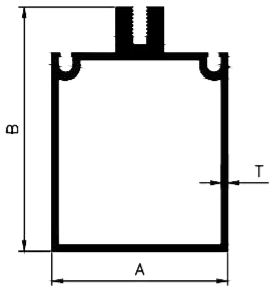

Sr.No.	Section No.	A	B	T	Wt. Kg/Mtr.
1	ART 12957	57.00	79.00	2.00	1.787

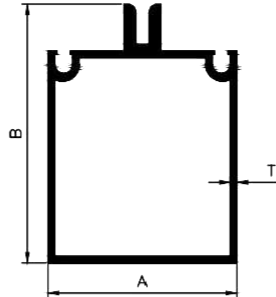

Sr.No.	Section No.	A	B	T	Wt. Kg/Mtr.
1	ART 12958	56.00	77.00	2.00	1.591

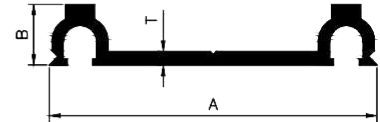

Sr.No.	Section No.	A	B	T	Wt. Kg/Mtr.
1	ART 12959	53.50	10.00	2.20	0.439

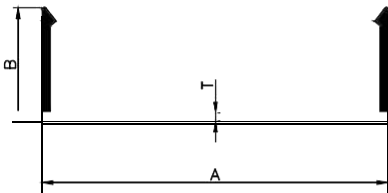

Sr.No.	Section No.	A	B	T	Wt. Kg/Mtr.
1	ART 12960	56.50	18.50	1.30	0.321

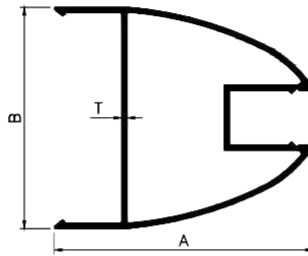

Sr.No.	Section No.	A	B	T	Wt. Kg/Mtr.
1	19504	82.67	56.50	1.30	0.962

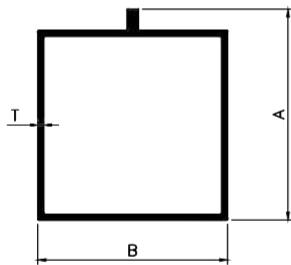

Sr.No.	Section No.	A	B	T	Wt. Kg/Mtr.
1	ART 15521	49.20	44.20	1.30	0.636

UNITISED SECTIONS

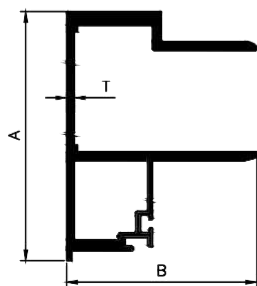

Sr.No.	Section No.	A	B	T	Wt. Kg/Mtr.
1	ARI 17043	72.50	55.30	2.20	1.576

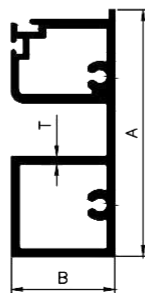

Sr.No.	Section No.	A	B	T	Wt. Kg/Mtr.
1	ART 17044	72.00	30.00	2.20	1.486

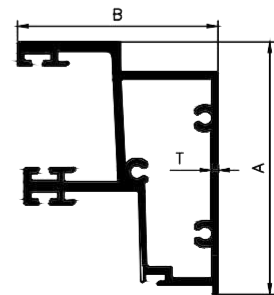

Sr.No.	Section No.	A	B	T	Wt. Kg/Mtr.
1	ART 17046	81.80	64.95	2.20	2.284

55MM SEMI UNITISED SECTIONS

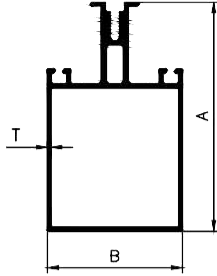

Sr.No	Section No.	A	B	T	Wt. Kg/Mtr.
1	ARI 17071	93.50	55.00	1.45	1.576

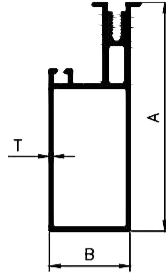

Sr.No	Section No.	A	B	T	Wt. Kg/Mtr.
1	ART 17077	93.50	33.00	1.45	1.316

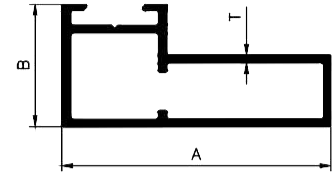

Sr.No	Section No.	A	B	T	Wt. Kg/Mtr.
1	ART 17075	44.00	19.90	1.20	0.440

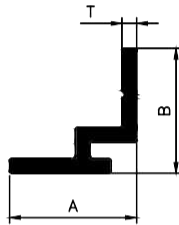

Sr.No	Section No.	A	B	T	Wt. Kg/Mtr.
1	ARI 17076	17.30	17.00	2.00	0.190

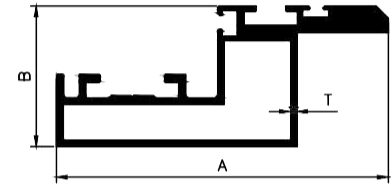

Sr.No	Section No.	A	B	T	Wt. Kg/Mtr.
1	12901	72.28	30.64	1.40	1.053

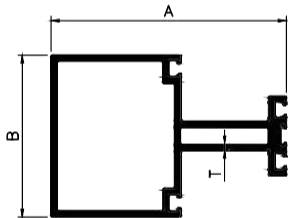

Sr.No	Section No.	A	B	T	Wt. Kg/Mtr.
1	19512	80.00	55.00	2.00	1.702

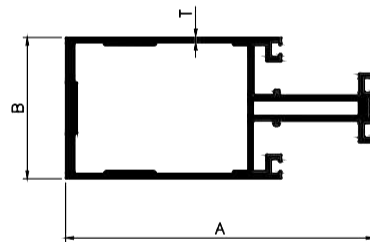

Sr.No	Section No.	A	B	T	Wt. Kg/Mtr.
1	19513	120.00	55.00	2.00	2.782

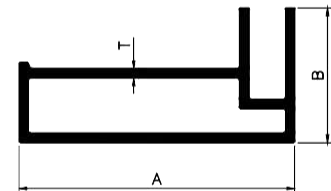

Sr.No	Section No.	A	B	T	Wt. Kg/Mtr.
1	19514	45.00	22.00	1.50	0.542

67MM SEMI UNITISED SECTIONS

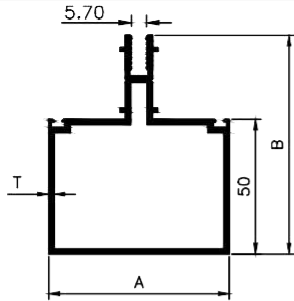

Sr.No.	Section No.	A	B	T	Wt. Kg/Mtr.
1	ART 19502	67.00	81.16	2.00	1.615

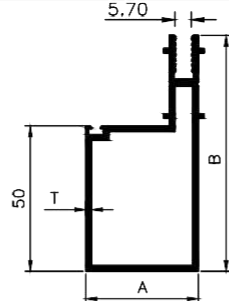

Sr.No.	Section No.	A	B	T	Wt. Kg/Mtr.
1	ART 19503	38.50	81.16	2.00	1.294

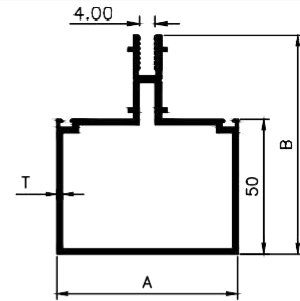

Sr.No.	Section No.	A	B	T	Wt. Kg/Mtr.
1	ART 19505	67.00	81.16	2.00	1.684

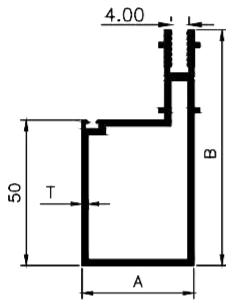

Sr.No.	Section No.	A	B	T	Wt. Kg/Mtr.
1	ART 19506	38.50	81.16	2.00	1.363

SLIDING & FOLDING SERIES

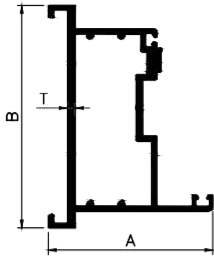

Sr.No.	Section No.	A	B	T	Wt. Kg/Mtr.
1	17176	52.50	71.00	2.50	1.238

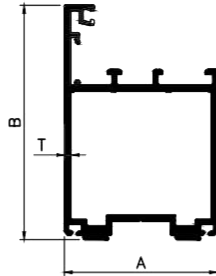

Sr.No.	Section No.	A	B	T	Wt. Kg/Mtr.
1	17177	50.00	76.50	2.00	1.477

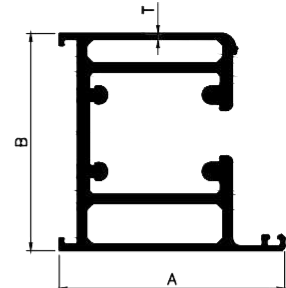

Sr.No.	Section No.	A	B	T	Wt. Kg/Mtr.
1	17178	73.75	71.00	2.00	2.921

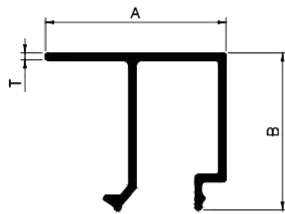

Sr.No.	Section No.	A	B	T	Wt. Kg/Mtr.
1	17951	29.40	25.90	1.15	0.265

LOUVER SECTIONS

LOUVERS PLATE

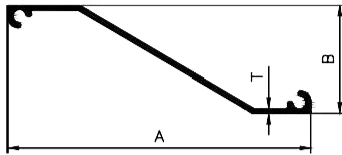

Sr.No.	Section No.	A	B	T	Wt. Kg/Mtr.
1	ARI 12114	63.00	10.55	1.15	0.250
2	ARI 12111	77.60	27.60	1.20	0.326
3	ART 17143	77.60	27.80	1.40	0.368

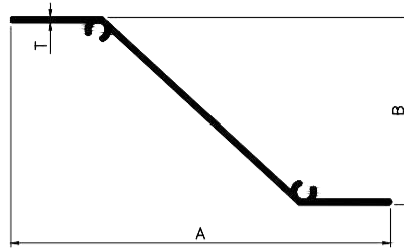

Sr.No.	Section No.	A	B	T	Wt. Kg/Mtr.
1	20000	37.72	32.50	1.30	0.248
2	17272	103.20	50.80	1.40	0.519

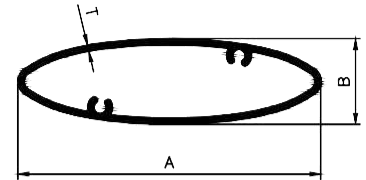

Sr.No.	Section No.	A	B	T	Wt. Kg/Mtr.
1	ART 17074	75.00	21.25	1.50	0.706

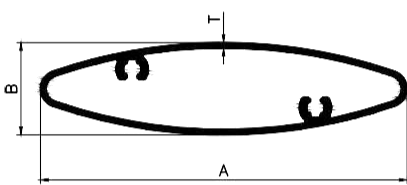

Sr.No.	Section No.	A	B	T	Wt. Kg/Mtr.
1	ART 20001	100.00	25.00	1.50	1.014

LOUVERS PLATE

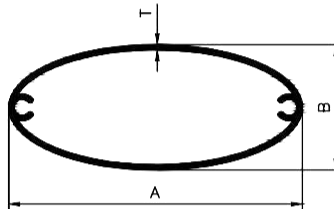

Sr.No.	Section No.	A	B	T	Wt. Kg/Mtr.
1	ART 12161	75.00	32.00	1.30	0.665

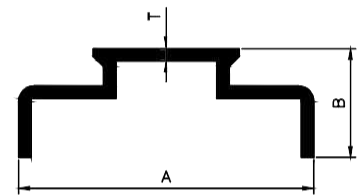

Sr.No.	Section No.	A	B	T	Wt. Kg/Mtr.
1	ART 12926	38.00	14.00	1.60	0.278

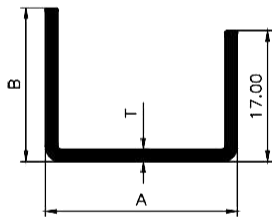

Sr.No.	Section No.	A	B	T	Wt. Kg/Mtr.
1	ARI 12927	25.00	20.00	1.60	0.249

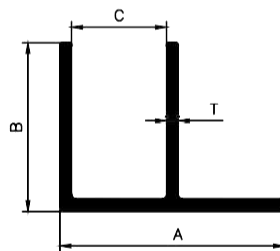

Sr.No.	Section No.	A	B	C	T	Wt. Kg/Mtr.
1	ART 12210	21.30	16.00	9.00	1.10	0.151
2	ART 12928	23.40	15.30	8.00	1.40	0.193

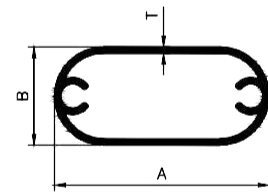

Sr.No.	Section No.	A	B	T	Wt. Kg/Mtr.
1	ART 17141	35.00	16.00	1.00	0.280

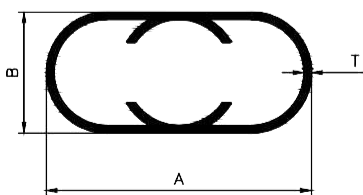

Sr.No.	Section No.	A	B	T	Wt. Kg/Mtr.
1	ART 17055	35.00	16.00	1.00	0.283

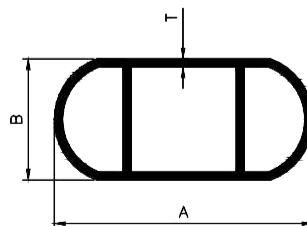

Sr.No.	Section No.	A	B	T	Wt. Kg/Mtr.
1	ART 17031	32.00	15.00	1.00	0.283

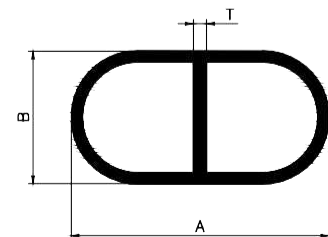

Sr.No.	Section No.	A	B	T	Wt. Kg/Mtr.
1	* 17238	35.00	18.00	1.50	0.420

ALL DIMENSIONS ARE IN MM.

WEIGHT TOLERANCES ± 7 TO 10%

MAY-2020

PAGE 28

LOUVER SECTIONS

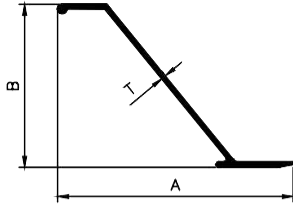

Sr.No.	Section No.	A	B	T	Wt. Kg/Mtr.
1	ART 17120	87.50	60.45	1.60	0.556

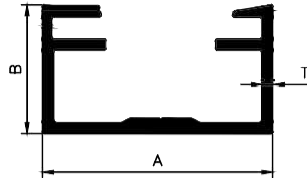

Sr.No.	Section No.	A	B	T	Wt. Kg/Mtr.
1	ART 17121	37.60	21.00	1.80	0.510

LOUVERS BRACKET

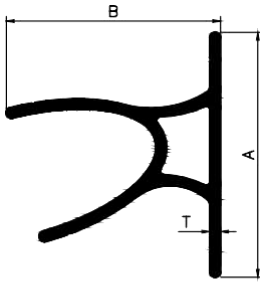

Sr.No.	Section No.	A	B	T	Wt. Kg/Mtr.
1	17233	66.97	58.80	3.00	1.553

LOUVERS BRACKET

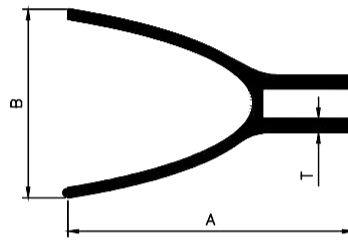

Sr.No.	Section No.	A	B	T	Wt. Kg/Mtr.
1	ARI 17045	97.50	56.08	4.00	2.003

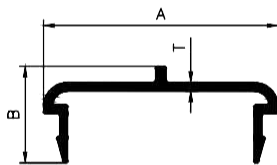

Sr.No.	Section No.	A	B	T	Wt. Kg/Mtr.
1	ART 17910	29.00	12.00	1.10	0.147

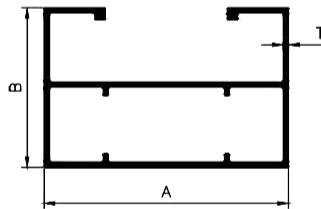

Sr.No.	Section No.	A	B	T	Wt. Kg/Mtr.
1	ART 17123	50.00	32.70	1.10	0.580

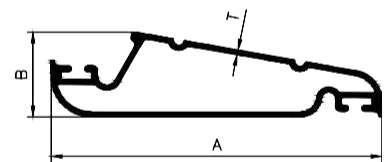

Sr.No.	Section No.	A	B	T	Wt. Kg/Mtr.
1	ART 17122	70.00	17.95	1.00	0.508

ACP Cladding

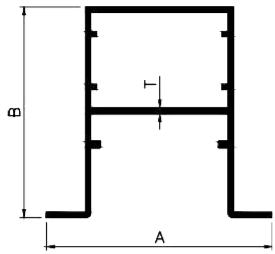

Sr.No.	Section No.	A	B	T	Wt. Kg/Mtr.
1	17274	92.00	85.70	2.50	1.886

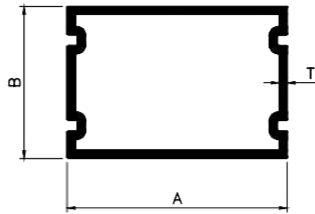

Sr.No.	Section No.	A	B	T	Wt. Kg/Mtr.
1	17275	55.20	38.20	2.00	1.048

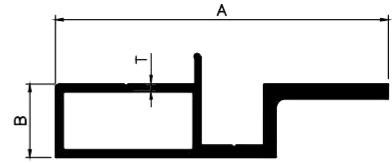

Sr.No.	Section No.	A	B	T	Wt. Kg/Mtr.
1	19900	67.95	15.00	1.60	0.751

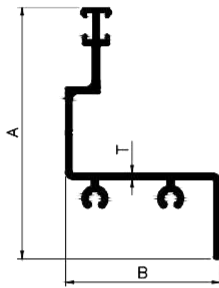

Sr.No.	Section No.	A	B	T	Wt. Kg/Mtr.
1	19901	73.17	45.00	1.80	0.832

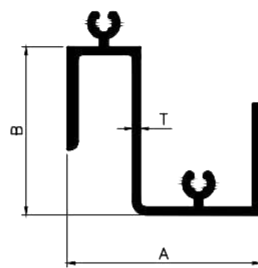

Sr.No.	Section No.	A	B	T	Wt. Kg/Mtr.
1	19902	45.00	38.97	1.80	0.810

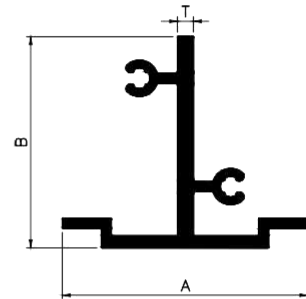

Sr.No.	Section No.	A	B	T	Wt. Kg/Mtr.
1	19903	50.00	43.10	3.30	0.889

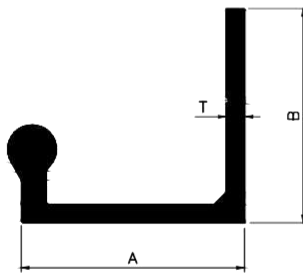

Sr.No.	Section No.	A	B	T	Wt. Kg/Mtr.
1	19904/A	36.43	35.00	4.00	0.916

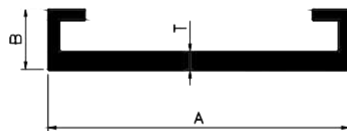

Sr.No.	Section No.	A	B	T	Wt. Kg/Mtr.
1	19905	82.00	16.50	5.00	1.406

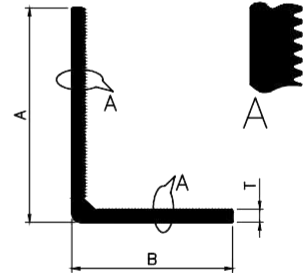

Sr.No.	Section No.	A	B	T	Wt. Kg/Mtr.
1	13601	100.00	75.00	6.00	2.534

KITCHEN SECTIONS

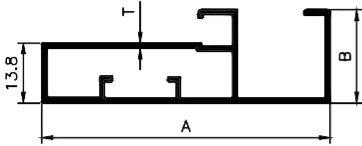

Sr.No.	Section No.	A	B	T	Wt. Kg/Mtr.
1	ART 12140	66.40	21.50	1.15	0.601
2	ART 14070	66.40	21.50	1.40	0.685

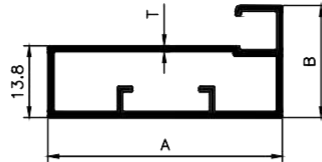

Sr.No.	Section No.	A	B	T	Wt. Kg/Mtr.
1	ART 12141	45.00	21.50	1.15	0.451
1	ART 14071	45.00	21.50	1.35	0.500

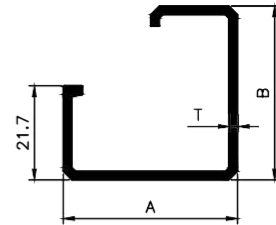

Sr.No.	Section No.	A	B	T	Wt. Kg/Mtr.
1	ART 12143	40.10	40.10	2.00	0.637

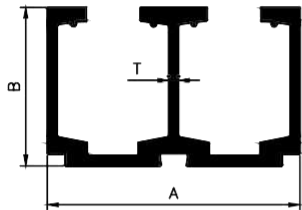

Sr.No.	Section No.	A	B	T	Wt. Kg/Mtr.
1	ART 14055	64.60	40.60	2.50	1.782

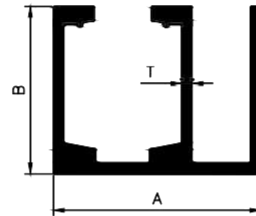

Sr.No.	Section No.	A	B	T	Wt. Kg/Mtr.
1	ART 14056	50.30	40.60	2.50	1.471

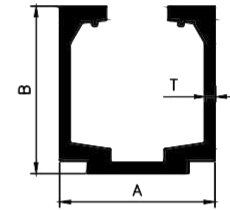

Sr.No.	Section No.	A	B	T	Wt. Kg/Mtr.
1	ART 14057	37.60	40.60	2.50	1.124

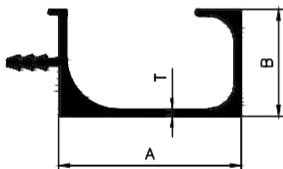

Sr.No.	Section No.	A	B	T	Wt. Kg/Mtr.
1	ART 12146	35.00	20.50	1.30	0.438

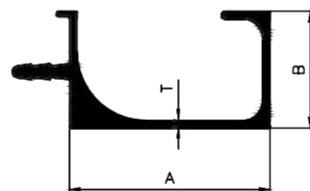

Sr.No.	Section No.	A	B	T	Wt. Kg/Mtr.
1	ARI 14063	35.00	20.40	1.00	0.364
2	ARI 14058	35.00	20.40	1.30	0.450
3	ARI 14108	35.00	20.40	1.65	0.519

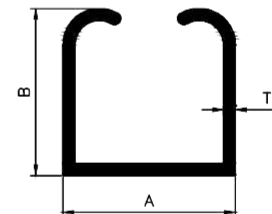

Sr.No.	Section No.	A	B	T	Wt. Kg/Mtr.
1	ART 12187	33.10	32.10	2.30	0.652

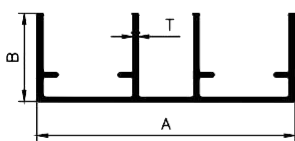

Sr.No.	Section No.	A	B	T	Wt. Kg/Mtr.
1	ART 14064	58.60	20.00	1.20	0.451

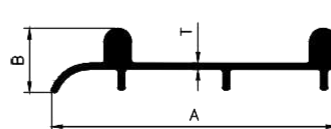

Sr.No.	Section No.	A	B	T	Wt. Kg/Mtr.
1	ART 14065	49.00	11.00	1.00	0.310

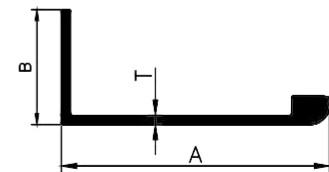

Sr.No.	Section No.	A	B	T	Wt. Kg/Mtr.
1	ART 14053	42.00	18.00	1.40	0.266

KITCHEN SECTIONS

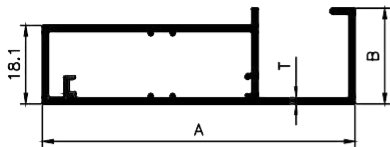

Sr.No.	Section No.	A	B	T	Wt. Kg/Mtr.
1	ART 12203	72.00	22.10	1.40	0.719

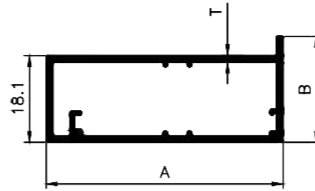

Sr.No.	Section No.	A	B	T	Wt. Kg/Mtr.
1	ART 12204	49.60	22.10	1.40	0.541

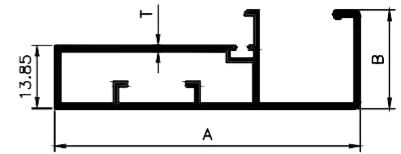

Sr.No.	Section No.	A	B	T	Wt. Kg/Mtr.
1	ART 14059	67.00	21.70	1.30	0.641

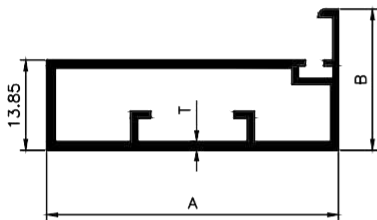

Sr.No.	Section No.	A	B	T	Wt. Kg/Mtr.
1	ART 14060	44.80	21.70	1.30	0.455

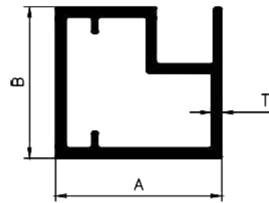

Sr.No.	Section No.	A	B	T	Wt. Kg/Mtr.
1	ART 14061	22.00	20.00	1.40	0.320

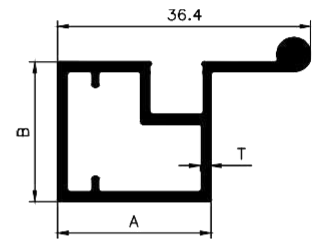

Sr.No.	Section No.	A	B	T	Wt. Kg/Mtr.
1	ART 14062	22.00	20.00	1.40	0.416

GLAZING SECTION

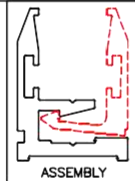
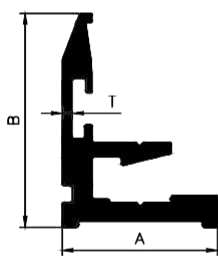

Sr.No.	Section No.	A	B	T	Wt. Kg/Mtr.
1	ART 12168	25.40	35.00	1.60	0.624
2	ART 12941	25.50	35.00	1.50	0.599

GLAZING SECTION

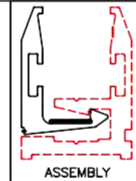
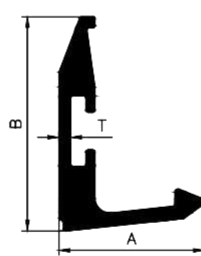

Sr.No.	Section No.	A	B	T	Wt. Kg/Mtr.
1	ART 12169	19.90	29.30	1.60	0.354
2	ART 12940	20.00	29.50	1.50	0.348

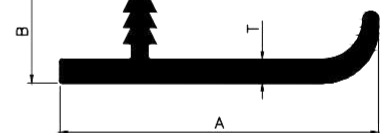

Sr.No.	Section No.	A	B	T	Wt. Kg/Mtr.
1	14073	40.00	13.00	3.00	0.417

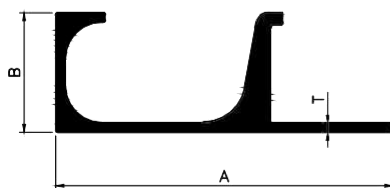

Sr.No.	Section No.	A	B	T	Wt. Kg/Mtr.
1	14074	55.00	19.50	1.50	0.567

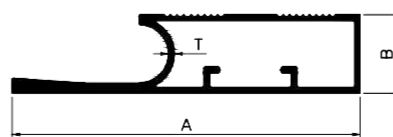

Sr.No.	Section No.	A	B	T	Wt. Kg/Mtr.
1	14088	71.00	41.30	1.15	0.564

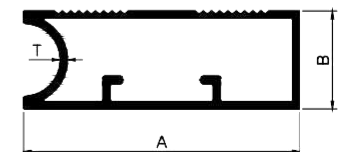

Sr.No.	Section No.	A	B	T	Wt. Kg/Mtr.
1	14089	45.00	16.00	1.50	0.404

WINDOW BLINDS & CURTAIN SECTIONS

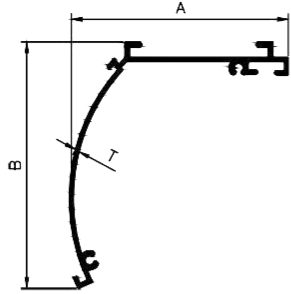

Sr.No.	Section No.	A	B	T	Wt. Kg/Mtr.
1	ART 17101	68.10	80.98	1.10	0.598
2	ART 12158	68.00	79.00	1.20	0.634

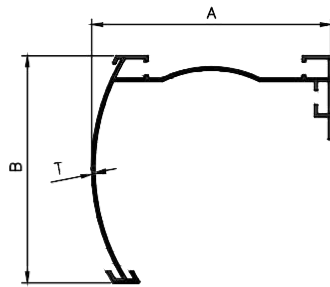

Sr.No.	Section No.	A	B	T	Wt. Kg/Mtr.
1	ART 12159	74.00	70.00	0.95	0.549

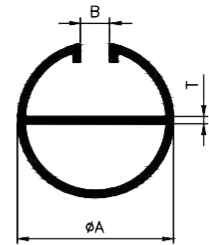

Sr.No.	Section No.	A	B	T	Wt. Kg/Mtr.
1	ART 12160	21.25	4.00	1.00	0.220

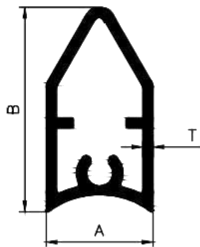

Sr.No.	Section No.	A	B	T	Wt. Kg/Mtr.
1	ARI 12181	12.50	24.00	1.20	0.232

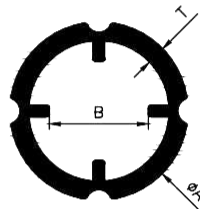

Sr.No.	Section No.	A	B	T	Wt. Kg/Mtr.
1	ARI 12182	15.30	8.50	1.60	0.189

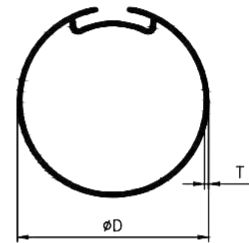

Sr.No.	Section No.	D	T	Wt. Kg/Mtr.
1	ART 12902	39.50	0.90	0.331

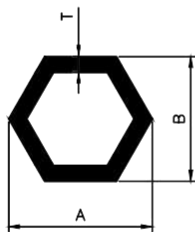

Sr.No.	Section No.	A	B	T	Wt. Kg/Mtr.
1	ARI 12917	8.20	7.10	0.90	0.052

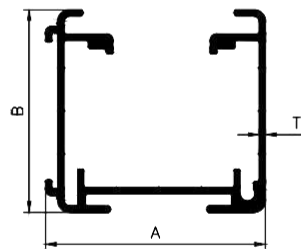

Sr.No.	Section No.	A	B	T	Wt. Kg/Mtr.
1	12963/A	36.20	33.20	1.00	0.442

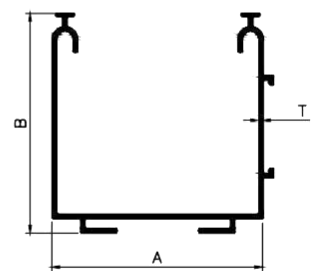

Sr.No.	Section No.	A	B	T	Wt. Kg/Mtr.
1	ARI 17130/A	61.00	58.50	1.20	0.744

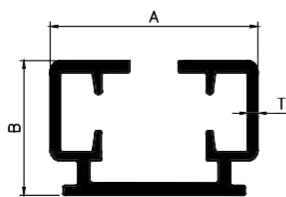

Sr.No.	Section No.	A	B	T	Wt. Kg/Mtr.
1	17175	34.00	22.00	1.70	0.557

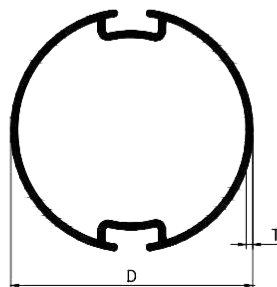

Sr.No.	Section No.	D	T	Wt. Kg/Mtr.
1	ART 17258	39.60	1.05	0.398

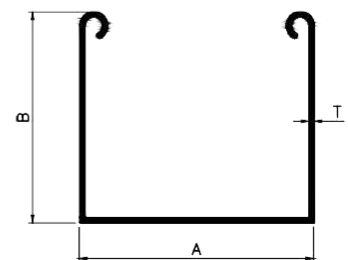

Sr.No.	Section No.	A	B	T	Wt. Kg/Mtr.
1	17259	59.00	53.00	1.30	0.632

ARCHITECTURAL

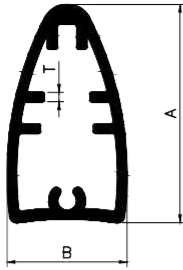

Sr.No.	Section No.	A	B	T	Wt. Kg/Mtr.
1	17263	29.80	15.60	1.40	0.364

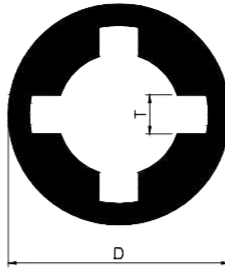

Sr.No.	Section No.	D	T	Wt. Kg/Mtr.
1	17264/A	18.00	3.20	0.384

SOLAR SECTIONS

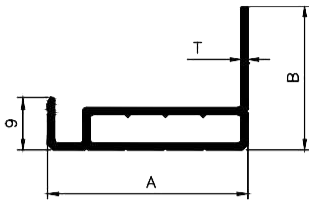

Sr.No.	Section No.	A	B	T	Wt. Kg/Mtr.
1	ART 11201	35.00	25.00	1.20	0.317

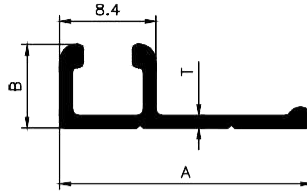

Sr.No.	Section No.	A	B	T	Wt. Kg/Mtr.
1	ART 11202	22.00	7.30	1.10	0.110

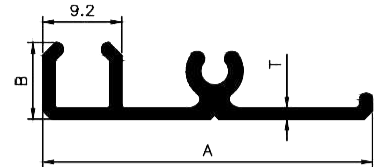

Sr.No.	Section No.	A	B	T	Wt. Kg/Mtr.
1	ART 11203	38.40	8.90	1.30	0.276

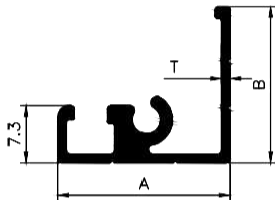

Sr.No.	Section No.	A	B	T	Wt. Kg/Mtr.
1	ART 11204	22.00	20.00	1.10	0.232

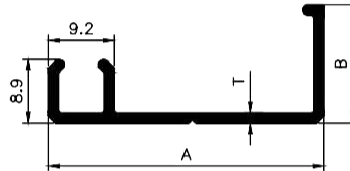

Sr.No.	Section No.	A	B	T	Wt. Kg/Mtr.
1	ART 11205	38.40	16.50	1.40	0.262

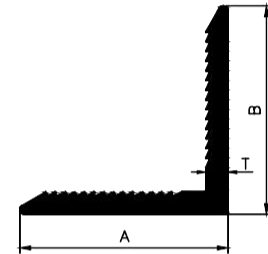

Sr.No.	Section No.	A	B	T	Wt. Kg/Mtr.
1	ART 11206	43.00	43.00	4.60	0.902

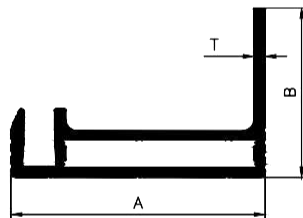

Sr.No.	Section No.	A	B	T	Wt. Kg/Mtr.
1	ART 11207	45.00	30.00	2.00	0.610

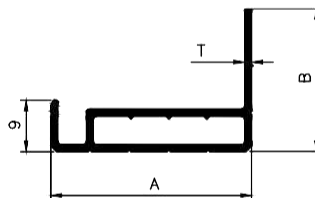

Sr.No.	Section No.	A	B	T	Wt. Kg/Mtr.
1	ART 11208	35.00	30.00	1.20	0.334

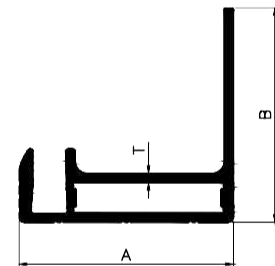

Sr.No.	Section No.	A	B	T	Wt. Kg/Mtr.
1	ART 11214	35.00	35.00	1.50	0.474

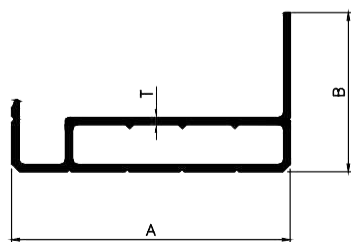

Sr.No.	Section No.	A	B	T	Wt. Kg/Mtr.
1	11215	35.00	20.00	0.90	0.228

LIFT SECTIONS

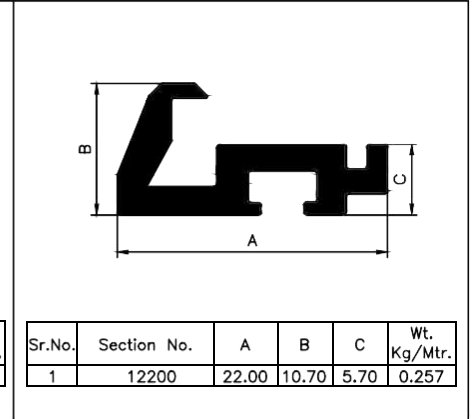
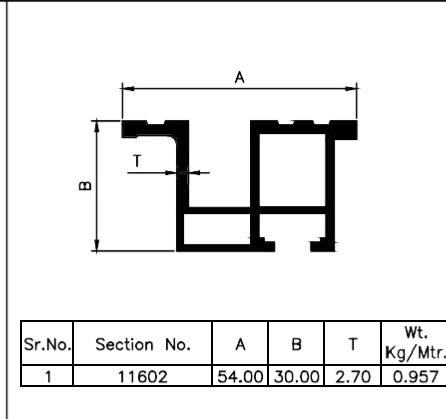
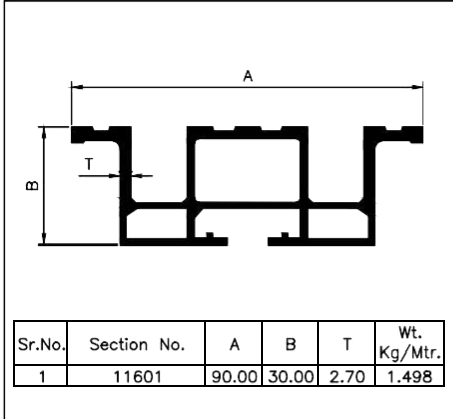

LED SECTIONS

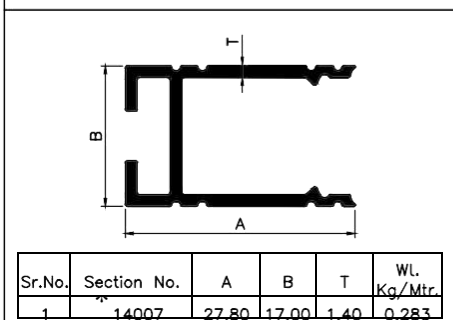
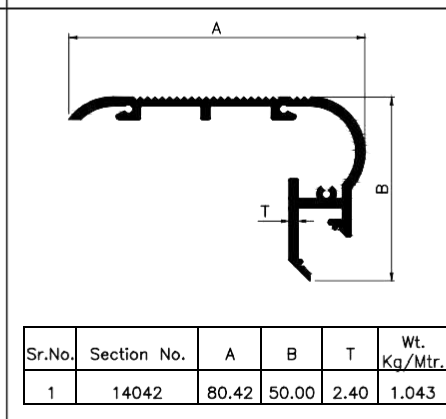
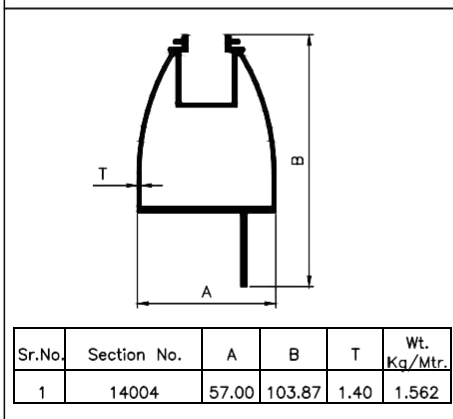
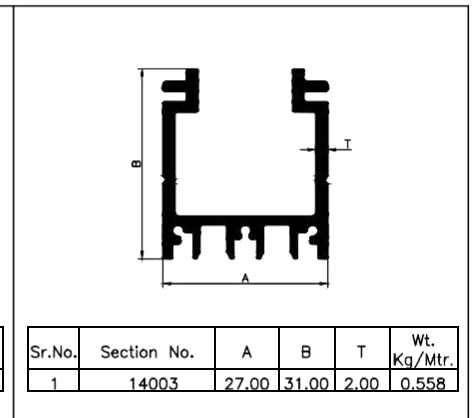
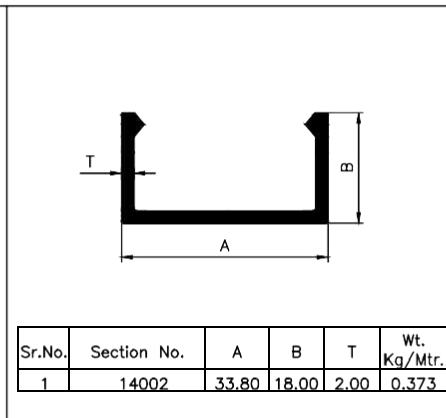
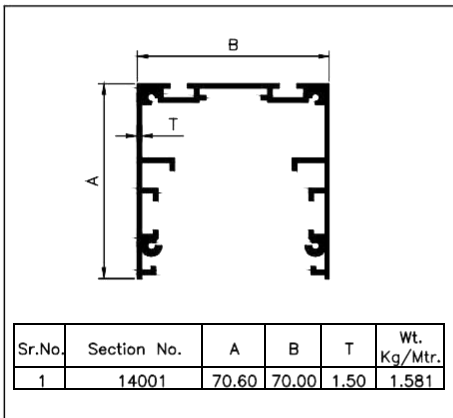

SPECIAL SECTION

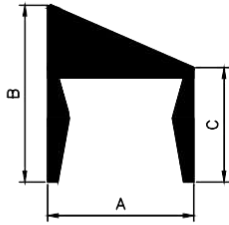

Sr.No.	Section No.	A	B	C	Wt. Kg/Mtr.
1	12903	11.50	13.87	8.97	0.158

BOARD SECTION

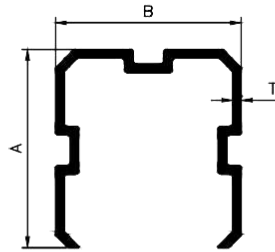

Sr.No.	Section No.	A	B	T	Wt. Kg/Mtr.
1	12987	16.20	15.20	0.70	0.100

OPTICAL SECTION

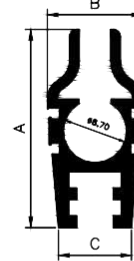

Sr.No.	Section No.	A	B	C	Wt. Kg/Mtr.
1	17010	27.00	13.00	10.00	0.306

MODULAR FURNITURE SECTION

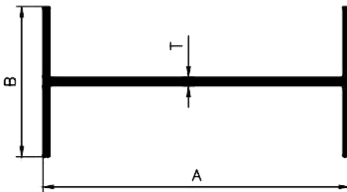

Sr.No.	Section No.	A	B	T	Wt. Kg/Mtr.
1	12999	55.70	27.30	1.50	0.393

MODULAR FURNITURE SECTION

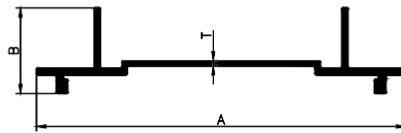

Sr.No.	Section No.	A	B	T	Wt. Kg/Mtr.
1	13000	80.00	18.50	1.10	0.428

TEXTILE SECTIONS

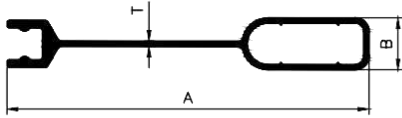

Sr.No.	Section No.	A	B	T	Wt. Kg/Mtr.
1	11731	82.20	12.00	1.20	0.514

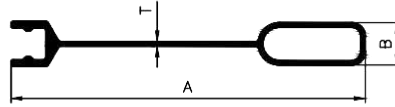

Sr.No.	Section No.	A	B	T	Wt. Kg/Mtr.
1	15601	82.20	10.00	1.10	0.440

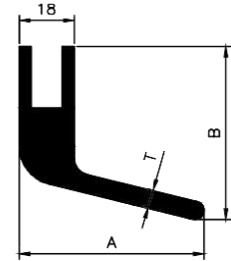

Sr.No.	Section No.	A	B	T	Wt. Kg/Mtr.
1	11732	60.50	57.63	6.00	2.306
2	15608	60.50	57.63	7.00	2.427

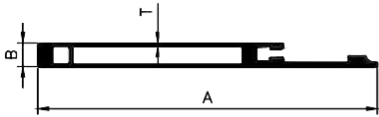

Sr.No.	Section No.	A	B	T	Wt. Kg/Mtr.
1	11736	128.60	9.10	1.05	1.050

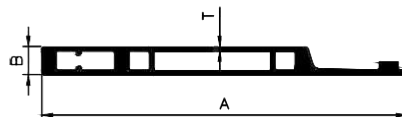

Sr.No.	Section No.	A	B	T	Wt. Kg/Mtr.
1	15609	119.50	9.10	1.30	1.096

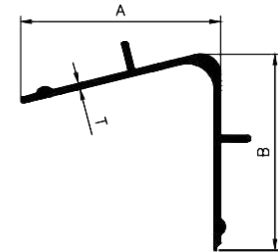

Sr.No.	Section No.	A	B	T	Wt. Kg/Mtr.
1	11735	68.20	68.10	2.10	0.956

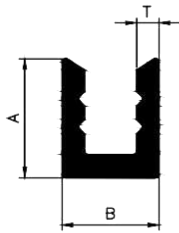

Sr.No.	Section No.	A	B	T	Wt. Kg/Mtr.
1	11738	10.00	8.00	1.85	0.115

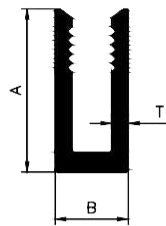

Sr.No.	Section No.	A	B	T	Wt. Kg/Mtr.
1	11739	18.00	7.90	1.80	0.190

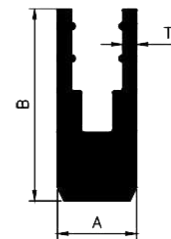

Sr.No.	Section No.	A	B	T	Wt. Kg/Mtr.
1	11744	9.60	23.70	1.70	0.391

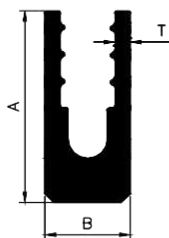

Sr.No.	Section No.	A	B	T	Wt. Kg/Mtr.
1	15603	21.30	9.30	1.65	0.301

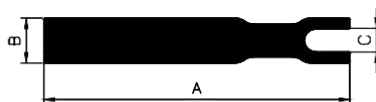

Sr.No.	Section No.	A	B	C	Wt. Kg/Mtr.
1	11734	68.50	10.20	5.20	1.657

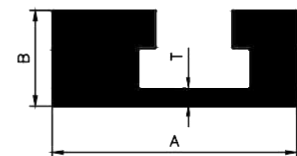

Sr.No.	Section No.	A	B	T	Wt. Kg/Mtr.
1	15607	50.00	20.00	3.60	1.850

TEXTILE SECTIONS

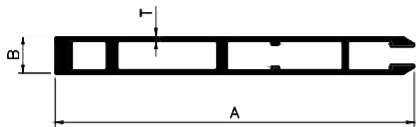

Sr.No.	Section No.	A	B	T	Wt. Kg/Mtr.
1	15611	90.20	9.20	1.00	0.736

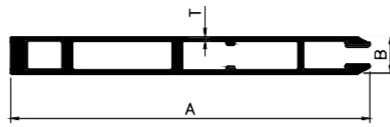

Sr.No.	Section No.	A	B	T	Wt. Kg/Mtr.
1	21519	90.20	9.20	1.00	0.735

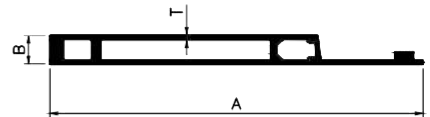

Sr.No.	Section No.	A	B	T	Wt. Kg/Mtr.
1	21513	119.50	9.20	1.30	0.975

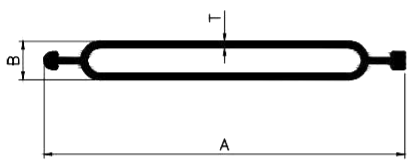

Sr.No.	Section No.	A	B	T	Wt. Kg/Mtr.
1	15610	84.30	9.00	1.50	0.668

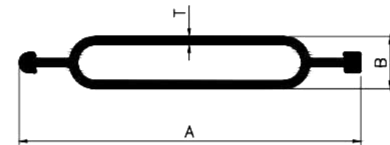

Sr.No.	Section No.	A	B	T	Wt. Kg/Mtr.
1	21516	58.60	9.00	1.40	0.425

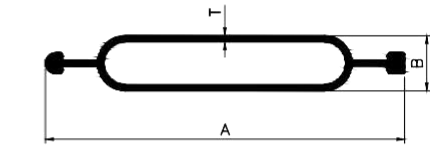

Sr.No.	Section No.	A	B	T	Wt. Kg/Mtr.
1	21517	58.60	9.00	1.00	0.321

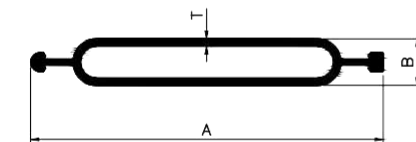

Sr.No.	Section No.	A	B	T	Wt. Kg/Mtr.
1	21518	71.80	9.50	1.50	0.556

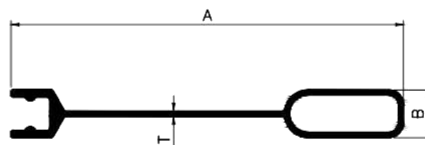

Sr.No.	Section No.	A	B	T	Wt. Kg/Mtr.
1	* 15614	82.20	10.00	1.10	0.439



Sr.No.	Section No.	A	B	T	Wt. Kg/Mtr.
1	* 21500	82.20	10.00	1.20	0.464

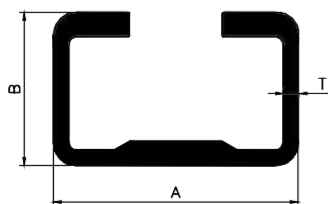

Sr.No.	Section No.	A	B	T	Wt. Kg/Mtr.
1	21508	40.00	25.00	2.50	0.832

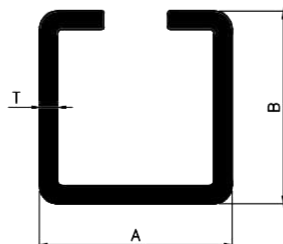

Sr.No.	Section No.	A	B	T	Wt. Kg/Mtr.
1	21520	21.00	21.00	2.00	0.364



Sr.No.	Section No.	A	B	C	Wt. Kg/Mtr.
1	* 23033	54.50	22.00	16.30	2.245

TEXTILE SECTIONS

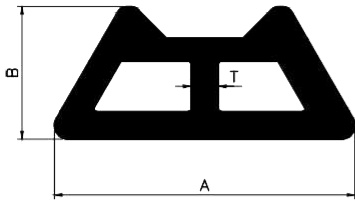

Sr.No.	Section No.	A	B	T	Wt. Kg/Mtr.
1	* 21511	32.80	14.50	3.00	0.664

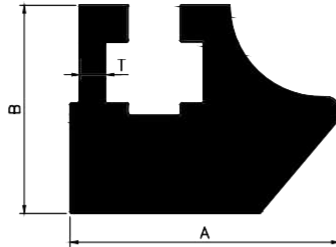

Sr.No.	Section No.	A	B	T	Wt. Kg/Mtr.
1	* 21512	44.00	34.00	4.25	2.486

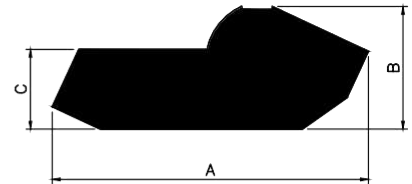

Sr.No.	Section No.	A	B	C	Wt. Kg/Mtr.
1	21514	51.65	20.00	13.00	1.884

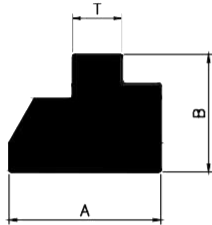

Sr.No.	Section No.	A	B	T	Wt. Kg/Mtr.
1	21515	15.50	12.00	5.00	0.374

AHU SECTIONS

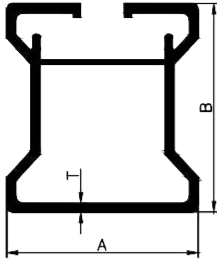

Sr.No.	Section No.	A	B	T	Wt. Kg/Mtr.
1	11707	55.00	60.00	2.50	1.705

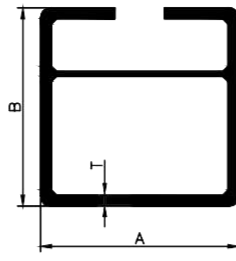

Sr.No.	Section No.	A	B	T	Wt. Kg/Mtr.
1	* 11708	40.00	40.00	2.20	0.936

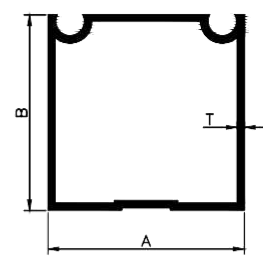

Sr.No.	Section No.	A	B	T	Wt. Kg/Mtr.
1	11709	40.00	40.00	1.40	0.618

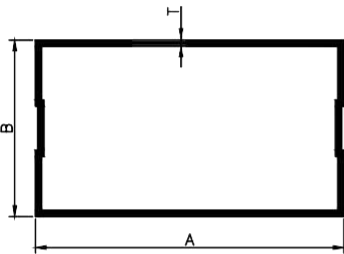

Sr.No.	Section No.	A	B	T	Wt. Kg/Mtr.
1	11710	70.00	40.00	1.40	0.818

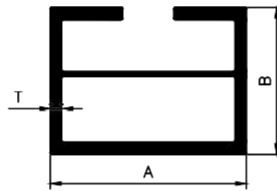

Sr.No.	Section No.	A	B	T	Wt. Kg/Mtr.
1	11716	40.00	30.00	1.30	0.875

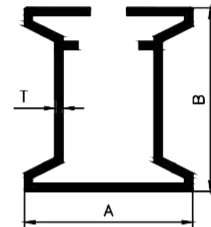

Sr.No.	Section No.	A	B	T	Wt. Kg/Mtr.
1	11750	55.00	60.00	2.60	1.697

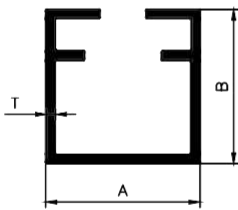

Sr.No.	Section No.	A	B	T	Wt. Kg/Mtr.
1	11751	40.00	40.00	2.40	0.995

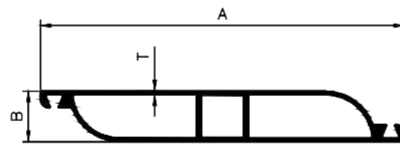

Sr.No.	Section No.	A	B	T	Wt. Kg/Mtr.
1	11752	108.00	15.00	1.10	0.843

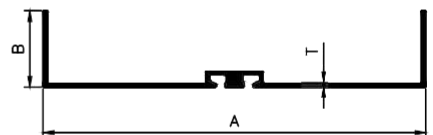

Sr.No.	Section No.	A	B	T	Wt. Kg/Mtr.
1	11753	125.00	25.00	1.20	0.795

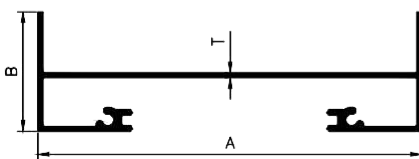

Sr.No.	Section No.	A	B	T	Wt. Kg/Mtr.
1	11754	125.00	39.00	1.50	1.213

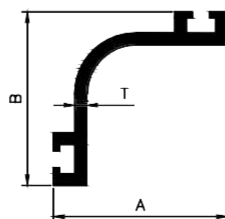

Sr.No.	Drawing No.	A	B	T	Wt. Kg/Mtr.
1	11761	28.40	28.40	1.90	0.309

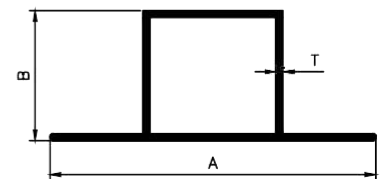

Sr.No.	Section No.	A	B	T	Wt. Kg/Mtr.
1	11778	70.00	28.00	1.50	0.607

AHU SECTIONS

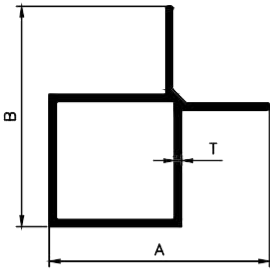

Sr.No.	Section No.	A	B	T	Wt. Kg/Mtr.
1	11779	50.00	50.00	1.60	0.653

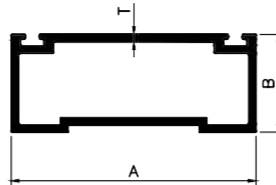

Sr.No.	Section No.	A	B	T	Wt. Kg/Mtr.
1	11780	50.00	20.00	1.50	0.595

INDUSTRIAL SECTIONS

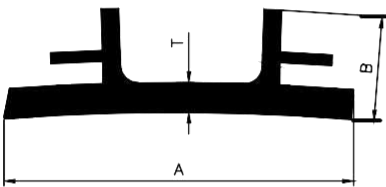

Sr.No.	Section No.	A	B	T	Wt. Kg/Mtr.
1	11704	100.50	30.00	8.50	3.075

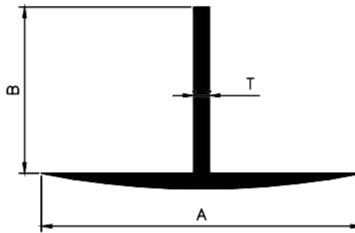

Sr.No.	Section No.	A	B	T	Wt. Kg/Mtr.
1	12183	125.00	65.00	6.00	2.405

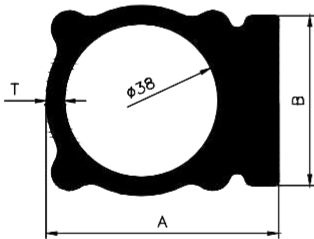

Sr.No.	Section No.	A	B	T	Wt. Kg/Mtr.
1	11706	57.50	42.00	4.50	3.463

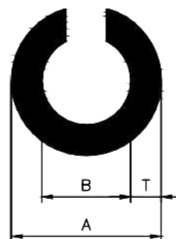

Sr.No.	Section No.	A	B	T	Wt. Kg/Mtr.
1	11701	∅18.5	∅11.0	3.75	0.417
2	11702	∅21.0	∅13.5	3.75	0.487

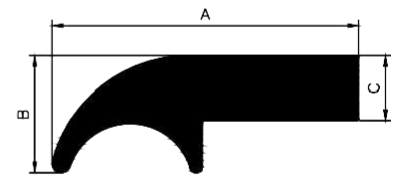

Sr.No.	Section No.	A	B	C	Wt. Kg/Mtr.
1	11703	50.00	19.00	10.50	1.384

DSL BUSBAR SECTION

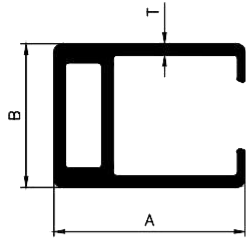

Sr.No.	Section No.	A	B	T	Wt. Kg/Mtr.
1	11746	20.00	15.00	1.20	0.237

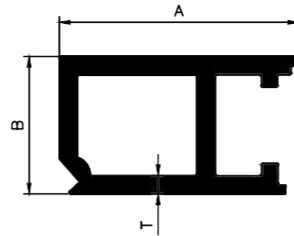

Sr.No.	Section No.	A	B	T	Wt. Kg/Mtr.
1	11747/A	26.10	15.00	2.00	0.395

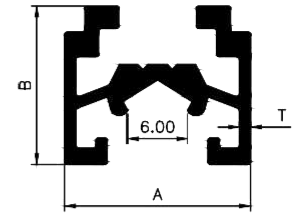

Sr.No.	Section No.	A	B	T	Wt. Kg/Mtr.
1	11705	18.40	15.70	1.10	0.280
2	11763	18.40	15.70	1.30	0.294

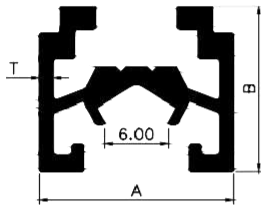

Sr.No.	Section No.	A	B	T	Wt. Kg/Mtr.
1	11768	18.40	15.70	1.30	0.286

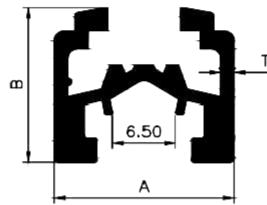

Sr.No.	Section No.	A	B	T	Wt. Kg/Mtr.
1	11745	18.00	16.00	1.40	0.314

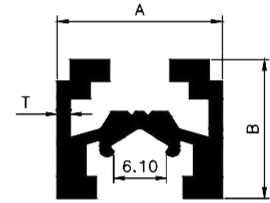

Sr.No.	Section No.	A	B	T	Wt. Kg/Mtr.
1	11748	19.00	16.00	1.50	0.369

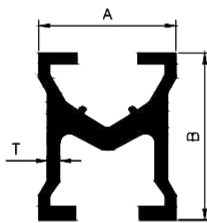

Sr.No.	Section No.	A	B	T	Wt. Kg/Mtr.
1	11749	28.00	34.00	2.50	0.888

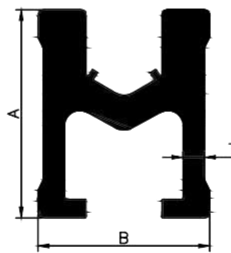

Sr.No.	Section No.	A	B	T	Wt. Kg/Mtr.
1	11765	34.00	28.00	3.50	1.262

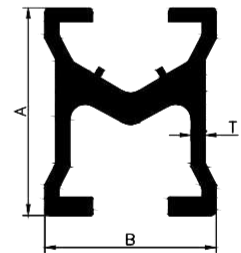

Sr.No.	Section No.	A	B	T	Wt. Kg/Mtr.
1	11766	34.00	28.00	2.30	0.900

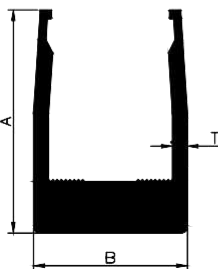

Sr.No.	Section No.	A	B	T	Wt. Kg/Mtr.
1	11767	52.00	35.75	3.50	1.852

INDUSTRIAL SECTIONS

LADDER SECTION

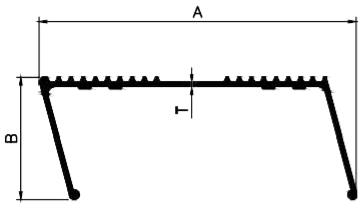

Sr.No.	Section No.	A	B	T	Wt. Kg/Mtr.
1	11782	103.66	40.00	1.50	0.862

LADDER SECTION

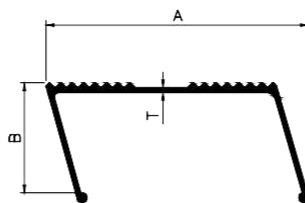

Sr.No.	Section No.	A	B	T	Wt. Kg/Mtr.
1	11783	85.39	39.00	1.50	0.758

DOCTOR BLADE

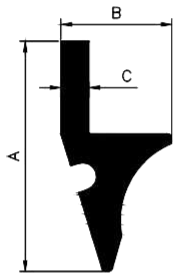

Sr.No.	Section No.	A	B	C	Wt. Kg/Mtr.
1	11733	124.22	60.00	15.00	6.853

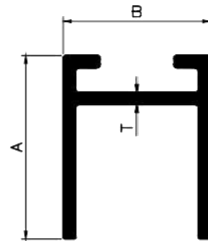

Sr.No.	Section No.	A	B	C	Wt. Kg/Mtr.
1	23024	15.00	12.00	1.00	0.118

PILLAR PROFILE

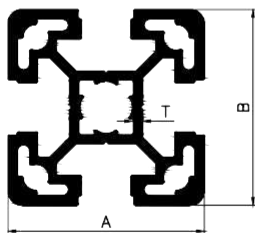

Sr.No.	Section No.	A	B	T	Wt. Kg/Mtr.
1	23029	40.00	40.00	1.80	1.465

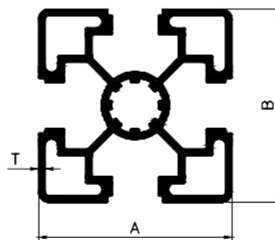

Sr.No.	Section No.	A	B	T	Wt. Kg/Mtr.
1	23036	45.00	45.00	1.50	1.383

DOOR CLOSER SECTIONS

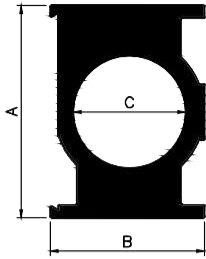

Sr.No.	Section No.	A	B	C	Wt. Kg/Mtr.
1	23031	55.00	40.00	29.20	3.226

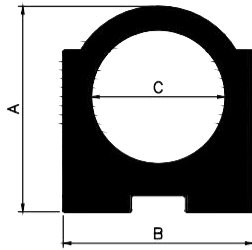

Sr.No.	Section No.	A	B	C	Wt. Kg/Mtr.
1	23032	39.50	36.60	25.80	2.050

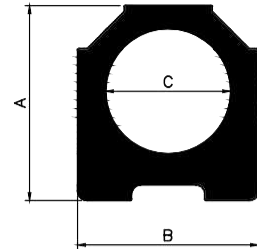

Sr.No.	Section No.	A	B	C	Wt. Kg/Mtr.
1	23023	39.80	37.00	25.60	2.160

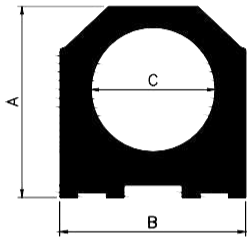

Sr.No.	Section No.	A	B	C	Wt. Kg/Mtr.
1	14942	39.00	38.00	25.50	2.252

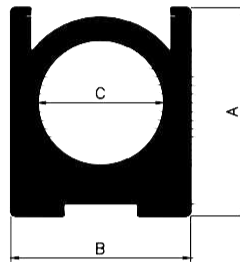

Sr.No.	Section No.	A	B	C	Wt. Kg/Mtr.
1	23039	42.50	36.60	25.60	2.378

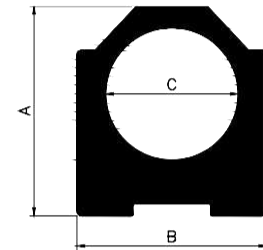

Sr.No.	Section No.	A	B	C	Wt. Kg/Mtr.
1	23043	40.30	36.40	25.50	2.143

HEATSINK SECTIONS

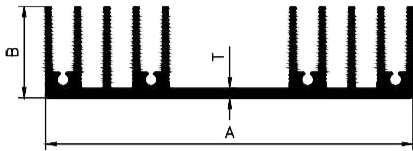

Sr.No.	Section No.	A	B	T	Wt. Kg/Mtr.
1	14203	100.00	25.00	2.60	1.759

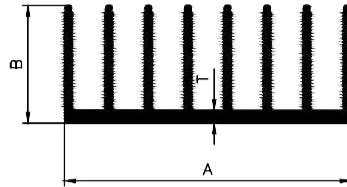

Sr.No.	Section No.	A	B	T	Wt. Kg/Mtr.
1	14204	97.60	40.00	2.60	2.934

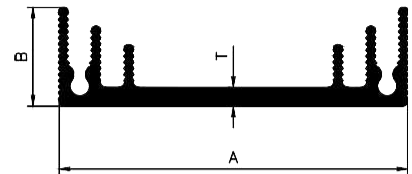

Sr.No.	Section No.	A	B	T	Wt. Kg/Mtr.
1	14205	57.00	16.10	3.00	0.658

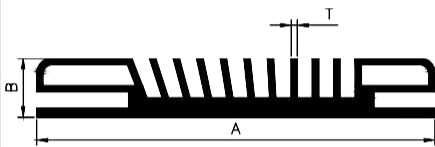

Sr.No.	Section No.	A	B	T	Wt. Kg/Mtr.
1	11653	130.00	19.00	2.00	3.170

BUSBODY SECTIONS

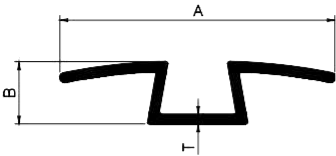

Sr.No.	Section No.	A	B	T	Wt. Kg/Mtr.
1	15522	34.50	7.80	1.20	0.162

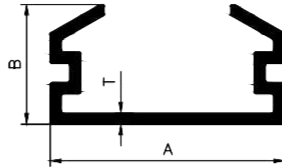

Sr.No.	Section No.	A	B	T	Wt. Kg/Mtr.
1	ART 12933	32.20	16.50	1.50	0.321

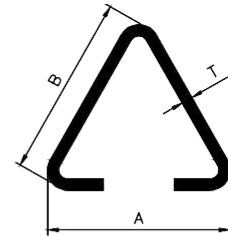

Sr.No.	Section No.	A	B	T	Wt. Kg/Mtr.
1	ART 12934	25.40	25.40	1.50	0.254

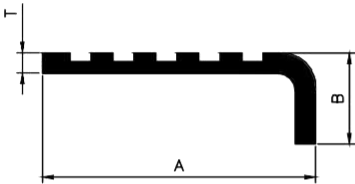

Sr.No.	Section No.	A	B	T	Wt. Kg/Mtr.
1	ART 12936	38.10	12.70	2.80	0.303



Sr.No.	Section No.	A	B	T	Wt. Kg/Mtr.
1	ART 12937	48.00	7.60	2.00	0.330

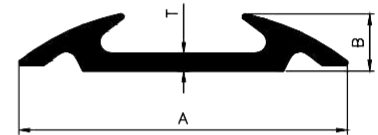

Sr.No.	Section No.	A	B	T	Wt. Kg/Mtr.
1	ART 12938	29.50	5.10	1.60	0.167

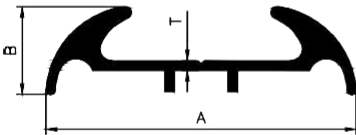

Sr.No.	Section No.	A	B	T	Wt. Kg/Mtr.
1	ART 12939	52.00	14.70	1.60	0.527

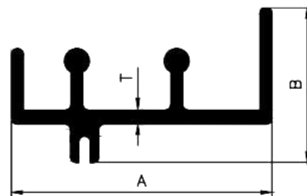

Sr.No.	Section No.	A	B	T	Wt. Kg/Mtr.
1	11718	47.20	28.00	2.50	0.715

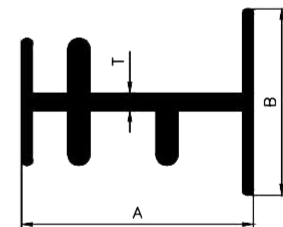

Sr.No.	Section No.	A	B	T	Wt. Kg/Mtr.
1	11719	47.36	38.00	3.60	1.178

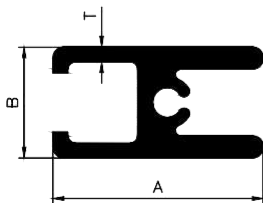

Sr.No.	Section No.	A	B	T	Wt. Kg/Mtr.
1	11720	28.50	15.00	2.00	0.523



Sr.No.	Section No.	A	B	T	Wt. Kg/Mtr.
1	11721	31.20	2.35	1.20	0.153

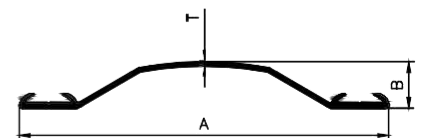

Sr.No.	Section No.	A	B	T	Wt. Kg/Mtr.
1	11722/A	127.00	16.00	2.00	0.774

BUSBODY SECTIONS

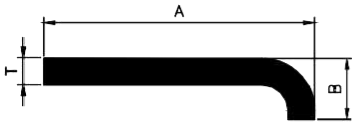

Sr.No.	Section No.	A	B	T	Wt. Kg/Mtr.
1	11723	31.00	7.00	3.00	0.267

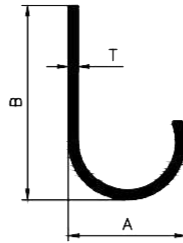

Sr.No.	Section No.	A	B	T	Wt. Kg/Mtr.
1	11724	19.04	31.70	1.60	0.228

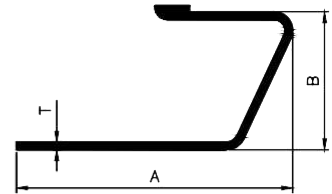

Sr.No.	Section No.	A	B	T	Wt. Kg/Mtr.
1	11725	50.00	25.00	1.40	0.350

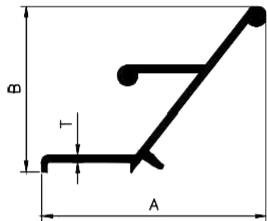

Sr.No.	Section No.	A	B	T	Wt. Kg/Mtr.
1	11726	68.00	50.00	2.00	0.770

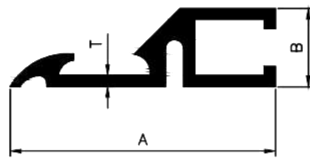

Sr.No.	Section No.	A	B	T	Wt. Kg/Mtr.
1	11727	43.30	12.80	1.80	0.455



Sr.No.	Section No.	A	B	T	Wt. Kg/Mtr.
1	11728	127.00	5.00	1.50	0.665

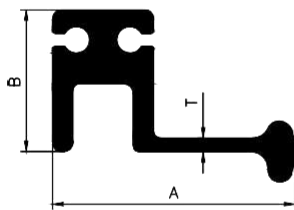

Sr.No.	Section No.	A	B	T	Wt. Kg/Mtr.
1	11729	36.00	21.00	2.00	0.700

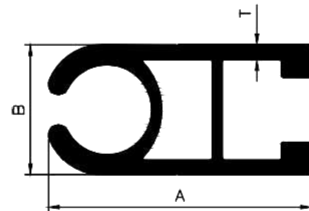

Sr.No.	Section No.	A	B	T	Wt. Kg/Mtr.
1	11730	53.00	26.00	3.00	1.377

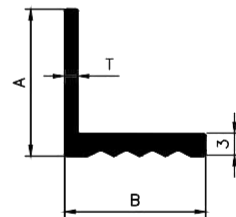

Sr.No.	Section No.	A	B	T	Wt. Kg/Mtr.
1	ARI 17094	20.00	19.20	1.80	0.223

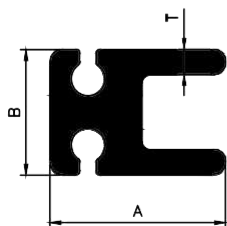

Sr.No.	Section No.	A	B	T	Wt. Kg/Mtr.
1	11737	21.00	15.00	3.00	0.515

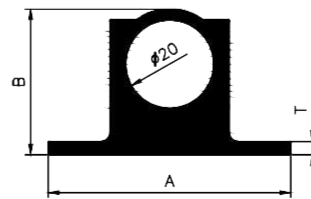

Sr.No.	Section No.	A	B	T	Wt. Kg/Mtr.
1	ARI 17093	55.00	33.00	3.00	1.675

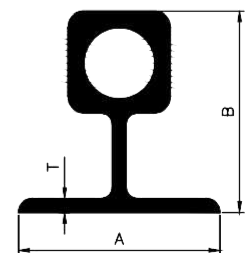

Sr.No.	Section No.	A	B	T	Wt. Kg/Mtr.
1	15501	73.00	73.00	5.00	3.590

BUSBODY SECTIONS

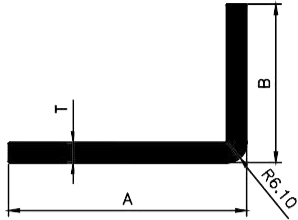

Sr.No.	Section No.	A	B	T	Wt. Kg/Mtr.
1	ANG 15502	76.20	50.80	6.40	2.062

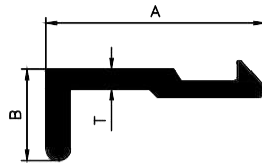

Sr.No.	Section No.	A	B	T	Wt. Kg/Mtr.
1	15503	27.50	11.50	2.50	0.258

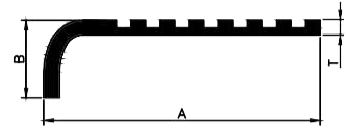

Sr.No.	Section No.	A	B	T	Wt. Kg/Mtr.
1	15504	57.00	16.00	3.15	0.484

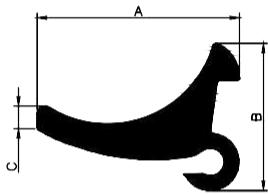

Sr.No.	Section No.	A	B	C	Wt. Kg/Mtr.
1	15505	27.50	20.00	3.09	0.479

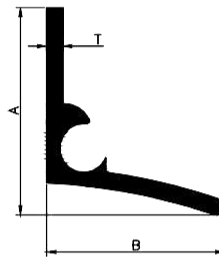

Sr.No.	Section No.	A	B	T	Wt. Kg/Mtr.
1	15506	38.50	33.00	3.00	0.551

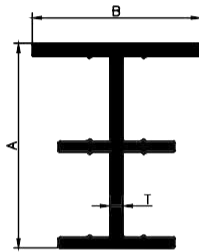

Sr.No.	Section No.	A	B	T	Wt. Kg/Mtr.
1	15507	39.50	32.50	2.50	0.690

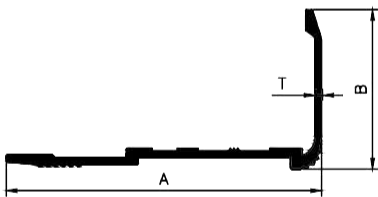

Sr.No.	Section No.	A	B	T	Wt. Kg/Mtr.
1	15508	68.20	34.50	1.50	0.488

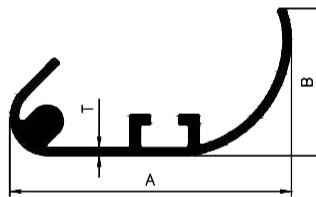

Sr.No.	Section No.	A	B	T	Wt. Kg/Mtr.
1	15509	51.50	27.00	1.50	0.538



Sr.No.	Section No.	A	B	T	Wt. Kg/Mtr.
1	15510	49.60	7.00	1.80	0.362

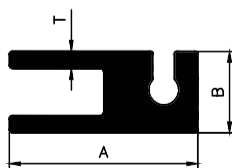

Sr.No.	Section No.	A	B	T	Wt. Kg/Mtr.
1	15511	22.00	9.50	2.00	0.355

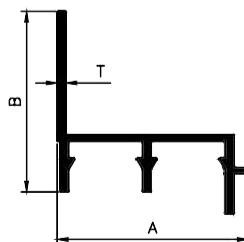

Sr.No.	Section No.	A	B	T	Wt. Kg/Mtr.
1	15512	43.35	41.00	2.00	0.559

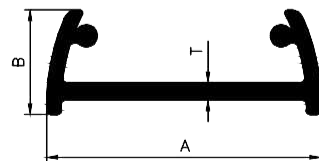

Sr.No.	Section No.	A	B	T	Wt. Kg/Mtr.
1	15513	19.00	7.25	1.20	0.106

BUSBODY SECTIONS

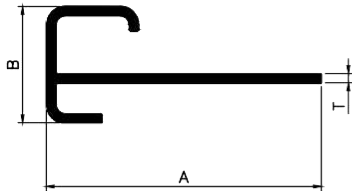

Sr.No.	Section No.	A	B	T	Wt. Kg/Mtr.
1	15514	45.00	19.00	1.50	0.336

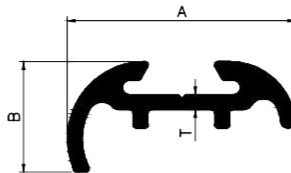

Sr.No.	Section No.	A	B	T	Wt. Kg/Mtr.
1	15518	31.00	15.00	2.00	0.354

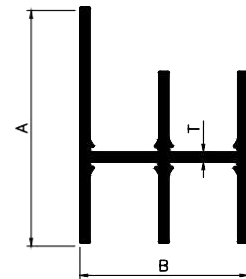

Sr.No.	Section No.	A	B	T	Wt. Kg/Mtr.
1	15520	55.00	39.10	2.30	1.058

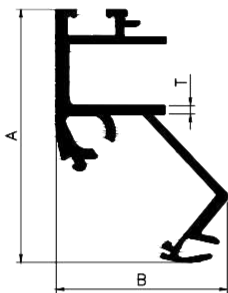

Sr.No.	Section No.	A	B	T	Wt. Kg/Mtr.
1	22000	82.56	56.15	2.50	1.766

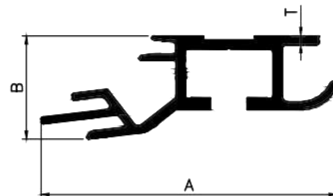

Sr.No.	Section No.	A	B	T	Wt. Kg/Mtr.
1	22001	80.63	28.00	2.50	1.168

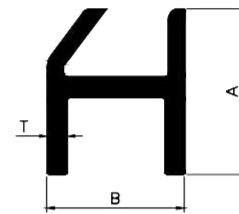

Sr.No.	Section No.	A	B	T	Wt. Kg/Mtr.
1	22004	15.00	12.50	1.80	0.183

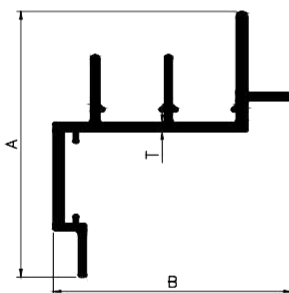

Sr.No.	Section No.	A	B	T	Wt. Kg/Mtr.
1	22005	51.15	45.75	1.80	0.640

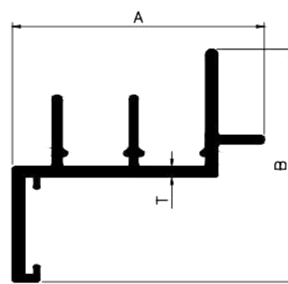

Sr.No.	Section No.	A	B	T	Wt. Kg/Mtr.
1	22006	45.75	42.15	1.80	0.598

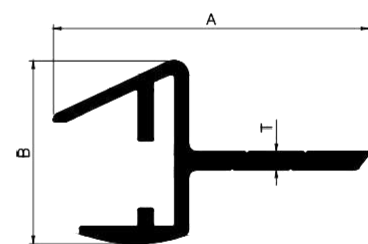

Sr.No.	Section No.	A	B	T	Wt. Kg/Mtr.
1	22007	43.10	24.90	2.50	0.472

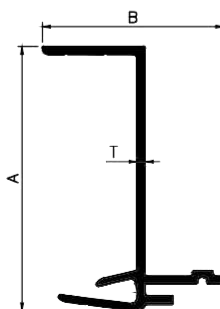

Sr.No.	Section No.	A	B	T	Wt. Kg/Mtr.
1	22008	67.00	46.00	2.00	0.769

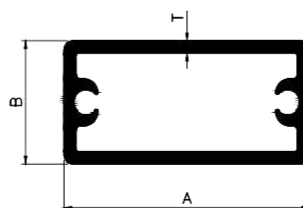

Sr.No.	Section No.	A	B	T	Wt. Kg/Mtr.
1	22009	40.00	20.00	2.00	0.662

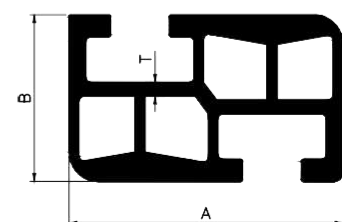

Sr.No.	Section No.	A	B	T	Wt. Kg/Mtr.
1	22010	56.00	34.00	2.80	2.071

ALL DIMENSIONS ARE IN MM.

WEIGHT TOLERANCES ± 7 TO 10%

MAY 2020

PAGE 43

Ratnashri Section No	Page	Ratnashri Section No	Page	Ratnashri Section No	Page	Ratnashri Section No	Page	Ratnashri Section No	Page	Ratnashri Section No	Page
10001	01A	11006	02	11316	05	12012	10	12166	09	12544	15
10002	01	11009	02	11401	03	12015	10	12166/A	09	12651	11
10003	01	11012	02	11402	03	12018	10	12167	09	12652	08
10004	01	11015	02	11403	03	12021	13	12167/A	09	12655	08
10005	01	11016	02	11404	03	12024	13	12168	30	12656	08
10006	01	11019	02	11407	03	12027	13	12169	30	12657	08
10007	01	11021	02	11408	03	12030	13	12170	10	12658	19
10008	01	11022	02	11409	03	12033	13	12171	10	12659	21
10009	01	11023	02	11410	03	12035	13	12172	10	12660	15
10010	01	11025	02	11411	03	12036	13	12173	10	12663	19
10011	01	11026	02	11412	03	12039	13	12174	11	12664	09
10012	01	11027	02	11472	04	12041	13	12175	11	12665	12
10013	01	11028	02	11484	01	12042	13	12176	11	12666	12
10014	01	11029	02	11489	01	12045	13	12177	14	12667	8
10015	01	11031	02	11508	04	12046	13	12178	14	12670	16A
10016	01	11032	02	11532	01	12047	13	12179	13	12671	16A
10017	01	11033	02	11541	04	12048	13	12180	13	12672	18
10018	01	11034	02	11601	33	12049	13	12181	31	12673	16
10019	01	11035	02	11602	33	12050	13	12182	31	12674	16
10020	01	11036	02	11653	39	12051	13	12183	36A	12676	18
10022	01	11037	02	11701	36A	12052	13	12184	11	12677	15A
10023	01	11038	02	11702	36A	12054	13	12185	11	12680	8
10024	01	11038/A	02	11703	36A	12055	13	12187	29	12683	15A
10025	01	11039	02	11704	36A	12057	13	12188	15	12684	12
10026	01	11040	02	11705	37	12060	14	12189	15	12685	12
10027	01	11041	02	11706	36A	12063	11	12190	15	12686	12
10028	01	11042	02	11707	36	12066	11	12191	15	12689	18
10029	01	11043	02	11708	36	12069	11	12192	15	12694	14B
10030	01	11044	02	11709	36	12072	11	12193	16	12695	8
10031	01	11045	02	11710	36	12075	07	12194	16	12696	8
10032	01	11046	02	11716	36	12078	07	12195	16	12701	8
10033	01A	11047	02	11718	40	12081	07	12197	08	12702/B	14B
10034	01	11048	02	11719	40	12084	07	12198	08	12703	15
10035	01A	11049	02	11720	40	12087	08	12199	08	12704	16
10036	01	11050	02	11721	40	12090	08	12200	33	12707/A	9
10037	01	11051	02	11722/A	40	12091	08	12202	13	12708	9
10038	01	11052	02	11723	41	12093	08	12203	30	12709	9
10039	01	11053	02	11724	41	12096	08	12204	30	12710	12
10040	01	11054	02	11725	41	12099	14	12205	11	12711	12
10041	01	11055	02	11726	41	12100	14	12206	11	12712	9
10042	01A	11056	02	11727	41	12102	14	12207	11	12713	09
10043	01A	11057	02	11728	41	12103	14	12208	10	12714	09
10045	01	11058	02	11729	41	12105	14	12209	10	12719/B	09
10046	01	11059	02	11730	41	12108	14	12210	28	12720/B	09
10047	01	11060	02	11731	35	12111	28	12211	07	12734	08
10048	01	11061	02	11732	35	12114	28	12212	07	12735	08
10049	01A	11062	02	11733	38	12115	08	12215	14B	12736	12
10050	01	11063	02	11734	35	12116	08	12216	7	12737	12
10051	01A	11064	02	11735	35	12117	08	12351	07	12750	15A
10052	01A	11065	02	11736	35	12118	07	12352	10	12751	15A
10053	01	11066	02	11737	41	12119	07	12353	10	12759	25
10054	01	11067	02	11738	35	12121	13	12354	07	12801	14
10055	01	11068	02	11739	35	12122	13	12355	07	12802	13
10056	01	11069	02	11744	35	12123	13	12356	07	12803	13
10057	01A	11070	02	11745	37	12124	13	12357	07	12804	13
10059	01	11071	02	11746	37	12125	14	12358	10	12805	13
10060	01	11072	02	11747	37	12131	10	12359	10	12806	14
10061	01	11201	32	11748	37	12132	10	12361	14B	12807	14
10062	01	11202	32	11749	37	12134	12	12362	10	12808	13
10063	01	11203	32	11750	36	12136	15A	12363	10	12809	13
10064	01	11204	32	11751	36	12137	15A	12451	7	12810	13
10066	01	11205	32	11752	36	12138	15B	12452	07	12811	13
10067	01	11206	32	11753	36	12139	15A	12453/A	11	12812	13
10068	01	11207	32	11754	36	12140	29	12454/A	11	12813	13
10069	01A	11208	32	11761	36	12141	29	12455	14B	12814	13
10070	01	11214	32	11763	37	12143	29	12481	11	12815	13
10071	01	11215	32	11765	37	12146	29	12482	11	12816	13
10072	01	11301	05	11766	37	12151	11	12501	07	12817	13
10073	01	11302	05	11767	37	12152	11	12502	15	12818	14
10075	01	11303	05	11768	37	12153	11	12515	25	12819	14
10076	01	11304	05	11778	36	12154	11	12516	16A	12820	13
10077	01	11305	05	11779	36A	12155	14	12517	16A	12821	13
10078	01	11306	05	11780	36A	12156	12	12518	16A	12822	13
10079	01	11307	05	11782	38	12157	12	12525	15A	12823	13
10080	01	11308	05	11783	38	12158	31	12526	15A	12826	14
10081	01	11309	05	12001	10	12159	31	12527	15A	12827	13
10082	01	11310	05	12003	10	12160	31	12528	15A	12828	13
10083	01	11311	05	12004	10	12161	28	12529	15	12829	13
10084	01	11312	05	12006	10	12162	25	12535	18	12830	13
10085	01	11313	05	12007	10	12163	05	12536	15A	12831	13
10086	01	11314	05	12009	10	12164	09	12538	15	12836	13
11003	02	11315	05	12010	10	12165	13	12541	15	12837	13
										12838	13

Ratnashri Section No	Page	Ratnashri Section No	Page	Ratnashri Section No	Page	Ratnashri Section No	Page	Ratnashri Section No	Page	Ratnashri Section No	Page
12839	13	13222	03	14055	29	15518	43	17130/A	31	19021	20
12840	14	13223-A	03	14056	29	15520	43	17114	24	19022	20
12841	13	13224-A	03B	14057	29	15521	26	17115	24	19026/A	22A
12842/A	14A	13225	03B	14058	29	15522	40	17116	24	19027/A	22A
12901	27	13226	03	14059	30	15601	35	17117	24	19028	22A
12902	31	13227	03	14060	30	15603	35	17118	24	19029	22A
12903	34	13228	03	14061	30	15607	35	17119	24	19047	22
12904	6	13229	03A	14062	30	15608	35	17120	28	19051	23
12917	31	13230	03	14063	29	15609	35	17121	28A	19502	27A
12918	23A	13231	03	14064	29	15610	35A	17122	28A	19503	27A
12919	23A	13232	03	14065	29	15611	35A	17123	28A	19504	26
12920	23A	13233	03	14070	29	15614	35A	17129	14A	19505	27A
12921	23A	13234	03	14071	29	16000	02	17141	28	19506	27A
12922	23A	13235	03	14073	30	16001	04	17143	28	19512	27
12923	15A	13236	03	14074	30	16002	04	17144	23A	19513	27
12924	15A	13237	03	14088	30	16003	04	17175	31	19514	27
12925	15A	13237/A	03	14089	30	16004	04	17176	27B	19900	28B
12926	28	13237/B	03	14101	6	16005	04	17177	27B	19901	28B
12927	28	13238	03	14102	6	16006	04	17178	27B	19902	28B
12928	28	13239	03A	14103	6	16007	04	17179	13	19903	28B
12929	25	13240	03	14104	6	16008	04	17181	25	19904/A	28B
12933	40	13241	03	14108	29	16009	02	17209	12	19905	28B
12934	40	13242	03	14203	39	16010	02	17210	12	20000	28
12935	05	13243	03	14204	39	16201	4	17211	10	20001	28
12936	40	13244	03	14205	39	16401	05	17212	10	21500	35A
12937	40	13245	03	14678	5	16402	05	17213	14A	21508	35A
12938	40	13246	03	14942	38A	16403	05	17215	9	21511	35B
12939	40	13247	03B	15001	03	16404	05	17216	8	21512	35B
12940	30	13248	03B	15002	03	16601	04	17233	28A	21513	35A
12941	30	13249	03B	15003	03	16602	04	17234	14	21514	35B
12942	17	13250	03A	15004	03	16805	3B	17235	14	21515	35B
12943	17	13251	03	15005	03	16806	3B	17236	14	21516	35A
12944	17	13252	03	15006	03	16807	3B	17237	14	21517	35A
12957	26	13253	03	15007	03	16808	3A	17238	28A	21518	35A
12958	26	13254	03	15008	03	16816	3A	17257	02	21519	35A
12959	26	13255	03	15009	03	16817	3A	17258	31	21520	35A
12960	26	13256	03	15010	03A	17001	25	17259	31	22000	43
12961	15B	13257	03	15011	03	17007	22	17263	31A	22001	43
12962	04	13258	03	15012	03	17008	21	17264	31A	22004	43
12963	31	13259	03	15013	03	17009	25	17272	28	22005	43
12979	22	13260	03	15014	03	17010	34	17274	28B	22006	43
12980	22	13262	03	15015/A	03	17023	21	17275	28B	22007	43
12981	22	13263/A	03	15016	03	17024	25	17302	24	22008	43
12982	22	13264	03	15017	03	17031	28	17303	24	22009	43
12983	21	13265/A	03	15018	03	17033	20	17304	24	22010	43
12984	21	13266	03	15019/A	03	17034	15B	17305	24	23011	05
12985	21	13266/A	03	15020	03	17035	15	17904	16	23023	38A
12986	21	13267	03B	15021	03	17043	26	17905	17	23024	38
12987	34	13268	03	15022	03	17044	26	17910	28A	23029	38
12988	02	13269	03	15023	03	17045	28A	17912	22	23031	38A
12999	34	13270	03	15024/A	03	17046	26	17913	22	23032	38A
13000	34	13271	03	15025	03	17047	15B	17915	15B	23033	35A
13001	05	13272	03A	15026	03	17048	15B	17916	14B	23036	38
13002	05	13273	03	15027	03	17050	20	17917	14B	23039	38A
13003	05	13501	04	15027/A	03A	17054	25	17918	20	23043	38A
13004	05	13502	04	15028	03	17055	28	17926	22A	90022	01
13005	05	13503	04	15029	03	17056	19	17927	22A	90084	01
13006	05	13504	04	15030	03	17057	14	17943	15B	92000	05
13007	05	13505	04	15031	03	17058	19	17951	27B	92001	05
13008	05	13506	04	15032	03	17059	19	17954	23	92002	05
13011	05	13507	04	15033	03	17060	19	17955	23	92601	04
13012	05	13508	04	15034	03	17061	15B	17965	15B	92802	04
13013	05	13509	04	15035	03	17063	23	17967	14A	92803	04
13015	05	13510	04	15036	03	17067	16A	18008	13	92804	04
13018	05	13512	04	15037	03	17068	16A	18009	13		
13202	03	13513	04	15038	03	17069	16A	18010	13		
13203	03	13514	04	15039	03	17070	18	18011	14A		
13204	03	13515	04	15040	03	17071	27	18012	13		
13205	03	13517	04	15041	03	17072	18	18041	14A		
13206	03	13601	28B	15042	03	17073	14	18042	14A		
13207	03	13751	06	15043	03	17074	28	19001	20		
13208	03	13752	06	15501	41	17075	27	19002	20		
13209	03	13753	06	15502	42	17076	27	19003	19		
13210	03	13754	06	15503	42	17077	27	19004	19		
13211	03	13755	06	15504	42	17078	25	19005	19		
13212	03	13756	06	15505	42	17084	16	19006	20		
13213	03	13757	06	15506	42	17088	18	19007	20		
13214	03	13758	06	15507	42	17089	18	19008	20		
13215	03	14001	33	15508	42	17090	18	19009	23		
13216	03	14002	33	15509	42	17091	20	19010	23		
13217	03	14003	33	15510	42	17092	25	19011	23		
13218	03	14004	33	15511	42	17093	41	19012	21		
13219	03	14007	33	15512	42	17094	41	19013	20		
13220	03A	14042	33	15513	42	17098	25	19014	20		
13221	03	14053	29	15514	42	17101	31				